

IN THE COURT OF COMMON PLEAS
CUYAHOGA COUNTY, OHIO
CRIMINAL DIVISION

**IN RE: APPOINTMENT OF SPECIAL
PROSECUTING ATTORNEY**

SPECIAL DOCKET

**ADMINISTRATIVE JUDGE
JUDGE BRENDAN SHEEHAN**

**STATE'S MOTION FOR
APPOINTMENT OF
SPECIAL PROSECUTOR**



Now comes the State of Ohio, by and through Michael C. O'Malley, the Prosecuting Attorney for Cuyahoga County, Ohio, hereby applies to this Honorable Court for the appointment of Ohio Attorney General Dave Yost, and any of his designees, assistants or deputies, as special prosecutor to investigate and prosecute matters involving an alleged Use of Deadly Force ("UDF") investigation originating in the City of Cleveland at 3677 East 147th Street in Cuyahoga County, Ohio on April 15, 2021. This investigation is being conducted by the Office of the Cuyahoga County Sheriff.

Special prosecutors may be appointed by the Common Pleas Court in accordance with Revised Code Sections §309.10 and §2941.63. Moreover, the Court, under its inherent power, may appoint a special prosecutor whenever it comes to the Court's attention that the ability to administer justice in a fair and impartial manner could be called into question. Such a case exists when there is a conflict or appearance of conflict of interest between the parties. Where a special prosecutor has been appointed under the

Court's inherent power, that special prosecutor acts independently of the duly elected prosecutor.

Wherefore, the Prosecuting Attorney respectfully requests this Honorable Court exercise its authority and appoint Dave Yost, Ohio Attorney General, as special prosecutor to prosecute the matter involving the alleged use of deadly force investigation in Cleveland, Ohio. Should this court sign said order, upon the signing of the order appointing Attorney General Yost, a copy of said order will be provided to the Cuyahoga County Sheriff's Office to ensure that investigative materials are provided directly to Attorney General Yost.

Respectfully Submitted,



Michael C. O'Malley (89592)
Prosecuting Attorney for Cuyahoga County
Cuyahoga County Prosecutor's Office
1200 Ontario Street, 9th Floor
Cleveland, Ohio 44113
(216) 443-7800

658815

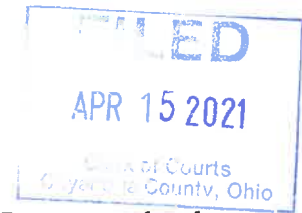

CERTIFICATE OF SERVICE

A true copy of the foregoing Application to Appoint Special Prosecutor has been filed with the Clerk of Courts and served via regular U.S. Mail, postage prepaid, this day of April 15, 2021, upon the following:

Ohio Attorney General Dave Yost
Ohio Attorney General's Office
615 West Superior Avenue, 11th Floor
Cleveland, Ohio 44113

Michael C. O'Malley (59592)
Prosecuting Attorney for Cuyahoga County
Cuyahoga County Prosecutor's Office
1200 Ontario Street, 9th Floor
Cleveland, Ohio 44113
(216) 443-7800

IN THE COURT OF COMMON PLEAS

CUYAHOGA COUNTY, OHIO

**In Re: Appointment of Special
Prosecuting Attorney**

) **SPECIAL DOCKET**
) **CASE NO. 658815**
)
) **JUDGE BRENDAN SHEEHAN**
)
)
)
)
) **ORDER**
)

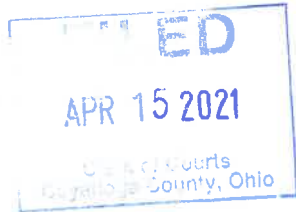

This matter came on for consideration upon the State's Motion for Appointment of a Special Prosecutor. The Court finds the Motion to be well-taken. Attorney General Dave Yost, and any of his designees, assistants or deputies, is hereby appointed special prosecutor to represent the State with the same power and authority granted by law to the Cuyahoga County Prosecutor and may utilize the support services of the Cuyahoga County Prosecutor's Office commencing April 15, 2021.

IT IS SO ORDERED.

Entered this 15th day of April 2021.



ADMINISTRATIVE JUDGE
JUDGE BRENDAN SHEEHAN
ADMINISTRATIVE JUDGE
CUYAHOGA COUNTY, OHIO

CRIME SCENE ENTRY LOG

All persons on the crime scene shall be accounted for along with their purpose for being there.
Anyone on the crime scene may be subject to interview by detectives or may be subpoenaed to the grand jury and/or any trial.

LOCATION: 4281 E 134th St

TYPE OF CRIME: Officer Involved Shooting

OPENED ON: 04/15/2021 @ 0920 HRS

CLOSED ON: _____ @ _____ HRS

BY (PRINT NAME): J. Gentile #347

BY (PRINT NAME): _____

SIGNATURE: [Signature]

SIGNATURE: _____

DATE	DEPT/ UNIT	TIME		NAME (PRINTED) / BADGE #	REASON/DUTIES
		IN	OUT		
4/15/21	CCSD	1102	1104	Harvy / #343	
4/15/21	CCSD	1102	1104	Bartczak /	
4/15/21	CCSD	1102	1104	Klous / #70	
4/15/21	CCSD	1112	1113	Klous / #70	Checking VIN # on off KP JGH 2218
4/15/21	CCSD	Did not go in		Watson / #86	Did not go in
4/15/21	CCSD	Did not go in		Sgt Devlin / #2528	Did not go in
4/15/21	CCSD	1115	1118	Gibson	
4/15/21	CCSD	1115	1118	Grooby	

INCIDENT NUMBER: 21015453

SHEET # 1 OF _____ TOTAL SHEETS

CRIME SCENE ENTRY LOG

All persons on the crime scene shall be accounted for along with their purpose for being there.
Anyone on the crime scene may be subject to interview by detectives or may be subpoenaed to the grand jury and/or any trial.

LOCATION: 4281 E. 134th St

TYPE OF CRIME: Officer Involved Shooting

OPENED ON: 04/15/2021 @ 0920 HRS

CLOSED ON: _____ @ _____ HRS

BY (PRINT NAME): J. Buntic #547

BY (PRINT NAME): _____

SIGNATURE: Jeffrey R. Buntic

SIGNATURE: _____

DATE	DEPT/ UNIT	TIME		NAME (PRINTED) / BADGE #	REASON/DUTIES
		IN	OUT		
4/15/21	CCSD	1118	1156	Nuckola	
4/15/21	Invest M.E.	1120	1156	McKenzie Madigan	
4/15/21	Invest M.E.	1120	1156	Joe Felio	
4/15/21	Invest M.E.	1120	1156	Sean Silver	
4/15/21	BCT	1124	1159	Edward Lulla	
4/15/21	Invest M.E.	1124	1156	Parsons #16	
4/15/21	BCT	1129	1143	Ornelas #138	
4/15/21	BCT	1127	1159	Boerner #135	

INCIDENT NUMBER: 21015453

SHEET # 2 OF _____ TOTAL SHEETS



CRIME SCENE ENTRY LOG



All persons on the crime scene shall be accounted for along with their purpose for being there. Anyone on the crime scene may be subject to interview by detectives or may be subpoenaed to the grand jury and/or any trial.

LOCATION: 4281 E. 134th Street

TYPE OF CRIME: Officer Involved Shooting

OPENED ON: 04/15/2021 @ 0920 HRS.

CLOSED ON: _____ @ _____ HRS.

BY (PRINT NAME) J. Gentile #347

BY (PRINT NAME) _____

SIGNATURE J. Gentile

SIGNATURE _____

DATE	DEPT/ UNIT	IN	OUT	NAME (PRINTED) / BADGE #	REASON / DUTIES
4/15/21	M.E	1138	1140	Parsons #6	
4/15/21	M.E	1140	1156	Parsons #16	
4/15/21	I.A Cie	1141	1156	Bennett	
4/15/21	I.A	1141	1142	Schwabs #9205	
4/15/21	M.E	1141	1143	Marvel	
4/15/21	I.A	1143	1156	Schwabs #9205	
4/15/21	CCSD	1143	1156	Barczak	
4/15/21	M.E	1143	1156	Marvel	
4/15/21	CCSD	1144	1201	CAP. Jerome	
4/15/21	CPD Hom. i. d.	1145	1156	Gomez	
4/15/21	BCI	1146	1149	Ornelas #138	
4/15/21	BCI	1155	1241	Ornelas #138	
4/15/21	CCSD	1157	1204	Barczak	

21015453



CRIME SCENE

All persons on the crime scene shall be accounted for along with their purpose for being there. Anyone on the crime scene may be subject to interview by detectives or may be subpoenaed to the grand jury and/or any trial.

LOCATION: 4281 E. 134th st

TYPE OF CRIME: Officer Involved Shooting

OPENED ON: 04/15/2021 @ 0920 HRS.

CLOSED ON: _____ @ _____ HRS.

BY (PRINT NAME) J. Gentile #347

BY (PRINT NAME) _____

SIGNATURE *J. Gentile*

SIGNATURE _____

DATE	DEPT/ UNIT	IN	OUT	NAME (PRINTED) / BADGE #	REASON / DUTIES
4/15/21	Homicide cle	1158	1204	Gomez	
4/15/21	IA cle	1158	1204	Bennett	
4/15/21	CCSD	1158	1201	Nuckda	
4/15/21	IA cle	1158	1204	Schwabs #9205	
4/15/21	BCI	1205	1230	Boerner #135	
4/15/21	CCSD	1212	1241	Nuckda	
4/15/21	CCSD	1213	1241	Lt. Caraballo	
4/15/21	CCSD	1216	1234	Bartczek	
4/15/21	BCI	1232	1241	Boerner #135	
4/15/21	BCI	1244	1311	Ornelas #138	
4/15/21	BCI	1244	1311	Boerner #135	
4/15/21	CCSD	1316	1316	Lt. Caraballo	
4/15/21	CCSD	1354	1356	Cap. Jerome	

21015453

SUPPLEMENTARY REPORT

Cleveland Division of Police

DATE OF THIS REPORT: April 19, 2021

COMPLAINT NO.

2021-110000

UDFIT 21-03

SUBJECT: Felonious Assault on Police Officer On-Duty Shooting/Police Intervention(shooting)/Abated by Death/Gun Confiscation x3/Named Suspect

VICTIM	ADDRESS	PHONE	AGE	SEX	RACE	M-S C
PO. Daniel Piper #1113	9333 Kinsmans/4 th District Basic Patrol		40	M	WH	
ADDRESS OF OCCURRENCE	TYPE OF PLACE		ZONE			
4281 E. 134	Rear yard		4-7			
TIME OF OCCURRENCE	DATE OF OCCURRENCE		DAY OF WEEK			
Approximately 0823hrs.	April 15, 2021		Thursday			

Page 1 of 2

ORIGINAL INVESTIGATION

ASSIGNMENT

On Thursday, April 15, 2021, while assigned as Crime Scene Unit #8116, and assisted by Det. Manson #632, and Det. Robinson #1564 of the Crime Scene Unit. I received this assignment via Cleveland Police Radio at 0842hrs, as an On-Duty officer involved in a shooting. I arrived at 0918hrs, and conferred with Lt. Rauscher #8534, Sgt. Rini #9051, and Sgt. Cloud #9255 of The Cleveland Police Crime Scene Unit, and Deputy Divin #191 of the Cuyahoga County Sheriff's Office.

For further personnel on scene refer to the crime scene log.

WEAPON

Weapon #1: Smith & Wesson, MP9 SHIELD, bearing serial #HMP6782, with an inserted magazine. Det. Robinson #1564 retrieved this weapon from the right cargo pocket of PO. Piper #1113 uniform pants at 0934hrs, and placed in a gun box. This weapon remained in my custody until Agent Boerner #135 of The Ohio Bureau of Criminal Investigation took possession of it at 1107hrs.

EVIDENCE

All evidence collected, packaged and released to the Cuyahoga County Sheriff's Office on scene to Deputy Divin #191.

- 1.) Axon Body Camera #X81033530 from PO. Cedeno #483 @0951hrs.
- 2.) Axon Body Camera #X31010295 from PO. Trinh #505 @0952hrs.
- 3.) Axon Body Camera #X6032396L from PO. Castaglione #261 @0953hrs.
- 4.) Axon Body Camera #X81077566 from PO. Brown #1393 @0953hrs.
- 5.) Axon Body Camera #X81090993 from PO. Lampkin #2462 @0957hrs.
- 6.) Axon Body Camera #X81043730 from PO. Piper#1113 @0959hrs.

INVESTIGATING OFFICERS

Det. MICHAEL L. HALE #1187

PLATOON

1st

CAR

8116

APPROVED BY

Joe Rini Sgt #9051

WEATHER

CLEAR

RAIN

CLOUDY

SNOW

TEMP

40°

WIN 9 MPH

A.I.U

S.I.U

REQUESTED

NOT REQUESTED

ON SCENE

ASSIGNMENT RECEIVED FROM:

RADIO

DISTRICT Det. Bur.

TIME ASSIGNED

COMPLETED

SUPPLEMENTARY REPORT

Cleveland Division of Police

DATE OF THIS REPORT: April 19, 2021

COMPLAINT NO.

2021-110000

UDFIT 21-03

SUBJECT: Felonious Assault on Police Officer On-Duty Shooting/Police Intervention(shooting)/Abated by Death/Gun Confiscation x3/Named Suspect

VICTIM	ADDRESS	PHONE	AGE	SEX	RACE	M-S C
PO. Daniel Piper #1113	9333 Kinsmans/4 th District Basic Patrol		40	M	WH	
ADDRESS OF OCCURRENCE	TYPE OF PLACE		ZONE			
4281 E. 134	Rear yard		4-7			
TIME OF OCCURRENCE	DATE OF OCCURRENCE		DAY OF WEEK			
Approximately 0823hrs.	April 15, 2021		Thursday			

Page 2 of 2

ORIGINAL INVESTIGATION

The Cleveland Police Crime Scene Unit retrieved the suspect's weapon and the Axon Body Cameras from the sidewalk and street in front 4281 E. 134th. The Cleveland Police Crime Scene Unit played no further role in the processing of this scene.

WEATHER

The weather, as reported by www.weather.gov, for **Thursday, April 15, 2021** at **0841hrs.**, Partly Cloudy skies, SSW wind @9mph, visibility of 10 miles, and an air temperature 40 degrees (F).

Respectfully,

Det. MICHAEL L. HALE #1187
SIU #8116

INVESTIGATING OFFICERS	PLATOON	CAR	APPROVED BY		
Det. MICHAEL L. HALE #1187 	1st	8116			
WEATHER	TEMP	WIN	A.I.U.	REQUESTED	ON SCENE
<input type="checkbox"/> CLEAR <input type="checkbox"/> RAIN <input type="checkbox"/> CLOUDY <input type="checkbox"/> SNOW	40 °	9 MPH	<input type="checkbox"/> A.I.U. <input type="checkbox"/> S.I.U.	<input type="checkbox"/> REQUESTED <input type="checkbox"/> NOT REQUESTED	<input type="checkbox"/> ON SCENE <input type="checkbox"/>
ASSIGNMENT RECEIVED FROM:	TIME ASSIGNED		COMPLETED		
<input type="checkbox"/> RADIO <input type="checkbox"/> DISTRICT Det. Bur. <input type="checkbox"/>					

CLEVELAND DIVISION OF POLICE

District: Fourth * Final *

C

Day: Wednesday

Date: April 14th, 2021

Rank	Name	Assignment	Rank	Name	Assignment
O.O.S.		4S32 @2000 HRS	0707	Harris	T Desk/Lobby @2000 HRS
9288	Sgt. Cruz	P 4S33 @2000 HRS			
9272	Sgt. Maye (WDO)	S 4S34 @2200 HRS			
9143	Sgt. Edrington	T OIC @2000 HRS			

Car	Rank Name	Rank Name	Car	Rank Name	Rank Name
REPORT FOR DUTY @2100 HRS			REPORT FOR DUTY @2200 HRS		
4A31	0283 McCarthy	T 0614 Detchon	4B31	0286 McFadden	N 0938 Paridon
4A34	1850 Nezbeth	N 1276 Sheets	4B33	0629 Simko	O 0231 Russo
4A36	1784 Woods	N 0635 Ayers***	4B35	O.O.S.	
4C31	2329 Zagaria	P	4B37	2085 Moyano	O 0761 Luongo
4C37	0032 Bloxton	N	4B38	0180 Harold	T 0194 Johns
			4D32	O.O.S.	
			4D35	O.O.S.	

Vacation Days				Furlough Days			
Rank	Name	Rank	Name	Rank	Name	Rank	Name
1658	Pruitt	Q	1773 Shumpert	R	1383 Surtz	S	9104 Sgt. Moore
0066	Przybylski	Q	0820 McCartney	R	2314 Fisher	S	N F-2
0539	Sefcik	Q	1297 Munson	R	1122 Natera	S	2319 Derry
2331	Robertson***	Q	1956 Musson	R	0138 Zenz	S	T F-1
1140	Tohati	Q	0119 Soucek	R	0134 Fitchwell	S	
			1279 Kiernan	R	0981 Pesta	S	
			1157 Sedlak***	R	1058 Polichuk	S	
9281	Sgt. Wells	Q					

Rank	Name	Sick/Other	Rank	Name	OTT HRS	
0575	Swirynsky	T ADM-5	1141	Steinmetz	P -10	***WDO/X-TIME*** 9272 Sgt. Maye (WDO) S
8476	Lt. Cutlip	FSS SK	0599	Deems	P -10	
9297	Sgt. King	O SUSP				

Rank	Working	V-Day	F-Day	Sick	OTT	Other	Totals	Respectfully,
Cmdr/Capt							0	<p style="font-size: small;">P.O. Wesley Harris #707 4/15/21</p> <p style="font-size: small;">P.O. Wesley Harris # 707</p> <p style="font-size: small;">Examined and Approved: 4/15/21</p> <p style="font-size: small;">Sgt. Westley Edrington # 9143</p>
Lt.				1			1	
Sergt.	3	1	1	0	0	1	6	
P.O.	17	19	1		2	1	40	
Total	20	20	2	1	2	2	47	
Total personnel assigned to this command.....								

**CLEVELAND DIVISION OF POLICE
Daily Duty Assignments FINAL**

District: **FOURTH** Platoon: **A** Day: **THURSDAY** Date: **APRIL 15, 2021**

Rank	Name	Assignment			Rank	Name	Assignment		
8520	LT. STRONG	SS	4S12	0600HRS	0813	GRAY	I	DESK	0600 HRS
					0582	WOON	H	LOBBY	0600 HRS
9167	SGT. ALLEN	G	4S13	0700 HRS					
9281	SGT. ZEISEL	H	4S14	0800 HRS	0115	BENN	L	EXPEDITER	0700 HRS
9220	SGT. OLIVER	I	OIC	0600 HRS	1813	MUNGUIA SS DET'D TO CMDR OFFICE @0800 HRS			

Car	Rank	Name	Rank	Name	Car	Rank	Name	Rank	Name					
	Early	0700 HRS	TO	1500 HRS.		Late	0800 HRS	TO	1600 HRS					
4A13	1159	MUNKO	M	0353	PETRY	H	4B11	0458	RIVERA	H	0025	BAZDAR	M	
4A16	1393	BROWN	M	0261	CASTIGLIONE	I	4B15	0358	QUINONES	H	2121	HUSKEY	G	
4A18	2462	LAMPKIN	H	0483	CEDEÑO	J	4B17	0993	FIORITTO	Bptl S	2395	PAVLIK	Bplt	N
4C14	1222	WILLIAMS	I	Property Car		4D11	2302	MESSER	I					
4C15	0600	HAYDEN	G			4D17	0180	HAROLD	Cptl	T				
4C16	2554	VARNDELL	I	Missing Persons		4D18	325	NUSSBAUM	J					

Vacation Days (J,K)				Furlough Days						
Rank	Name	Rank	Name	Rank	Name	Rank	Name			
0670	SHINGARY	J		9301	SGT. STANTON	K				
2130	BUCCINI	J		0693	BJEKIC***	K				
				1517	KRAYNIK	K				
				1875	SCHMITZ	K				
				0594	WYNN	K				
							1661	LANE	M	F4
							2397	CHASER	G	F3
							0842	RUMA	L	F4

All personnel assigned to this command are present, on vacation or furlough except: (x) No Exceptions
All OT-2 cards have been made.

Rank	Name	Sick/Other	Rank	Name	-8 OTT	Rank	Name	Working Day Off
2241	MOONEYHAM	G SK	0529	LUCARELLI	L -8	0325	NUSSBAUM	J WDO
0840	CORRIGAN	L FR	9167	SGT. ALLEN	G -1	0483	CEDEÑO	J WDO
						993	FIORITTO	S Bplt 0800-1500 HS X-TIME
						2395	PAVLIK	N Bplt 0800-1400 HRS X-TIME
						0180	HAROLD	Cptl 0800-1200 HRS Ext tour

All vehicles assigned are in regular service except: (X)

Rank	Working	V-Day	F-Day	Sick	-8 OTT	Other	Totals	Respectfully,
Cmdr/Capt							0	
Lt.	1	0	0	0	0	0	1	<i>P.O. Gray #813</i>
Sgt.	3	1	0	0	0	0	4	
P.O.	20	5	3	2	2	0	32	Examined and Approved by:
Total	24	6	3	2	1	0	36	<i>[Signature]</i>
Total * 8	192	48	24	16	8	0	288	LT. STRONG #8520
Total personnel assigned to this command.....								36

CLEVELAND DIVISION OF POLICE Daily Duty Assignments

District: FOURTH

Platoon: CSU

Day: THURSDAY



April 15, 2021

Rank	Name	Assignment	Rank	Name	Assignment
LT	CORNACCHIONE 8515	4S60 0800HRS	PARISH	2045	OFFICE 0800HRS
SGT	FREEMAN 9201	4S63 0700HRS	MILLER	2072	IN SERVICE 0800HRS
SGT	SCHNEIDER 9237	4S64 1700HRS			

Car	Rank Name	Rank Name	Car	Rank Name	Rank Name
	<u>0600 HRS</u>			<u>1800 HRS</u>	
4F17	PIPER 1113	TRINH 505	4F36	O.O.S.	O.O.S.
4G13	O.O.S.		4F38	BUZZELLI 588	DOUGLAS 991
	<u>0900 HRS</u>		4F39	O.O.S.	O.O.S.
4G14	LEE 2512		4G37	PAYNE 1751	
4G15	O.O.S.		4G39	ELLENBERGER 1331	

Vacation Days			Furlough Days		
Rank	Name	Rank Name	Rank	Name	Rank Name
					DAVIS 1643 HODGES 206

Rank	Name	Sick/Other	Rank	Name	OTT HRS	Vehicles Out of Service	
						Call#	Reason
				GRECZANIK 1644	-8		

Rank	Working	V-Day	F-Day	Sick	OTT	Other	Totals	Respectfully,
Cmdr/Capt								0
Lt.	1	0	0	0	0	0	1	 SGT. SCHNEIDER # 9237
Sergt.	2	0	0	0	0	0	2	
P.O.	9	0	2	0	1	0	12	Examined and Approved:  LT. CORNACCHIONE # 8515
Total	12	0	2	0	1	0	15	
Total personnel assigned to this command.....								15

Last Name	First Name	Rank	Badge	Payroll	Assigned	Violation	Initiated By	Date of Incident
-----------	------------	------	-------	---------	----------	-----------	--------------	------------------

Piper	Daniel	PO	1113	195664	Third	ULLF - Fail to request supervisor to the scene	Sgt. Eggelme yer	5/17/2016
-------	--------	----	------	--------	-------	---	------------------------	-----------

Date of Receipt	Date of Expiration	Date of Hearing	Disposition
-----------------	--------------------	-----------------	-------------

8/14/2016	5/17/2016	10/20/2016	Dismissed per D.C. Drummond & Lt. Carney (10/20/2016)
-----------	-----------	------------	---

**202100109904 - CDX - 2M - CIVIL DISPUTE - 2M
13617 BEACHWOOD AVE CLEV**
 System Comments

Date/Time	Terminal	Operator	
04/15/21 03:54:34	psct-265	202296	EVENT CREATED - Type: CDX - 2M - CIVIL DISPUTE - 2M, Location: 13617 BEACHWOOD AVE CLEV, Agency: CPD, Group: D4, Beat: 47, Status: P, Priority: 3
04/15/21 03:54:34	psct-265	202296	INITIAL CALL - Call Source: 1234, Caller Name: KIRSTEN, MONIQUE, Caller Phone Number: [REDACTED] Caller Address:
04/15/21 03:54:34	psct-265	202296	EVENT REMARK - CLR STS HER DAUGHTERS EX BOYF OUTSIDE REF TO LEAVE STS ML IS OUTSIDE KNOCKING ON THE PORCH NO KIDS TOGETHER CLR NOW ARGUING W/ ML NOT ANSWERING MY QUESTIONS ATT CB CORR ML WAS KNOCKING ON HER DOOR, HES OUTSIDE ON PORCH NR ON CB'S
04/15/21 03:54:34	ps-cadcom01-v	202296	EVENT REMARK - ** LOI search completed at 04/15/21 03:54:34
04/15/21 03:54:49	psct-265	202296	EVENT REMARK - DIDNT GIVE ME ANY INFO ON ML
04/15/21 03:56:39	psct-273	992242	INITIAL CALL - Call Source: [REDACTED], Caller Name: TYREE 14YR, Caller Phone Number: [REDACTED] Caller Address:
04/15/21 03:56:39	psct-273	992242	EVENT REMARK - Duplicate Event: Location = 13617 BEACHWOOD AVE CLEV, Cross Street 1 = E 136TH ST, Cross Street 2 = E 137TH ST, Type = CDX - CIVIL DISPUTE, Subtype = 2M - 2M, Caller Name = TYREE 14YR, Caller Ph Number = (216) 682-8607, Alarm Level = 0
04/15/21 03:56:39	psct-273	992242	EVENT REMARK - CALLER STATES HIS SISTER BOYFRIEND IS AT THE DOOR AND NOT SUPPOSE TO BE CALLER REFUSE TO PUT HIS MOTHER ON THE PHONE AND STATES HIS SISTER IS NOT HOME
04/15/21 03:56:39	psct-273	992242	EVENT REMARK - End of Duplicate Event data
04/15/21 03:57:26	psct-273	992242	EVENT REMARK - CALLER MOTHER REF TO GET ON THE PHONE
04/15/21 03:57:34	psct-273	992242	EVENT REMARK - BUT IS YELLING IN THE BACK GROUND
04/15/21 03:57:40	psct-273	992242	EVENT UPDATED - Common Event Revision Number: 2, Priority: 2, Priority Changed Time: 04/15/21 03:57:40, HasInformerLoiData: True,
04/15/21 03:57:40	psct-273	992242	EVENT REMARK - ** Event Priority changed from 3 to 2 at: 04/15/21 03:57:40 ** >>> by: DEBRA BREWER on terminal: psct-273
04/15/21 03:58:25	psct-273	992242	EVENT REMARK - BML NAME IS NUT
04/15/21 03:58:41	psct-273	992242	EVENT REMARK - MALE DRIVES SILVER OR GRAY
04/15/21 03:59:48	psct-273	992242	EVENT REMARK - CALLER MOTHER IS AT THE DOOR SPEAKING TO DAUGHTER EX BOYFRIEND
04/15/21 04:00:06	psct-273	992242	EVENT REMARK - MOTHER NAME IS RASHEDA
04/15/21 04:01:01	pspd-289	201542	EVENT REMARK - ATTEMPTED TO DISPATCH TO UNIT
04/15/21 04:01:11	pspd-289	201542	EVENT UPDATED - Total Assigned Units: 1,
04/15/21 04:01:11	pspd-289	201542	EVENT UPDATED - First Unit Dispatched Time: 04/15/21 04:01:11, Primary Employee Id: 2085, Primary Unit Id: 4B37, Status Code: A,
04/15/21 04:01:11	pspd-289	201542	EVENT UPDATED -
04/15/21 04:01:11	pspd-289	201542	UNIT UPDATED - Unit: 4B37, Status: DP, Location: 13617 BEACHWOOD AVE CLEV, Employees: 2085, 716183
04/15/21 04:01:51	\$4B37	2085	EVENT UPDATED - First Unit Enrouted Time: 04/15/21 04:01:51,
04/15/21 04:01:51	\$4B37	2085	UNIT UPDATED - Unit: 4B37, Status: ER, Location: 13617 BEACHWOOD AVE CLEV, Employees: 2085, 716183
04/15/21	\$4B37	2085	EVENT UPDATED - First Unit Arrived Time: 04/15/21 04:11:13,

04:11:13			
04/15/21 04:11:13	\$4B37	2085	UNIT UPDATED - Unit: 4B37, Status: AR, Location: 13617 BEACHWOOD AVE CLEV, Employees: 2085, 716183
04/15/21 04:13:26	pspd-289	201542	EVENT REMARK - M169281
04/15/21 04:14:38	pspd-289	201542	EVENT UPDATED -
04/15/21 04:14:38	ps- cadcom01- v	201542	EVENT REMARK - ** VEH search completed at 04/15/21 04:14:38
04/15/21 04:14:38	pspd-289	201542	ADD SUPPLEMENTAL- Revision Number: 1, Supplemental Type: Vehicle,
04/15/21 04:16:33	pspd-289	201542	EVENT REMARK - REQ ANOTHER ZC
04/15/21 04:16:48	pspd-289	201542	EVENT UPDATED - Total Assigned Units: 2,
04/15/21 04:16:48	pspd-289	201542	UNIT UPDATED - Unit: 4B33, Status: DP, Location: 13617 BEACHWOOD AVE CLEV, Employees: 629
04/15/21 04:16:49	pspd-289	201542	EVENT UPDATED - Total Assigned Units: 3,
04/15/21 04:16:49	pspd-289	201542	UNIT UPDATED - Unit: 4A34, Status: DP, Location: 13617 BEACHWOOD AVE CLEV, Employees: 1276, 1850
04/15/21 04:16:57	\$4B33	629	UNIT UPDATED - Unit: 4B33, Status: ER, Location: 13617 BEACHWOOD AVE CLEV, Employees: 629
04/15/21 04:16:57	\$4A34	1276	UNIT UPDATED - Unit: 4A34, Status: ER, Location: 13617 BEACHWOOD AVE CLEV, Employees: 1276, 1850
04/15/21 04:17:52	pspd-289	201542	EVENT REMARK - HEAVY SET SHORT ML WEARING ALL GREY SWEATS RSN OUT THE HOUSE WHEN POLICE PLLED UP
04/15/21 04:18:01	pspd-289	201542	EVENT REMARK - ML MAY HAVE A HOMICIDE WARRANT
04/15/21 04:18:21	pspd-289	201542	EVENT REMARK - ML WENT NB FROM BEACHWOOD
04/15/21 04:18:29	pspd-289	201542	EVENT REMARK - E137TH/ BEACHWOOD
04/15/21 04:18:32	pspd-289	201542	EVENT UPDATED - Total Assigned Units: 4,
04/15/21 04:18:32	pspd-289	201542	UNIT UPDATED - Unit: 4B31, Status: DP, Location: 13617 BEACHWOOD AVE CLEV, Employees: 938
04/15/21 04:18:34	pspd-289	201542	EVENT UPDATED - Total Assigned Units: 5,
04/15/21 04:18:34	pspd-289	201542	UNIT UPDATED - Unit: 4B38, Status: DP, Location: 13617 BEACHWOOD AVE CLEV, Employees: 194, 202108
04/15/21 04:18:39	pspd-289	201542	EVENT UPDATED - Total Assigned Units: 6,
04/15/21 04:18:39	pspd-289	201542	UNIT UPDATED - Unit: 4A36, Status: DP, Location: 13617 BEACHWOOD AVE CLEV, Employees: 1784
04/15/21 04:18:45	\$4B38	194	UNIT UPDATED - Unit: 4B38, Status: ER, Location: 13617 BEACHWOOD AVE CLEV, Employees: 194, 202108
04/15/21 04:18:46	\$4A34	1276	UNIT UPDATED - Unit: 4A34, Status: AR, Location: 13617 BEACHWOOD AVE CLEV, Employees: 1276, 1850
04/15/21 04:18:47	\$4A34	1276	UNIT UPDATED - Unit: 4A34, Status: AR, Location: 13617 BEACHWOOD AVE CLEV, Employees: 1276, 1850
04/15/21 04:18:48	\$4A34	1276	UNIT UPDATED - Unit: 4A34, Status: AR, Location: 13617 BEACHWOOD AVE CLEV, Employees: 1276, 1850
04/15/21 04:18:51	\$4A36	1784	UNIT UPDATED - Unit: 4A36, Status: AR, Location: 13617 BEACHWOOD AVE CLEV, Employees: 1784
04/15/21 04:18:53	pspd-289	201542	EVENT UPDATED - Total Assigned Units: 7,
04/15/21 04:18:53	pspd-289	201542	UNIT UPDATED - Unit: 4A31, Status: DP, Location: 13617 BEACHWOOD AVE CLEV, Employees: 283, 202070

04/15/21 04:18:58	\$4B31	938	UNIT UPDATED - Unit: 4B31, Status: ER, Location: 13617 BEACHWOOD AVE CLEV, Employees: 938
04/15/21 04:19:03	\$4A31	202070	UNIT UPDATED - Unit: 4A31, Status: ER, Location: 13617 BEACHWOOD AVE CLEV, Employees: 283, 202070
04/15/21 04:19:54	pspd-289	201542	EVENT REMARK - ML FIRST NAME IS INNES LEE
04/15/21 04:19:58	pspd-289	201542	EVENT REMARK - 4S34 ADV
04/15/21 04:21:16	pspd-289	201542	EVENT REMARK - [REDACTED]
04/15/21 04:21:32	pspd-289	201542	EVENT REMARK - Attachment LEE.JPG was added to event
04/15/21 04:21:47	\$4B31	938	UNIT UPDATED - Unit: 4B31, Status: AR, Location: 13617 BEACHWOOD AVE CLEV, Employees: 938
04/15/21 04:21:49	pspd-289	201542	EVENT REMARK - ML RAN NORTH FROM BEACHWOOD, BETWEEN CRANE AND BEACHWOOD
04/15/21 04:22:09	pspd-289	201542	EVENT UPDATED -
04/15/21 04:22:09	ps-cadcom01-v	201542	EVENT REMARK - ** PER search completed at 04/15/21 04:22:09
04/15/21 04:22:09	pspd-289	201542	ADD SUPPLEMENTAL- Revision Number: 1, Supplemental Type: Person,
04/15/21 04:22:21	pspd-289	201542	EVENT REMARK - MKE/WANTED PERSON - CAUTION
04/15/21 04:22:29	pspd-289	201542	EVENT REMARK - EXL/1 FULL EXTRADITION
04/15/21 04:22:43	pspd-289	201542	EVENT REMARK - MIS/PICKUP NATIONWIDE//PRIOR AGG ROB & DRUG POSS ARR MIS/MURDER F1 WARRANT CASE #2020CRA011166 CONTACT DET VOWELL #1815 HOMICIDE UNIT
04/15/21 04:22:58	pspd-289	201542	EVENT REMARK - OFF/HOMICIDE
04/15/21 04:23:07	pspd-289	201542	EVENT REMARK - DOW/20201009
04/15/21 04:24:25	pspd-289	201542	EVENT REMARK - LAST ADDRESS 3677 E 147TH
04/15/21 04:24:53	pspd-289	201542	EVENT REMARK - 4A34-CHECKING BACKYARDS ON CRANE
04/15/21 04:25:29	\$4A31	202070	UNIT UPDATED - Unit: 4A31, Status: AR, Location: 13617 BEACHWOOD AVE CLEV, Employees: 283, 202070
04/15/21 04:26:56	pspd-289	201542	EVENT REMARK - INNES KIRK LEE JR
04/15/21 04:27:08	pspd-289	201542	EVENT REMARK - DOB: 09/12/1995 AGE: 25
04/15/21 04:27:15	pspd-289	201542	EVENT REMARK - SSN: [REDACTED]
04/15/21 04:29:29	pspd-289	201542	EVENT REMARK - 4B37-ML DETAINED
04/15/21 04:34:33	pspd-289	201542	EVENT REMARK - 1 ML UNDER
04/15/21 04:38:51	pspd-289	201542	EVENT REMARK - ML MAY BE STAYING IN AREA OF E 131ST/ CAINE
04/15/21 04:39:05	pspd-289	201542	EVENT REMARK - ***GETTING INFO FOR
04/15/21 04:39:33	pspd-289	201542	EVENT REMARK - 4S34 REACHING OUT TO TASKFORCE
04/15/21 04:39:52	pspd-289	201542	EVENT REMARK - ALL CARS DO NOT APPROACH,
04/15/21 04:40:07	pspd-289	201542	EVENT REMARK - NO ADDRESS, 4S34 OK FOR INFO
04/15/21 04:41:00	pspd-289	201542	EVENT REMARK - REAACH OUT TO GIU OR TASKFORCE,
04/15/21 04:42:25	pspd-289	201542	EVENT REMARK - CD DUSEK ADV
04/15/21 04:42:36	pspd-289	201542	EVENT REMARK - CD DUSEK REACHING OUT TO HOMICIDE

04/15/21 04:43:05	\$4A34	1276	EVENT REMARK - Tracking device 0003714B/MDT/Default System cleared. Tracking device 0003714B/MDT/Default System set. New equipment list for Unit [4A34] :
04/15/21 04:43:05	\$4A34	1276	UNIT UPDATED - Unit: 4A34, Status: DC, Location: 13617 BEACHWOOD AVE CLEV, Employees: 1276, 1850
04/15/21 04:43:06	\$4A34	1276	UNIT UPDATED - Unit: 4A34, Status: DC, Location: 13617 BEACHWOOD AVE CLEV, Employees: 1276, 1850
04/15/21 04:43:07	\$4A34	1276	UNIT UPDATED - Unit: 4A34, Status: UC, Location: 13617 BEACHWOOD AVE CLEV, Employees: 1276, 1850
04/15/21 04:45:15	pspd-300	994496	EVENT REMARK - ** LOI information for Event # 202100109904 was viewed at: 04/15/21 04:45:15 ** >>> by: STEVEN DUSEK on terminal: pspd-300
04/15/21 04:46:39	pspd-289	201542	EVENT REMARK - ADV GARFIELD
04/15/21 04:47:09	\$4A34	1276	EVENT UPDATED - Total Assigned Units: 6,
04/15/21 04:47:09	\$4A34	1276	EVENT REMARK - assisted wcs3
04/15/21 04:47:09	\$4A34	1276	DISPOSITION ASSIGNED - ASST
04/15/21 04:47:09	\$4A34	1276	UNIT UPDATED - Unit: 4A34, Status: AM, Location: , Employees: 1276, 1850
04/15/21 04:47:47	pspd-289	201542	EVENT REMARK - NO VEH LISTED UNDER ML NAME
04/15/21 04:49:02	\$4A36	1784	EVENT UPDATED - Total Assigned Units: 5,
04/15/21 04:49:02	\$4A36	1784	EVENT REMARK - ASSISTED OTHER UNIT TO HANDLE.. WCS3
04/15/21 04:49:02	\$4A36	1784	DISPOSITION ASSIGNED - ASST
04/15/21 04:49:02	\$4A36	1784	UNIT UPDATED - Unit: 4A36, Status: AM, Location: , Employees: 1784
04/15/21 04:50:18	\$4B38	194	UNIT UPDATED - Unit: 4B38, Status: AR, Location: 13617 BEACHWOOD AVE CLEV, Employees: 194, 202108
04/15/21 04:52:35	pspd-289	201542	EVENT REMARK - 4S34 UNABLE TO GET IN CONTACT ITH ANYONE FROM TASKFORCE
04/15/21 04:52:44	pspd-289	201542	EVENT REMARK - NO VEH IN MK NAME OR FATHER NAME
04/15/21 04:53:50	pspd-289	201542	EVENT REMARK - GARFIELD PD 216-475-1234
04/15/21 05:04:39	\$4B31	938	EVENT UPDATED - Total Assigned Units: 4,
04/15/21 05:04:39	\$4B31	938	DISPOSITION ASSIGNED - ASST
04/15/21 05:04:39	\$4B31	938	UNIT UPDATED - Unit: 4B31, Status: AM, Location: , Employees: 938
04/15/21 05:04:40	\$4B31	938	EVENT REMARK - assisted b37
04/15/21 05:05:36	\$4B38	194	EVENT UPDATED - Total Assigned Units: 3,
04/15/21 05:05:36	\$4B38	194	EVENT REMARK - ASST 4B37
04/15/21 05:05:36	\$4B38	194	DISPOSITION ASSIGNED - ASST
04/15/21 05:05:36	\$4B38	194	UNIT UPDATED - Unit: 4B38, Status: AM, Location: , Employees: 194, 202108
04/15/21 05:06:01	\$4A31	202070	EVENT UPDATED - Total Assigned Units: 2,
04/15/21 05:06:01	\$4A31	202070	EVENT REMARK - ASST B37 WCS3
04/15/21 05:06:01	\$4A31	202070	DISPOSITION ASSIGNED - ASST
04/15/21 05:06:01	\$4A31	202070	UNIT UPDATED - Unit: 4A31, Status: AM, Location: , Employees: 283, 202070
04/15/21 05:12:16	pspd-288	202564	EVENT UPDATED - Total Assigned Units: 3,

04/15/21 05:12:16	pspd-288	202564	UNIT UPDATED - Unit: 4S34, Status: DP, Location: 13617 BEACHWOOD AVE CLEV, Employees: 993666
04/15/21 05:12:18	pspd-288	202564	UNIT UPDATED - Unit: 4S34, Status: AR, Location: 13617 BEACHWOOD AVE CLEV, Employees: 993666
04/15/21 05:12:58	pspd-288	202564	EVENT REMARK - 4S34 -- GOT A HOLD OF THE TASK FORCE -- ENRT
04/15/21 05:12:59	pspd-288	202564	UNIT UPDATED - Unit: 4S34, Status: EC, Location: 13617 BEACHWOOD AVE CLEV, Employees: 993666
04/15/21 05:21:52	pspd-300	994496	EVENT REMARK - ** LOI information for Event # 202100109904 was viewed at: 04/15/21 05:21:52 ** >>>> by: STEVEN DUSEK on terminal: pspd-300
04/15/21 05:31:30	\$4S34	993666	UNIT UPDATED - Unit: 4S34, Status: DC, Location: 13617 BEACHWOOD AVE CLEV, Employees: 993666
04/15/21 05:31:31	\$4S34	993666	EVENT REMARK - Tracking device 00037134/MDT/Default System cleared. Tracking device 00037134/MDT/Default System set. New equipment list for Unit [4S34] :
04/15/21 05:31:31	\$4S34	993666	UNIT UPDATED - Unit: 4S34, Status: DC, Location: 13617 BEACHWOOD AVE CLEV, Employees: 993666
04/15/21 05:31:32	\$4S34	993666	UNIT UPDATED - Unit: 4S34, Status: UC, Location: 13617 BEACHWOOD AVE CLEV, Employees: 993666
04/15/21 05:31:48	\$4S34	993666	UNIT UPDATED - Unit: 4S34, Status: AR, Location: 13617 BEACHWOOD AVE CLEV, Employees: 993666
04/15/21 06:03:52	\$4B33	629	EVENT UPDATED - Total Assigned Units: 2,
04/15/21 06:03:52	\$4B33	629	DISPOSITION ASSIGNED - ASST
04/15/21 06:03:52	\$4B33	629	UNIT UPDATED - Unit: 4B33, Status: AM, Location: , Employees: 629
04/15/21 06:04:36	\$4S34	993666	EVENT UPDATED - Total Assigned Units: 1,
04/15/21 06:04:36	\$4S34	993666	EVENT REMARK - male arrested wcs 2
04/15/21 06:04:36	\$4S34	993666	DISPOSITION ASSIGNED - INFO
04/15/21 06:04:36	\$4S34	993666	UNIT UPDATED - Unit: 4S34, Status: AM, Location: , Employees: 993666
04/15/21 06:13:41	pspd-289	201542	EVENT REMARK - ER TO CCSO
04/15/21 06:13:50	pspd-289	201542	EVENT REMARK - ER TO CCS
04/15/21 06:13:50	pspd-289	201542	UNIT UPDATED - Unit: 4B37, Status: DW, Location: 13617 BEACHWOOD AVE CLEV, Employees: 2085, 716183
04/15/21 06:14:02	pspd-289	201542	EVENT REMARK - ER TO CCSO
04/15/21 06:14:02	pspd-289	201542	UNIT UPDATED - Unit: 4B37, Status: DW, Location: 13617 BEACHWOOD AVE CLEV, Employees: 2085, 716183
04/15/21 06:31:12	pspd-288	994895	EVENT REMARK - S34 - SUSP ADV THAT SUSP WILL RETURN TO FINISH THE JOB / CALLER ADV TO CALL CPD WHEN ML IS SCENE // ML IS SUPPOSED TO BE IN THE AREA WAITING FOR THE DAUGHTER TO RETURN
04/15/21 07:05:15	pspd-288	994895	EVENT REMARK - B37 - COMP AT CCSO ER D4 / REQ NO LUNCH & OT C/W M/T/E & FORM 1 // S34 OK
04/15/21 07:05:19	pspd-288	994895	EVENT REMARK - Delete Dispatch Warning
04/15/21 07:05:19	pspd-288	994895	UNIT UPDATED - Unit: 4B37, Status: DW, Location: 13617 BEACHWOOD AVE CLEV, Employees: 2085, 716183
04/15/21 07:16:31	\$4B37	2085	EVENT UPDATED - Total Assigned Units: 0,
04/15/21 07:16:31	\$4B37	2085	EVENT CLOSED -
04/15/21 07:16:31	\$4B37	2085	EVENT UPDATED - Closing Employee Id: 2085, Closing Terminal: \$4B37, Closing Time: 04/15/21 07:16:31, Is Open: False,

04/15/21 07:16:31	\$4B37	2085	EVENT REMARK - IR (FOSTER) 1 MALE UNDER VSDL DRUG TRAFICKING CRIMINAL TOOLS / VEH TOWED / WCS 2
04/15/21 07:16:31	\$4B37	2085	DISPOSITION ASSIGNED - INFO
04/15/21 07:16:31	\$4B37	2085	DISPOSITION ASSIGNED - REPT
04/15/21 07:16:31	\$4B37	2085	DISPOSITION ASSIGNED - ARR
04/15/21 07:16:31	\$4B37	2085	UNIT UPDATED - Unit: 4B37, Status: AM, Location: , Employees: 2085, 716183

**202100110000 - TRUN - 2M - TROUBLE - UNKNOWN CAUSE - 2M
13617 BEACHWOOD AVE CLEV**

 System Comments

Date/Time	Terminal	Operator	
04/15/21 08:04:15	pspd-288	994895	EVENT CREATED - Type: TRUN - 2M - TROUBLE - UNKNOWN CAUSE - 2M, Location: 13617 BEACHWOOD AVE CLEV, Agency: CPD, Group: D4, Beat: 47, Status: P, Priority: 2
04/15/21 08:04:15	pspd-288	994895	INITIAL CALL - Call Source: 1234, Caller Name: S34, Caller Phone Number: , Caller Address:
04/15/21 08:04:15	pspd-288	994895	EVENT REMARK - FM ON THE LINE SUSP ON SCN
04/15/21 08:04:15	ps- cadcom01- v	994895	EVENT REMARK - ** LOI search completed at 04/15/21 08:04:15
04/15/21 08:04:37	pspd-288	994895	EVENT UPDATED - Total Assigned Units: 1,
04/15/21 08:04:37	pspd-288	994895	EVENT UPDATED - First Unit Dispatched Time: 04/15/21 08:04:37, Primary Employee Id: 483, Primary Unit Id: 4A18, Status Code: A,
04/15/21 08:04:37	pspd-288	994895	EVENT UPDATED -
04/15/21 08:04:37	pspd-288	994895	UNIT UPDATED - Unit: 4A18, Status: DP, Location: 13617 BEACHWOOD AVE CLEV, Employees: 483
04/15/21 08:04:39	pspd-288	994895	EVENT UPDATED - Total Assigned Units: 2,
04/15/21 08:04:39	pspd-288	994895	UNIT UPDATED - Unit: 4F17, Status: DP, Location: 13617 BEACHWOOD AVE CLEV, Employees: 505, 994366
04/15/21 08:04:46	\$4F17	994366	EVENT UPDATED - First Unit Enrouted Time: 04/15/21 08:04:46,
04/15/21 08:04:46	\$4F17	994366	UNIT UPDATED - Unit: 4F17, Status: ER, Location: 13617 BEACHWOOD AVE CLEV, Employees: 505, 994366
04/15/21 08:04:53	\$4A18	483	UNIT UPDATED - Unit: 4A18, Status: ER, Location: 13617 BEACHWOOD AVE CLEV, Employees: 483
04/15/21 08:05:31	pspd-288	994895	EVENT REMARK - ML ON FRNT PORCH W/ GRAY HOODIE COVERED UP / NOT SURE IF HE HAS A WPN
04/15/21 08:05:53	pspd-288	994895	EVENT UPDATED - Total Assigned Units: 3,
04/15/21 08:05:53	pspd-288	994895	UNIT UPDATED - Unit: 4A16, Status: DP, Location: 13617 BEACHWOOD AVE CLEV, Employees: 199138, 706181
04/15/21 08:06:02	pspd-288	994895	EVENT REMARK - S34 - REQ TASK FORCE
04/15/21 08:06:20	pspd-288	994895	EVENT REMARK XXXXXXXXXX
04/15/21 08:06:32	pspd-288	994895	EVENT REMARK - Attachment INNES LEE.JPG was added to event
04/15/21 08:07:04	pspd-288	994895	EVENT REMARK - B37 - HSE IS ON NORTH SIDE OF BEACHWOOD / ML WENT NB WHEN HE RAN EARLIER
04/15/21 08:07:27	\$4A16	199138	UNIT UPDATED - Unit: 4A16, Status: ER, Location: 13617 BEACHWOOD AVE CLEV, Employees: 199138, 706181
04/15/21 08:07:57	pspd-288	994895	EVENT REMARK - CD HAILES ADV
04/15/21 08:08:45	pspd-288	994895	EVENT REMARK - ML LEAVING OFF THE PORCH
04/15/21 08:09:43	pspd-288	994895	EVENT REMARK - ML ON FOOT TWRDS 136TH/BEACHWOOD
04/15/21 08:10:12	pspd-288	994895	EVENT REMARK - POSS K9 / TO HAVE THEM ROLLING THIS WAY IN CASE HE TAKES OFF
04/15/21 08:11:07	pspd-288	994895	UNIT UPDATED - Unit: 4F17, Status: AR, Location: 13617 BEACHWOOD AVE CLEV, Employees: 505, 994366
04/15/21 08:11:08	pspd-288	994895	EVENT UPDATED - First Unit Arrived Time: 04/15/21 08:11:07,
04/15/21 08:11:09	\$4F17	994366	UNIT UPDATED - Unit: 4F17, Status: AR, Location: 13617 BEACHWOOD AVE CLEV, Employees: 505, 994366

04/15/21 08:11:09	\$4F17	994366	UNIT UPDATED - Unit: 4F17, Status: AR, Location: 13617 BEACHWOOD AVE CLEV, Employees: 505, 994366
04/15/21 08:11:10	\$4F17	994366	UNIT UPDATED - Unit: 4F17, Status: AR, Location: 13617 BEACHWOOD AVE CLEV, Employees: 505, 994366
04/15/21 08:11:10	\$4F17	994366	UNIT UPDATED - Unit: 4F17, Status: AR, Location: 13617 BEACHWOOD AVE CLEV, Employees: 505, 994366
04/15/21 08:12:28	pspd-288	994895	UNIT UPDATED - Unit: 4A18, Status: AR, Location: 13617 BEACHWOOD AVE CLEV, Employees: 483
04/15/21 08:12:31	\$4A18	483	UNIT UPDATED - Unit: 4A18, Status: AR, Location: 13617 BEACHWOOD AVE CLEV, Employees: 483
04/15/21 08:12:44	pspd-288	994895	EVENT REMARK - S34 - LS WB ON 136
04/15/21 08:12:49	pspd-288	994895	EVENT REMARK - LIVES ON 134TH
04/15/21 08:13:23	pspd-288	994895	EVENT REMARK - PER OLN 3677 E 147TH
04/15/21 08:14:34	pspd-288	994895	EVENT REMARK - PER LAST NIGHTS CAD // POSS PLT M169281
04/15/21 08:14:56	pspd-288	994895	EVENT REMARK - EXL/1 FULL EXTRADITION
04/15/21 08:15:05	pspd-288	994895	EVENT REMARK - S34 - CK HSES ON E 134TH
04/15/21 08:17:59	pspd-288	994895	EVENT REMARK - S34 - SPEAKING W/ CALLER GAVE LOC 4281 / 4286 E 134
04/15/21 08:18:12	pspd-288	994895	EVENT REMARK - 1 IS A BRN HSE // OR A BLU HSE // UNKWN IF VAC
04/15/21 08:19:47	pspd-288	994895	EVENT UPDATED - Total Assigned Units: 4,
04/15/21 08:19:47	pspd-288	994895	UNIT UPDATED - Unit: 4I77, Status: DP, Location: 13617 BEACHWOOD AVE CLEV, Employees:
04/15/21 08:20:41	pspd-288	994895	EVENT REMARK - I77 - UC GRY IMPALA
04/15/21 08:21:43	pspd-288	994895	EVENT REMARK - 126TH/BEACHWOOD - GRY HOODIE W/ C ON IT // NOT SUSP /MENTALLY DISABLED ML
04/15/21 08:22:38	pspd-288	994895	EVENT REMARK - GARFIELD ADV
04/15/21 08:22:47	pspd-288	994895	EVENT REMARK - CK'ING 4281 // NO 4286
04/15/21 08:22:55	pspd-288	994895	EVENT REMARK - S34 - BRN OR BLU HSE
04/15/21 08:23:15	pspd-288	994895	EVENT REMARK - CK'ING 136TH
04/15/21 08:23:42	pspd-288	994895	EVENT REMARK - ML RUNNING EB JUMPING FENCE
04/15/21 08:23:54	pspd-288	994895	EVENT REMARK - A16 SHOTS FIRED
04/15/21 08:24:03	pspd-288	994895	EVENT UPDATED - Total Assigned Units: 5,
04/15/21 08:24:03	pspd-288	994895	UNIT UPDATED - Unit: 4S13, Status: DP, Location: 13617 BEACHWOOD AVE CLEV, Employees:
04/15/21 08:24:06	pspd-288	994895	EVENT REMARK - SHOTS FIRED ML DOWN
04/15/21 08:24:19	pspd-288	994895	EVENT REMARK - 281 E 134
04/15/21 08:24:33	pspd-288	994895	EVENT REMARK - S13 ALL LATE CARS HEADED THIS WAY
04/15/21 08:24:40	pspd-300	993187	EVENT REMARK - EMS NOTIFIED
04/15/21 08:24:41	pspd-288	994895	EVENT REMARK - 4281 E 134TH
04/15/21 08:25:16	pspd-288	994895	EVENT REMARK - B11
04/15/21 08:25:25	pspd-288	994895	EVENT REMARK - D17

04/15/21 08:25:26	pspd-288	994895	EVENT REMARK - B15
04/15/21 08:25:31	pspd-288	994895	EVENT REMARK - KEEPIGN THE AIR CLEAR
04/15/21 08:25:34	pspd-288	994895	EVENT UPDATED - Total Assigned Units: 6,
04/15/21 08:25:34	pspd-288	994895	UNIT UPDATED - Unit: 4B11, Status: DP, Location: 13617 BEACHWOOD AVE CLEV, Employees:
04/15/21 08:25:49	\$4B11	202104	EVENT REMARK - New equipment list for Unit [4B11] : Device 00037056/MDT/Default System added for employee 202104. Tracking device 00037056/MDT/Default System set. Tracking device 00037056/MDT/Default System set for employee 202104.
04/15/21 08:25:49	\$4B11	202104	UNIT UPDATED - Unit: 4B11, Status: UE, Location: 13617 BEACHWOOD AVE CLEV, Employees: 202104
04/15/21 08:25:50	\$4B11	202104	UNIT UPDATED - Unit: 4B11, Status: UC, Location: 13617 BEACHWOOD AVE CLEV, Employees: 202104
04/15/21 08:25:51	\$4B11	202104	UNIT UPDATED - Unit: 4B11, Status: AM, Location: 13617 BEACHWOOD AVE CLEV, Employees: 202104
04/15/21 08:25:52	\$4B11	202104	UNIT UPDATED - Unit: 4B11, Status: DC, Location: 13617 BEACHWOOD AVE CLEV, Employees: 202104
04/15/21 08:25:53	\$4B11	202104	UNIT UPDATED - Unit: 4B11, Status: DC, Location: 13617 BEACHWOOD AVE CLEV, Employees: 202104
04/15/21 08:25:54	\$4B11	202104	UNIT UPDATED - Unit: 4B11, Status: DC, Location: 13617 BEACHWOOD AVE CLEV, Employees: 202104
04/15/21 08:26:03	\$4B11	202104	UNIT UPDATED - Unit: 4B11, Status: ER, Location: 13617 BEACHWOOD AVE CLEV, Employees: 202104
04/15/21 08:26:10	pspd-288	994895	EVENT UPDATED - Total Assigned Units: 7,
04/15/21 08:26:10	pspd-288	994895	UNIT UPDATED - Unit: 4B15, Status: DP, Location: 13617 BEACHWOOD AVE CLEV, Employees:
04/15/21 08:26:11	pspd-288	994895	EVENT UPDATED - Total Assigned Units: 8,
04/15/21 08:26:11	pspd-288	994895	UNIT UPDATED - Unit: 4D17, Status: DP, Location: 13617 BEACHWOOD AVE CLEV, Employees:
04/15/21 08:26:38	pspd-288	994895	EVENT REMARK - CHEST COMPRESSIONS STARTED
04/15/21 08:26:45	\$4D17	202059	EVENT REMARK - New equipment list for Unit [4D17] : Device 0003713D/MDT/Default System added for employee 202059. Tracking device 0003713D/MDT/Default System set. Tracking device 0003713D/MDT/Default System set for employee 202059.
04/15/21 08:26:45	\$4D17	202059	UNIT UPDATED - Unit: 4D17, Status: UE, Location: 13617 BEACHWOOD AVE CLEV, Employees: 202059
04/15/21 08:26:46	\$4D17	202059	UNIT UPDATED - Unit: 4D17, Status: UC, Location: 13617 BEACHWOOD AVE CLEV, Employees: 202059
04/15/21 08:26:47	\$4D17	202059	UNIT UPDATED - Unit: 4D17, Status: AM, Location: 13617 BEACHWOOD AVE CLEV, Employees: 202059
04/15/21 08:26:48	\$4D17	202059	UNIT UPDATED - Unit: 4D17, Status: DC, Location: 13617 BEACHWOOD AVE CLEV, Employees: 202059
04/15/21 08:26:49	\$4D17	202059	UNIT UPDATED - Unit: 4D17, Status: DC, Location: 13617 BEACHWOOD AVE CLEV, Employees: 202059
04/15/21 08:26:50	\$4D17	202059	UNIT UPDATED - Unit: 4D17, Status: DC, Location: 13617 BEACHWOOD AVE CLEV, Employees: 202059
04/15/21 08:26:54	pspd-289	198832	EVENT REMARK - MED 11 ENR
04/15/21 08:27:00	pspd-289	198832	EVENT REMARK - EMS NO ETA -
04/15/21 08:27:06	pspd-289	198832	EVENT REMARK - ADV OF UPDATES
04/15/21 08:27:09	pspd-288	994895	EVENT REMARK - BACKYARD OF 4281 134

04/15/21 08:27:30	pspd-288	994895	EVENT REMARK - 4281 E 134
04/15/21 08:27:30	pspd-288	994895	UNIT UPDATED - Unit: 4A18, Status: DW, Location: 13617 BEACHWOOD AVE CLEV, Employees: 483
04/15/21 08:27:54	pspd-289	198832	EVENT REMARK - EMS ADV OF LOCATION
04/15/21 08:28:03	pspd-289	198832	EVENT REMARK - NOTIF HOMICIDE NEED SHOOTING TEAM ON SCN
04/15/21 08:28:05	pspd-288	994895	EVENT REMARK - S70 . REQ HOMICIDE NEED SHOOTING TEAM
04/15/21 08:28:12	pspd-289	198832	EVENT REMARK - CD HAILES COPIES
04/15/21 08:28:31	pspd-288	994895	EVENT REMARK - BLOCK 134 / BEACHWOOD & CAINE
04/15/21 08:28:34	pspd-289	198832	EVENT REMARK - BLOCK 134/BEACHWOOD/CAINE
04/15/21 08:28:45	\$4B15	358	EVENT REMARK - Device 0425/GPS Device/Default System added. New equipment list for Unit [4B15] : Device 00037157/MDT/Default System added for employee 358. Tracking device 00037157/MDT/Default System set. Tracking device 00037157/MDT/Default System set for employee 358.
04/15/21 08:28:45	\$4B15	358	UNIT UPDATED - Unit: 4B15, Status: DC, Location: 13617 BEACHWOOD AVE CLEV, Employees:
04/15/21 08:28:46	\$4B15	358	UNIT UPDATED - Unit: 4B15, Status: UE, Location: 13617 BEACHWOOD AVE CLEV, Employees: 358
04/15/21 08:28:47	\$4B15	358	UNIT UPDATED - Unit: 4B15, Status: UC, Location: 13617 BEACHWOOD AVE CLEV, Employees: 358
04/15/21 08:28:48	\$4B15	358	UNIT UPDATED - Unit: 4B15, Status: AM, Location: 13617 BEACHWOOD AVE CLEV, Employees: 358
04/15/21 08:28:48	pspd-289	198832	EVENT REMARK - CONTACT D5 ANED D5 AND D3 FOR CARS
04/15/21 08:28:49	\$4B15	358	UNIT UPDATED - Unit: 4B15, Status: DC, Location: 13617 BEACHWOOD AVE CLEV, Employees: 358
04/15/21 08:28:50	\$4B15	358	UNIT UPDATED - Unit: 4B15, Status: DC, Location: 13617 BEACHWOOD AVE CLEV, Employees: 358
04/15/21 08:28:51	\$4B15	358	UNIT UPDATED - Unit: 4B15, Status: DC, Location: 13617 BEACHWOOD AVE CLEV, Employees: 358
04/15/21 08:28:53	pspd-288	994895	EVENT REMARK - S13 - REQ D5 & D3 TO GET 2 CARS EACH
04/15/21 08:29:17	pspd-289	198832	EVENT REMARK - TO ASSIST WITH BOARD
04/15/21 08:29:18	pspd-288	994895	EVENT REMARK - S50 - REQ 1 CAR FROM D3/D5
04/15/21 08:29:50	pspd-289	198832	EVENT REMARK - D1 AND D2 ADV
04/15/21 08:30:06	pspd-288	994895	EVENT REMARK - S13 - REQ ANY CSU CAR IF SHORT ON CARS
04/15/21 08:30:38	pspd-289	198832	EVENT REMARK - REQ CD FOR PARTNER
04/15/21 08:31:04	pspd-288	994895	EVENT REMARK - S13 - WILL BE WORKING OFF TAC SHORTLY
04/15/21 08:31:12	pspd-289	198832	EVENT REMARK - 26 BLOCKING 134/CAINE
04/15/21 08:31:20	pspd-288	994895	EVENT UPDATED - Total Assigned Units: 9,
04/15/21 08:31:20	pspd-288	994895	UNIT UPDATED - Unit: 4S14, Status: DP, Location: 13617 BEACHWOOD AVE CLEV, Employees:
04/15/21 08:31:21	pspd-289	198832	EVENT REMARK - S14 ON SCN
04/15/21 08:31:21	pspd-288	994895	UNIT UPDATED - Unit: 4S14, Status: AR, Location: 13617 BEACHWOOD AVE CLEV, Employees:
04/15/21 08:31:23	pspd-289	198832	EVENT REMARK - S63 ON SCN
04/15/21 08:31:51	pspd-288	994895	EVENT UPDATED - Total Assigned Units: 10,

04/15/21 08:31:51	pspd-288	994895	UNIT UPDATED - Unit: 4S63, Status: DP, Location: 13617 BEACHWOOD AVE CLEV, Employees:
04/15/21 08:32:36	\$4D17	202059	UNIT UPDATED - Unit: 4D17, Status: ER, Location: 13617 BEACHWOOD AVE CLEV, Employees: 202059
04/15/21 08:32:38	\$4D17	202059	UNIT UPDATED - Unit: 4D17, Status: AR, Location: 13617 BEACHWOOD AVE CLEV, Employees: 202059
04/15/21 08:32:53	pspd-288	994895	UNIT UPDATED - Unit: 4I77, Status: AR, Location: 13617 BEACHWOOD AVE CLEV, Employees:
04/15/21 08:32:56	pspd-288	994895	UNIT UPDATED - Unit: 4S13, Status: AR, Location: 13617 BEACHWOOD AVE CLEV, Employees:
04/15/21 08:33:37	pspd-288	994895	EVENT UPDATED - Total Assigned Units: 11,
04/15/21 08:33:37	pspd-288	994895	UNIT UPDATED - Unit: 4C37, Status: DP, Location: 13617 BEACHWOOD AVE CLEV, Employees: 202035
04/15/21 08:33:51	pspd-288	994895	EVENT UPDATED - Total Assigned Units: 12,
04/15/21 08:33:51	pspd-288	994895	UNIT UPDATED - Unit: 4C16, Status: DP, Location: 13617 BEACHWOOD AVE CLEV, Employees:
04/15/21 08:34:08	pspd-288	994895	EVENT REMARK - 134/CAINE
04/15/21 08:34:08	pspd-288	994895	UNIT UPDATED - Unit: 4C16, Status: DW, Location: 13617 BEACHWOOD AVE CLEV, Employees:
04/15/21 08:34:23	pspd-289	198832	UNIT UPDATED - Unit: 4C37, Status: AR, Location: 13617 BEACHWOOD AVE CLEV, Employees: 202035
04/15/21 08:34:29	pspd-289	198832	UNIT UPDATED - Unit: 4C16, Status: AR, Location: 13617 BEACHWOOD AVE CLEV, Employees:
04/15/21 08:34:42	pspd-288	994895	EVENT UPDATED - Total Assigned Units: 13,
04/15/21 08:34:42	pspd-288	994895	UNIT UPDATED - Unit: 4B17, Status: DP, Location: 13617 BEACHWOOD AVE CLEV, Employees:
04/15/21 08:34:46	pspd-288	994895	UNIT UPDATED - Unit: 4S63, Status: AR, Location: 13617 BEACHWOOD AVE CLEV, Employees:
04/15/21 08:35:30	pspd-300	993187	EVENT REMARK - SAFETY DIRECTOR NOTIFIED
04/15/21 08:35:53	pspd-288	994895	EVENT UPDATED - Total Assigned Units: 14,
04/15/21 08:35:53	pspd-288	994895	UNIT UPDATED - Unit: 4D11, Status: DP, Location: 13617 BEACHWOOD AVE CLEV, Employees:
04/15/21 08:38:03	pspd-288	994895	EVENT UPDATED - Total Assigned Units: 15,
04/15/21 08:38:03	pspd-288	994895	UNIT UPDATED - Unit: 4S12, Status: DP, Location: 13617 BEACHWOOD AVE CLEV, Employees: 993354
04/15/21 08:38:31	pspd-300	993187	EVENT REMARK - GIU/SGT PUTNAM THEY CAN ASSIST IF NEEDED
04/15/21 08:38:41	pspd-289	198832	EVENT UPDATED - Total Assigned Units: 16,
04/15/21 08:38:41	pspd-289	198832	UNIT UPDATED - Unit: 8836, Status: DP, Location: 13617 BEACHWOOD AVE CLEV, Employees:
04/15/21 08:38:42	pspd-289	198832	UNIT UPDATED - Unit: 8836, Status: AR, Location: 13617 BEACHWOOD AVE CLEV, Employees:
04/15/21 08:38:46	pspd-289	198832	EVENT REMARK - 8836 ON SCN
04/15/21 08:38:51	\$4S12	993354	UNIT UPDATED - Unit: 4S12, Status: AR, Location: 13617 BEACHWOOD AVE CLEV, Employees: 993354
04/15/21 08:40:15	pspd-289	198832	EVENT UPDATED - Total Assigned Units: 17,
04/15/21 08:40:15	pspd-289	198832	UNIT UPDATED - Unit: 4S70, Status: DP, Location: 13617 BEACHWOOD AVE CLEV, Employees:
04/15/21 08:40:16	pspd-289	198832	UNIT UPDATED - Unit: 4S70, Status: AR, Location: 13617 BEACHWOOD AVE CLEV, Employees:
04/15/21 08:42:15	\$4B17	825187	EVENT REMARK - Device 0436/GPS Device/Default System added. New equipment list for Unit [4B17] : Device 0003713C/MDT/Default System added for employee 825187. Tracking device 0003713C/MDT/Default System set. Tracking device 0003713C/MDT/Default System set for employee 825187.

04/15/21 08:42:15	\$4B17	825187	UNIT UPDATED - Unit: 4B17, Status: DC, Location: 13617 BEACHWOOD AVE CLEV, Employees: 825187
04/15/21 08:42:16	\$4B17	825187	UNIT UPDATED - Unit: 4B17, Status: UE, Location: 13617 BEACHWOOD AVE CLEV, Employees: 825187
04/15/21 08:42:17	\$4B17	825187	UNIT UPDATED - Unit: 4B17, Status: UC, Location: 13617 BEACHWOOD AVE CLEV, Employees: 825187
04/15/21 08:42:18	\$4B17	825187	UNIT UPDATED - Unit: 4B17, Status: AM, Location: 13617 BEACHWOOD AVE CLEV, Employees: 825187
04/15/21 08:42:19	\$4B17	825187	UNIT UPDATED - Unit: 4B17, Status: DC, Location: 13617 BEACHWOOD AVE CLEV, Employees: 825187
04/15/21 08:42:20	\$4B17	825187	UNIT UPDATED - Unit: 4B17, Status: DC, Location: 13617 BEACHWOOD AVE CLEV, Employees: 825187
04/15/21 08:42:21	\$4B17	825187	UNIT UPDATED - Unit: 4B17, Status: DC, Location: 13617 BEACHWOOD AVE CLEV, Employees: 825187
04/15/21 08:44:32	pspd-288	994895	EVENT UPDATED - Total Assigned Units: 18,
04/15/21 08:44:32	pspd-288	994895	UNIT UPDATED - Unit: 4D18, Status: DP, Location: 13617 BEACHWOOD AVE CLEV, Employees: 994895
04/15/21 08:45:38	pspd-289	198832	EVENT REMARK - 4A18 PRIMARY
04/15/21 08:45:51	pspd-300	993187	EVENT REMARK - HOMICIDE NOTIFIED AND RESPONDING
04/15/21 08:45:53	\$4D11	990964	EVENT REMARK - New equipment list for Unit [4D11] : Device 0003713A/MDT/Default System added for employee 990964. Tracking device 0003713A/MDT/Default System set. Tracking device 0003713A/MDT/Default System set for employee 990964.
04/15/21 08:45:53	\$4D11	990964	UNIT UPDATED - Unit: 4D11, Status: UE, Location: 13617 BEACHWOOD AVE CLEV, Employees: 990964
04/15/21 08:45:54	\$4D11	990964	UNIT UPDATED - Unit: 4D11, Status: UC, Location: 13617 BEACHWOOD AVE CLEV, Employees: 990964
04/15/21 08:45:55	\$4D11	990964	UNIT UPDATED - Unit: 4D11, Status: AM, Location: 13617 BEACHWOOD AVE CLEV, Employees: 990964
04/15/21 08:45:56	\$4D11	990964	UNIT UPDATED - Unit: 4D11, Status: DC, Location: 13617 BEACHWOOD AVE CLEV, Employees: 990964
04/15/21 08:45:57	\$4D11	990964	UNIT UPDATED - Unit: 4D11, Status: DC, Location: 13617 BEACHWOOD AVE CLEV, Employees: 990964
04/15/21 08:45:58	\$4D11	990964	UNIT UPDATED - Unit: 4D11, Status: DC, Location: 13617 BEACHWOOD AVE CLEV, Employees: 990964
04/15/21 08:46:45	pspd-289	198832	EVENT REMARK - 4S14 -- KEEPING 4A18 HERE-4B17 HERE 4B17 4C16 AND 4B15 FOR NOW- NO OTHER CARS NEEDED AT THIS TIME
04/15/21 08:46:46	pspd-289	198832	UNIT UPDATED - Unit: 4S14, Status: EC, Location: 13617 BEACHWOOD AVE CLEV, Employees: 198832
04/15/21 08:46:56	pspd-289	198832	EVENT REMARK - AND 4A16
04/15/21 08:47:18	pspd-300	993187	EVENT REMARK - SIU NOTIFIED AND RESPONDING
04/15/21 08:48:12	\$4D11	990964	UNIT UPDATED - Unit: 4D11, Status: ER, Location: 13617 BEACHWOOD AVE CLEV, Employees: 990964
04/15/21 08:48:38	pspd-289	198832	EVENT UPDATED -
04/15/21 08:48:38	ps-cadcom01-v	198832	EVENT REMARK - ** VEH search completed at 04/15/21 08:48:38
04/15/21 08:48:38	pspd-289	198832	ADD SUPPLEMENTAL- Revision Number: 1, Supplemental Type: Vehicle, UnitId: 4C16
04/15/21 08:48:41	\$4B17	825187	EVENT REMARK - Vehicle Code is: 2p5318/17490
04/15/21 08:48:41	\$4B17	825187	UNIT UPDATED - Unit: 4B17, Status: UC, Location: 13617 BEACHWOOD AVE CLEV, Employees: 825187
04/15/21	\$4B17	825187	EVENT REMARK - s d r 360 no fresh / wcs 0634 2072 / dfsm 93056 dfsd 8-5-21 /

08:48:42			New equipment list for Unit [4B17] : AB437:1, SGD560560M:1
04/15/21 08:48:42	\$4B17	825187	UNIT UPDATED - Unit: 4B17, Status: UU, Location: 13617 BEACHWOOD AVE CLEV, Employees: 825187
04/15/21 08:48:43	\$4B17	825187	UNIT UPDATED - Unit: 4B17, Status: UE, Location: 13617 BEACHWOOD AVE CLEV, Employees: 199160, 825187
04/15/21 08:48:44	\$4B17	825187	UNIT UPDATED - Unit: 4B17, Status: UC, Location: 13617 BEACHWOOD AVE CLEV, Employees: 199160, 825187
04/15/21 08:49:42	pspd-289	198832	EVENT REMARK - 4D11 RESP AND HANDLING CRIME SCN LOG
04/15/21 08:49:42	pspd-288	994895	EVENT REMARK - D11 TO RELIEVE C37
04/15/21 08:49:54	\$4B17	825187	EVENT UPDATED - Total Assigned Units: 17,
04/15/21 08:49:54	\$4B17	825187	EVENT REMARK - assisted wcs-1
04/15/21 08:49:54	\$4B17	825187	DISPOSITION ASSIGNED - ASST
04/15/21 08:49:54	\$4B17	825187	UNIT UPDATED - Unit: 4B17, Status: AM, Location: , Employees: 199160, 825187
04/15/21 08:51:16	pspd-288	994895	EVENT UPDATED - Total Assigned Units: 16,
04/15/21 08:51:16	pspd-288	994895	DISPOSITION ASSIGNED - ASST
04/15/21 08:51:16	pspd-288	994895	UNIT UPDATED - Unit: 4S12, Status: AM, Location: , Employees: 993354
04/15/21 08:51:25	pspd-289	198832	EVENT REMARK - 4S12 COMP- PERIMETERS ESTABLISHED
04/15/21 08:52:04	pspd-288	994895	EVENT UPDATED - Total Assigned Units: 17,
04/15/21 08:52:04	pspd-288	994895	UNIT UPDATED - Unit: 4S50, Status: DP, Location: 13617 BEACHWOOD AVE CLEV, Employees:
04/15/21 08:53:11	pspd-300	993187	EVENT REMARK - PER EMS THIS FATAL SHOOTING
04/15/21 08:53:21	pspd-300	993187	EVENT REMARK - NOTIFYING THE CCSO
04/15/21 08:55:13	\$4D11	990964	EVENT REMARK - Vehicle Code is: 5p0585/14802
04/15/21 08:55:13	\$4D11	990964	UNIT UPDATED - Unit: 4D11, Status: UC, Location: 13617 BEACHWOOD AVE CLEV, Employees: 990964
04/15/21 08:55:15	\$4D11	990964	EVENT REMARK - no new damage dfsd 07-03-21 dfsm 125657 tour of duty 0800-1600 New equipment list for Unit [4D11] : SGC983588M:1, AB451:1, FAK473:1
04/15/21 08:55:15	\$4D11	990964	UNIT UPDATED - Unit: 4D11, Status: UU, Location: 13617 BEACHWOOD AVE CLEV, Employees: 990964
04/15/21 08:55:16	\$4D11	990964	UNIT UPDATED - Unit: 4D11, Status: UC, Location: 13617 BEACHWOOD AVE CLEV, Employees: 990964
04/15/21 08:58:51	pspd-288	994895	EVENT REMARK - D18 - RESIDENT OF THE 1ST WHI HSE // OK TO LET HER IN // S14 OK TO KEEP AN EYE
04/15/21 09:00:12	\$4B11	202104	EVENT REMARK - Tracking device 00037056/MDT/Default System cleared. Tracking device 00037056/MDT/Default System set. New equipment list for Unit [4B11] :
04/15/21 09:00:12	\$4B11	202104	UNIT UPDATED - Unit: 4B11, Status: DC, Location: 13617 BEACHWOOD AVE CLEV, Employees: 202104
04/15/21 09:00:13	\$4B11	202104	UNIT UPDATED - Unit: 4B11, Status: DC, Location: 13617 BEACHWOOD AVE CLEV, Employees: 202104
04/15/21 09:00:14	\$4B11	202104	UNIT UPDATED - Unit: 4B11, Status: UC, Location: 13617 BEACHWOOD AVE CLEV, Employees: 202104
04/15/21 09:00:49	\$4D11	990964	UNIT UPDATED - Unit: 4D11, Status: AR, Location: 13617 BEACHWOOD AVE CLEV, Employees: 990964
04/15/21 09:02:32	pspd-300	993187	EVENT REMARK - CCSO NOTIFIED

04/15/21 09:04:13	pspd-289	198832	EVENT REMARK - REQ TO NOTIFY RESD AND TO MAKE SURE EVERYONE IS OK
04/15/21 09:05:20	pspd-288	994895	EVENT REMARK - ANOTHER CALL FROM RTCC \
04/15/21 09:05:56	pspd-300	993187	EVENT REMARK - CCSO TO NOTIFY BCI ALSO
04/15/21 09:06:22	pspd-288	994895	EVENT REMARK - CONF W/ LOWTHER #2367
04/15/21 09:06:39	pspd-300	993187	EVENT REMARK - UNIONS (ALL) NOTIFIED
04/15/21 09:09:27	pspd-289	198832	EVENT REMARK - 2 UC UNITS IN THE AREA TO ASSIST WITH MONITORING THE AREA
04/15/21 09:09:30	pspd-289	198832	EVENT UPDATED - Total Assigned Units: 18,
04/15/21 09:09:30	pspd-289	198832	UNIT UPDATED - Unit: 9837, Status: DP, Location: 13617 BEACHWOOD AVE CLEV, Employees:
04/15/21 09:09:31	pspd-289	198832	UNIT UPDATED - Unit: 9837, Status: AR, Location: 13617 BEACHWOOD AVE CLEV, Employees:
04/15/21 09:09:48	pspd-288	994895	EVENT UPDATED - Total Assigned Units: 17,
04/15/21 09:09:48	pspd-288	994895	DISPOSITION ASSIGNED - ASST
04/15/21 09:09:48	pspd-288	994895	UNIT UPDATED - Unit: 4C37, Status: AM, Location: , Employees: 202035
04/15/21 09:11:39	\$4B11	202104	EVENT REMARK - Vehicle Code is: 2p5256, 17436
04/15/21 09:11:39	\$4B11	202104	UNIT UPDATED - Unit: 4B11, Status: UC, Location: 13617 BEACHWOOD AVE CLEV, Employees: 202104
04/15/21 09:11:40	\$4B11	202104	EVENT REMARK - 4/15/21, tod 0800-1600, 360 dents rust and scratches, dfsd 7/2/21, dfsm 126019, wcs 4979 and 0595 New equipment list for Unit [4B11] : AB407:1, W675020M:1, FAK679:1
04/15/21 09:11:40	\$4B11	202104	UNIT UPDATED - Unit: 4B11, Status: UU, Location: 13617 BEACHWOOD AVE CLEV, Employees: 202104
04/15/21 09:11:41	\$4B11	202104	UNIT UPDATED - Unit: 4B11, Status: UE, Location: 13617 BEACHWOOD AVE CLEV, Employees: 458, 202104
04/15/21 09:11:42	\$4B11	202104	UNIT UPDATED - Unit: 4B11, Status: UC, Location: 13617 BEACHWOOD AVE CLEV, Employees: 458, 202104
04/15/21 09:11:46	pspd-288	994895	UNIT UPDATED - Unit: 4D18, Status: AR, Location: 13617 BEACHWOOD AVE CLEV, Employees:
04/15/21 09:12:03	pspd-288	994895	EVENT REMARK - D18 - ANOTHER RESIDENT LIVES 2 DOORS DOWN, REQ OK TO ESCORT / S14 OK
04/15/21 09:13:55	pspd-288	994895	EVENT REMARK - S13 - FRIENDS COMING ON SCN
04/15/21 09:13:58	pspd-289	198832	EVENT REMARK - HAVE SOME FRIENDS SHOWING UP ON SCN
04/15/21 09:14:15	pspd-289	198832	EVENT UPDATED - Total Assigned Units: 18,
04/15/21 09:14:15	pspd-289	198832	UNIT UPDATED - Unit: 8840, Status: DP, Location: 13617 BEACHWOOD AVE CLEV, Employees:
04/15/21 09:14:16	pspd-289	198832	UNIT UPDATED - Unit: 8840, Status: AR, Location: 13617 BEACHWOOD AVE CLEV, Employees:
04/15/21 09:14:19	pspd-289	198832	EVENT REMARK - 8840 COPIES
04/15/21 09:14:55	pspd-289	198832	EVENT REMARK - AT THE SOUTH END OF 134 WHERE THE MEDIA IS
04/15/21 09:15:43	pspd-289	198832	EVENT REMARK - BEACHWOOD SIDE**
04/15/21 09:16:18	pspd-288	994895	EVENT REMARK - D18 - COMMUNITY RELATIONS ON SCN
04/15/21 09:20:15	pspd-288	994895	EVENT REMARK - F17 - ML IN BLU & PINK HOODIE/ BLU JNS IS ACROSS THE STREET ON 134
04/15/21 09:21:32	pspd-288	994895	EVENT REMARK - S14 - EVERYONE ADV TO TAC
04/15/21 09:23:19	pspd-289	198832	EVENT REMARK - 4S14 -- WILL NEED ANOTHER CAR--TO GO DOWN 136 TO MAKE SURE NOBODY COMES OVER

04/15/21 09:23:20	pspd-289	198832	UNIT UPDATED - Unit: 4S14, Status: EC, Location: 13617 BEACHWOOD AVE CLEV, Employees:
04/15/21 09:23:27	pspd-289	198832	EVENT REMARK - 4B11 ON 136
04/15/21 09:26:31	\$4G14	2512	EVENT UPDATED - Total Assigned Units: 19,
04/15/21 09:26:31	\$4G14	2512	UNIT UPDATED - Unit: 4G14, Status: DP, Location: 13617 BEACHWOOD AVE CLEV, Employees: 2512
04/15/21 09:27:42	\$4G14	2512	UNIT UPDATED - Unit: 4G14, Status: ER, Location: 13617 BEACHWOOD AVE CLEV, Employees: 2512
04/15/21 09:29:06	pspd-289	198832	EVENT REMARK - 4B15 ON 136
04/15/21 09:29:19	pspd-289	198832	EVENT REMARK - PIT BULL HEADED TOWARDS OFFICERS- HE FRIENDLY
04/15/21 09:31:21	pspd-289	198832	EVENT REMARK - 4B15 ON SCN- BUT DOES NOT HAVE THEIR CAR-
04/15/21 09:40:34	pspd-289	198832	EVENT REMARK - 4B11 -- TO STAY ON 136 PER 5S14- 4B15 TO PATROL FOR CROWDS
04/15/21 09:40:35	pspd-289	198832	UNIT UPDATED - Unit: 4B11, Status: EC, Location: 13617 BEACHWOOD AVE CLEV, Employees: 458, 202104
04/15/21 09:40:47	pspd-289	198832	EVENT REMARK - CORR*** 4S14
04/15/21 09:42:35	\$4B15	358	EVENT REMARK - Vehicle Code is: 2p5315/17826
04/15/21 09:42:35	\$4B15	358	EVENT REMARK - tod:0800-1600 360 dsr no new damage dfsd 8-13-21 dfsm 86827 wcs 9381/1376 partner p.o. huskey jr #2121 New equipment list for Unit [4B15] : AB453:1, SGW539545M:1, FAK389:1
04/15/21 09:42:35	\$4B15	358	UNIT UPDATED - Unit: 4B15, Status: UC, Location: 13617 BEACHWOOD AVE CLEV, Employees: 358
04/15/21 09:42:35	\$4B15	358	UNIT UPDATED - Unit: 4B15, Status: UU, Location: 13617 BEACHWOOD AVE CLEV, Employees: 358
04/15/21 09:42:36	\$4B15	358	UNIT UPDATED - Unit: 4B15, Status: UC, Location: 13617 BEACHWOOD AVE CLEV, Employees: 358
04/15/21 09:44:01	pspd-288	994895	EVENT REMARK - S34 - FACEBOOK LIVE HAS IT ON THE NEWS / REQ TO STOP TALKING
04/15/21 09:44:18	pspd-288	994895	EVENT REMARK - BCST OVER TAC
04/15/21 09:47:06	pspd-290	990283	EVENT REMARK - 8836 CONF W/ OWNER
04/15/21 09:47:34	pspd-288	994895	EVENT UPDATED - Total Assigned Units: 18,
04/15/21 09:47:34	pspd-288	994895	DISPOSITION ASSIGNED - ASST
04/15/21 09:47:34	pspd-288	994895	UNIT UPDATED - Unit: 4S13, Status: AV, Location: , Employees:
04/15/21 09:47:40	pspd-290	990283	UNIT UPDATED - Unit: 8836, Status: UV, Location: 13617 BEACHWOOD AVE CLEV, Employees:
04/15/21 09:47:41	pspd-290	990283	EVENT REMARK - New equipment list for Unit [8836] :
04/15/21 09:47:41	pspd-290	990283	UNIT UPDATED - Unit: 8836, Status: UC, Location: 13617 BEACHWOOD AVE CLEV, Employees:
04/15/21 09:48:48	pspd-289	198832	EVENT REMARK - ALL CARS ADV THAT THIS IS BEING RECORDED ON FB LIVE
04/15/21 09:51:30	pspd-289	198832	EVENT REMARK - PER 4S59- EVERYTHING BEING BROADCASTED IS BEING PICKED UP BY MEDIA MICS
04/15/21 09:54:14	pspd-289	198832	EVENT REMARK - 4S14 -- 4B15- MAKE SURE TO GO DOWN 133 TO SEE IF ANY SHERIFFS ARE ON THAT STREET- DONT WANT ANYONE COMING FROM BEHIND
04/15/21 09:54:15	pspd-289	198832	UNIT UPDATED - Unit: 4S14, Status: EC, Location: 13617 BEACHWOOD AVE CLEV, Employees:
04/15/21 09:55:01	pspd-289	198832	EVENT REMARK - 4B15 -- THERE ARE 2 SHERIFFS CARS ON 133
04/15/21 09:55:02	pspd-289	198832	UNIT UPDATED - Unit: 4B15, Status: EC, Location: 13617 BEACHWOOD AVE CLEV, Employees: 358

04/15/21 10:08:08	psct-267	202514	EVENT REMARK - ** LOI information for Event # 202100110000 was viewed at: 04/15/21 10:08:08 ** >>> by: MICHAEL R. MAEHLER on terminal: psct-267
04/15/21 10:08:32	pspd-289	198832	EVENT REMARK - 4B11 -- NO SHERIFFS ON 136
04/15/21 10:08:33	pspd-289	198832	UNIT UPDATED - Unit: 4B11, Status: EC, Location: 13617 BEACHWOOD AVE CLEV, Employees: 458, 202104
04/15/21 10:09:06	pspd-289	198832	EVENT REMARK - 4S14 -- 4B11 GO TO 135 TO MAKE SURE THERE ARE SHERIFFS WITH THE 1 MANS
04/15/21 10:09:07	pspd-289	198832	UNIT UPDATED - Unit: 4S14, Status: EC, Location: 13617 BEACHWOOD AVE CLEV, Employees:
04/15/21 10:10:52	pspd-289	198832	EVENT REMARK - CHIEF ON SCN
04/15/21 10:12:34	pspd-289	198832	EVENT REMARK - 4S14 -- 4B15 2 SHERIFFS ON 133- 1 SHERIFFS ON 134 AND A SHERIFF WITH THE 1 MAN ON 134/BEACHWOOD AS WELL AS THE OTHER SIDE
04/15/21 10:12:35	pspd-289	198832	UNIT UPDATED - Unit: 4S14, Status: EC, Location: 13617 BEACHWOOD AVE CLEV, Employees:
04/15/21 10:16:11	pspd-289	198832	EVENT REMARK - 4S14 -- WILL HAVE SHERIFFS GO TO 136 AND FREE UP 4B11- ALSO 4C16 IS FREED UP
04/15/21 10:16:12	pspd-289	198832	UNIT UPDATED - Unit: 4S14, Status: EC, Location: 13617 BEACHWOOD AVE CLEV, Employees:
04/15/21 10:21:27	\$4B11	202104	EVENT UPDATED - Total Assigned Units: 17,
04/15/21 10:21:27	\$4B11	202104	EVENT REMARK - info rec, assisted setting perimeter of house behind crime scene on E136, relieved by sheriff's per 4S14, WCS 1
04/15/21 10:21:27	\$4B11	202104	DISPOSITION ASSIGNED - INFO
04/15/21 10:21:27	\$4B11	202104	DISPOSITION ASSIGNED - ASST
04/15/21 10:21:27	\$4B11	202104	UNIT UPDATED - Unit: 4B11, Status: AM, Location: , Employees: 458, 202104
04/15/21 10:23:39	\$4B15	358	EVENT UPDATED - Total Assigned Units: 16,
04/15/21 10:23:39	\$4B15	358	EVENT REMARK - asst with crime scene security, wcs1
04/15/21 10:23:39	\$4B15	358	DISPOSITION ASSIGNED - ASST
04/15/21 10:23:39	\$4B15	358	UNIT UPDATED - Unit: 4B15, Status: AM, Location: , Employees: 358
04/15/21 10:24:51	pspd-289	198832	EVENT REMARK - 4D18 -- ESCORTING RESD 4269 E 139- OK PER 4S14
04/15/21 10:24:52	pspd-289	198832	UNIT UPDATED - Unit: 4D18, Status: EC, Location: 13617 BEACHWOOD AVE CLEV, Employees:
04/15/21 10:27:56	pspd-283	996482	EVENT REMARK - 8836 - ENR TO JUSTICE CENTER WITH LAMPKIN TO SHERIFFS OFFICE FROM 4A18
04/15/21 10:43:04	\$4C16	993423	EVENT REMARK - New equipment list for Unit [4C16] : Device 00037183/MDT/Default System added for employee 993423. Tracking device 00037183/MDT/Default System set. Tracking device 00037183/MDT/Default System set for employee 993423.
04/15/21 10:43:04	\$4C16	993423	UNIT UPDATED - Unit: 4C16, Status: UE, Location: 13617 BEACHWOOD AVE CLEV, Employees: 993423
04/15/21 10:43:05	\$4C16	993423	UNIT UPDATED - Unit: 4C16, Status: UC, Location: 13617 BEACHWOOD AVE CLEV, Employees: 993423
04/15/21 10:43:06	\$4C16	993423	UNIT UPDATED - Unit: 4C16, Status: AM, Location: 13617 BEACHWOOD AVE CLEV, Employees: 993423
04/15/21 10:43:07	\$4C16	993423	UNIT UPDATED - Unit: 4C16, Status: DC, Location: 13617 BEACHWOOD AVE CLEV, Employees: 993423
04/15/21 10:43:08	\$4C16	993423	UNIT UPDATED - Unit: 4C16, Status: DC, Location: 13617 BEACHWOOD AVE CLEV, Employees: 993423
04/15/21	\$4C16	993423	UNIT UPDATED - Unit: 4C16, Status: DC, Location: 13617 BEACHWOOD AVE CLEV, Employees:

10:43:09			993423	
04/15/21 10:43:15	pspd-283	996482		EVENT REMARK - 9837 - LEAVING THE AREA
04/15/21 10:43:25	pspd-283	996482		EVENT UPDATED - Total Assigned Units: 15,
04/15/21 10:43:25	pspd-283	996482		DISPOSITION ASSIGNED - ASST
04/15/21 10:43:25	pspd-283	996482		UNIT UPDATED - Unit: 9837, Status: AV, Location: , Employees:
04/15/21 10:43:55	\$4C16	993423		UNIT UPDATED - Unit: 4C16, Status: AK, Location: 13617 BEACHWOOD AVE CLEV, Employees: 993423
04/15/21 10:43:56	\$4C16	993423		UNIT UPDATED - Unit: 4C16, Status: AR, Location: 13617 BEACHWOOD AVE CLEV, Employees: 993423
04/15/21 10:44:23	pspd-288	994895		EVENT REMARK - @2512 - FEW3 FAMILY MEMBERS PULLING UP ON 134
04/15/21 10:44:48	pspd-283	996482		EVENT REMARK - 4D18 - SMALL NUMBER OF FAMILY GATHERING 134/CAINE
04/15/21 10:50:44	pspd-297	994423		EVENT REMARK - ** LOI information for Event # 202100110000 was viewed at: 04/15/21 10:50:44 ** >>> by: JACQUELINE MIZIKAR on terminal: pspd-297
04/15/21 10:53:56	pspd-289	198832		EVENT REMARK - 4D18 -- GENTLEMAN- CLAIMING TO BE A PARENT WANTING TO SPEAK TO A HOMICIDE DETECTIVE- 4S14 WILL LET HIM KNOW
04/15/21 10:53:57	pspd-289	198832		UNIT UPDATED - Unit: 4D18, Status: EC, Location: 13617 BEACHWOOD AVE CLEV, Employees:
04/15/21 11:04:09	pspd-288	994895		EVENT REMARK - ER D4
04/15/21 11:04:09	pspd-288	994895		UNIT UPDATED - Unit: 4A18, Status: DW, Location: 13617 BEACHWOOD AVE CLEV, Employees: 483
04/15/21 11:04:23	pspd-289	198832		EVENT REMARK - 4S14 REQ 4O11 AND 4O13 TO RESP TO 134/CAINE TO ASST WITH FAMILY
04/15/21 11:04:33	pspd-289	198832		EVENT UPDATED - Total Assigned Units: 16,
04/15/21 11:04:33	pspd-289	198832		UNIT UPDATED - Unit: 4O11, Status: DP, Location: 13617 BEACHWOOD AVE CLEV, Employees: 994674
04/15/21 11:08:37	pspd-289	198832		EVENT UPDATED - Total Assigned Units: 17,
04/15/21 11:08:37	pspd-289	198832		UNIT UPDATED - Unit: 4O13, Status: DP, Location: 13617 BEACHWOOD AVE CLEV, Employees:
04/15/21 11:11:29	pspd-289	198832		EVENT REMARK - SHERIFFS CARS ON 133- HANDLING PERIMETER
04/15/21 11:13:12	\$4O11	994674		UNIT UPDATED - Unit: 4O11, Status: ER, Location: 13617 BEACHWOOD AVE CLEV, Employees: 994674
04/15/21 11:15:21	\$4A18	483		EVENT REMARK - Tracking device 00037138/MDT/Default System cleared. Tracking device 00037138/MDT/Default System set. New equipment list for Unit [4A18] :
04/15/21 11:15:21	\$4A18	483		UNIT UPDATED - Unit: 4A18, Status: DC, Location: 13617 BEACHWOOD AVE CLEV, Employees: 483
04/15/21 11:15:22	\$4A18	483		UNIT UPDATED - Unit: 4A18, Status: DC, Location: 13617 BEACHWOOD AVE CLEV, Employees: 483
04/15/21 11:15:23	\$4A18	483		UNIT UPDATED - Unit: 4A18, Status: UC, Location: 13617 BEACHWOOD AVE CLEV, Employees: 483
04/15/21 11:20:48	\$4O11	994674		UNIT UPDATED - Unit: 4O11, Status: AR, Location: 13617 BEACHWOOD AVE CLEV, Employees: 994674
04/15/21 11:20:49	\$4O11	994674		UNIT UPDATED - Unit: 4O11, Status: AR, Location: 13617 BEACHWOOD AVE CLEV, Employees: 994674
04/15/21 11:23:57	\$4C16	993423		EVENT REMARK - Tracking device 00037183/MDT/Default System cleared. Tracking device 00037183/MDT/Default System set. New equipment list for Unit [4C16] :
04/15/21 11:23:57	\$4C16	993423		UNIT UPDATED - Unit: 4C16, Status: DC, Location: 13617 BEACHWOOD AVE CLEV, Employees: 993423

04/15/21 11:23:58	\$4C16	993423	UNIT UPDATED - Unit: 4C16, Status: DC, Location: 13617 BEACHWOOD AVE CLEV, Employees: 993423
04/15/21 11:23:59	\$4C16	993423	UNIT UPDATED - Unit: 4C16, Status: UC, Location: 13617 BEACHWOOD AVE CLEV, Employees: 993423
04/15/21 12:00:12	pspd-288	994895	EVENT UPDATED - Total Assigned Units: 16,
04/15/21 12:00:12	pspd-288	994895	EVENT REMARK - ASST
04/15/21 12:00:12	pspd-288	994895	DISPOSITION ASSIGNED - ASST
04/15/21 12:00:12	pspd-288	994895	UNIT UPDATED - Unit: 4S50, Status: AV, Location: , Employees:
04/15/21 12:17:07	\$4O11	994674	EVENT UPDATED - Total Assigned Units: 15,
04/15/21 12:17:07	\$4O11	994674	DISPOSITION ASSIGNED - COMP
04/15/21 12:17:07	\$4O11	994674	UNIT UPDATED - Unit: 4O11, Status: AM, Location: , Employees: 994674
04/15/21 12:17:08	\$4O11	994674	EVENT REMARK - confer with victim from homicide family,chief, commander, assisted 4A18, wcs 1 comp
04/15/21 12:31:35	\$4D17	202059	EVENT REMARK - Vehicle Code is: 14853/002p5128
04/15/21 12:31:35	\$4D17	202059	UNIT UPDATED - Unit: 4D17, Status: UC, Location: 13617 BEACHWOOD AVE CLEV, Employees: 202059
04/15/21 12:31:36	\$4D17	202059	EVENT REMARK - dsr wear and tear 360, dfsd 6/9/21, dfsm 164220, tour 4/15/21 0800-1600, wcs 0060 New equipment list for Unit [4D17] : AB414:1, SGV909842V:1, FAK233:1
04/15/21 12:31:36	\$4D17	202059	UNIT UPDATED - Unit: 4D17, Status: UU, Location: 13617 BEACHWOOD AVE CLEV, Employees: 202059
04/15/21 12:31:37	\$4D17	202059	UNIT UPDATED - Unit: 4D17, Status: UC, Location: 13617 BEACHWOOD AVE CLEV, Employees: 202059
04/15/21 12:32:27	\$4D11	990964	EVENT REMARK - Tracking device 0003713A/MDT/Default System cleared. Tracking device 0003713A/MDT/Default System set. New equipment list for Unit [4D11] :
04/15/21 12:32:27	\$4D11	990964	UNIT UPDATED - Unit: 4D11, Status: DC, Location: 13617 BEACHWOOD AVE CLEV, Employees: 990964
04/15/21 12:32:28	\$4D11	990964	UNIT UPDATED - Unit: 4D11, Status: DC, Location: 13617 BEACHWOOD AVE CLEV, Employees: 990964
04/15/21 12:32:29	\$4D11	990964	UNIT UPDATED - Unit: 4D11, Status: UC, Location: 13617 BEACHWOOD AVE CLEV, Employees: 990964
04/15/21 12:32:41	\$4D11	990964	UNIT UPDATED - Unit: 4D11, Status: AR, Location: 13617 BEACHWOOD AVE CLEV, Employees: 990964
04/15/21 13:21:29	pspd-288	994895	EVENT UPDATED - Total Assigned Units: 14,
04/15/21 13:21:29	pspd-288	994895	DISPOSITION ASSIGNED - ASST
04/15/21 13:21:29	pspd-288	994895	UNIT UPDATED - Unit: 4O13, Status: AV, Location: , Employees:
04/15/21 13:29:40	pspd-288	994895	EVENT UPDATED - Total Assigned Units: 13,
04/15/21 13:29:40	pspd-288	994895	EVENT REMARK - ASST
04/15/21 13:29:40	pspd-288	994895	DISPOSITION ASSIGNED - ASST
04/15/21 13:29:40	pspd-288	994895	UNIT UPDATED - Unit: 4D11, Status: AM, Location: , Employees: 990964
04/15/21 13:40:06	pspd-288	994895	EVENT REMARK - PER S14 - KEEP THINGS ON TAC UNTIL OTHER WISE MENTIONED
04/15/21 14:20:08	pspd-288	994895	EVENT REMARK - Delete Dispatch Warning
04/15/21 14:20:08	pspd-288	994895	UNIT UPDATED - Unit: 4A18, Status: DW, Location: 13617 BEACHWOOD AVE CLEV, Employees: 483

04/15/21 14:20:48	pspd-288	994895	EVENT UPDATED - Total Assigned Units: 12,
04/15/21 14:20:48	pspd-288	994895	EVENT REMARK - RH DNCB
04/15/21 14:20:48	pspd-288	994895	DISPOSITION ASSIGNED - RH
04/15/21 14:20:48	pspd-288	994895	UNIT UPDATED - Unit: 4A18, Status: AM, Location: , Employees: 483
04/15/21 14:29:15	pspd-288	994895	EVENT REMARK - Delete Dispatch Warning
04/15/21 14:29:15	pspd-288	994895	UNIT UPDATED - Unit: 4C16, Status: DW, Location: 13617 BEACHWOOD AVE CLEV, Employees: 993423
04/15/21 14:29:20	pspd-288	994895	DISPOSITION ASSIGNED - ASST
04/15/21 14:29:20	pspd-288	994895	UNIT UPDATED - Unit: 4C16, Status: AM, Location: , Employees: 993423
04/15/21 14:29:21	pspd-288	994895	EVENT UPDATED - Total Assigned Units: 11,
04/15/21 14:29:21	pspd-288	994895	EVENT REMARK - ASST
04/15/21 14:36:46	pspd-288	994895	EVENT UPDATED - Total Assigned Units: 12,
04/15/21 14:36:46	pspd-288	994895	UNIT UPDATED - Unit: 4C26, Status: DP, Location: 13617 BEACHWOOD AVE CLEV, Employees: 716185
04/15/21 14:36:59	\$4C26	716185	UNIT UPDATED - Unit: 4C26, Status: ER, Location: 13617 BEACHWOOD AVE CLEV, Employees: 716185
04/15/21 14:37:31	pspd-288	994895	EVENT REMARK - 134/CAINE
04/15/21 14:37:31	pspd-288	994895	UNIT UPDATED - Unit: 4C26, Status: DW, Location: 13617 BEACHWOOD AVE CLEV, Employees: 716185
04/15/21 14:42:54	\$4G14	2512	EVENT UPDATED - Total Assigned Units: 11,
04/15/21 14:42:54	\$4G14	2512	EVENT REMARK - ASST C/W ASSIGNMENT / WCS3
04/15/21 14:42:54	\$4G14	2512	DISPOSITION ASSIGNED - ASST
04/15/21 14:42:54	\$4G14	2512	UNIT UPDATED - Unit: 4G14, Status: AM, Location: , Employees: 2512
04/15/21 15:08:24	\$4D17	202059	EVENT UPDATED - Total Assigned Units: 10,
04/15/21 15:08:24	\$4D17	202059	DISPOSITION ASSIGNED - ASST
04/15/21 15:08:24	\$4D17	202059	UNIT UPDATED - Unit: 4D17, Status: AM, Location: , Employees: 202059
04/15/21 15:08:25	\$4D17	202059	EVENT REMARK - Assist BCI with crime scene security, Crime scene log, BCI to handle, wcs 1
04/15/21 15:13:36	pspd-288	994895	EVENT UPDATED - Total Assigned Units: 9,
04/15/21 15:13:36	pspd-288	994895	DISPOSITION ASSIGNED - ASST
04/15/21 15:13:36	pspd-288	994895	UNIT UPDATED - Unit: 4D18, Status: AV, Location: , Employees:
04/15/21 15:15:40	pspd-288	994895	EVENT REMARK - ** LOI information for Event # 202100110000 was viewed at: 04/15/21 15:15:40 ** >>>> by: JINGER MALAVE on terminal: pspd-288
04/15/21 15:15:46	pspd-288	994895	EVENT REMARK - ** LOI information for Event # 202100110000 was viewed at: 04/15/21 15:15:46 ** >>>> by: JINGER MALAVE on terminal: pspd-288
04/15/21 16:10:59	pspd-288	994895	EVENT REMARK - PER S23 #9257 OK TO CLOSE DOWN TAC
04/15/21 16:46:56	\$4C26	716185	EVENT UPDATED - Total Assigned Units: 8,
04/15/21 16:46:56	\$4C26	716185	EVENT REMARK - asst on crime scene
04/15/21	\$4C26	716185	DISPOSITION ASSIGNED - ASST

16:46:56			
04/15/21 16:46:56	\$4C26	716185	UNIT UPDATED - Unit: 4C26, Status: AM, Location: , Employees: 716185
04/15/21 16:53:23	pspd-288	994895	EVENT UPDATED - Total Assigned Units: 7,
04/15/21 16:53:23	pspd-288	994895	DISPOSITION ASSIGNED - ASST
04/15/21 16:53:23	pspd-288	994895	UNIT UPDATED - Unit: 4S14, Status: AV, Location: , Employees:
04/15/21 16:53:30	pspd-288	994895	EVENT UPDATED - Total Assigned Units: 6,
04/15/21 16:53:30	pspd-288	994895	DISPOSITION ASSIGNED - ASST
04/15/21 16:53:30	pspd-288	994895	UNIT UPDATED - Unit: 4I77, Status: AV, Location: , Employees:
04/15/21 16:53:37	pspd-288	994895	EVENT UPDATED - Total Assigned Units: 5,
04/15/21 16:53:37	pspd-288	994895	DISPOSITION ASSIGNED - ASST
04/15/21 16:53:37	pspd-288	994895	UNIT UPDATED - Unit: 4S63, Status: AV, Location: , Employees:
04/15/21 16:53:54	pspd-288	994895	EVENT UPDATED - Total Assigned Units: 4,
04/15/21 16:53:54	pspd-288	994895	DISPOSITION ASSIGNED - DNCB
04/15/21 16:53:54	pspd-288	994895	UNIT UPDATED - Unit: 4F17, Status: AM, Location: , Employees: 505, 994366
04/15/21 16:53:59	pspd-288	994895	EVENT UPDATED - Total Assigned Units: 3,
04/15/21 16:53:59	pspd-288	994895	DISPOSITION ASSIGNED - ASST
04/15/21 16:53:59	pspd-288	994895	UNIT UPDATED - Unit: 4S70, Status: AV, Location: , Employees:
04/15/21 16:54:06	pspd-288	994895	EVENT UPDATED - Total Assigned Units: 2,
04/15/21 16:54:06	pspd-288	994895	DISPOSITION ASSIGNED - ASST
04/15/21 16:54:06	pspd-288	994895	UNIT UPDATED - Unit: 8836, Status: AV, Location: , Employees:
04/15/21 16:54:14	pspd-288	994895	EVENT UPDATED - Total Assigned Units: 1,
04/15/21 16:54:14	pspd-288	994895	DISPOSITION ASSIGNED - ASST
04/15/21 16:54:14	pspd-288	994895	UNIT UPDATED - Unit: 8840, Status: AV, Location: , Employees:
04/15/21 16:57:04	pspd-288	994895	EVENT UPDATED - Total Assigned Units: 0,
04/15/21 16:57:04	pspd-288	994895	EVENT CLOSED -
04/15/21 16:57:04	pspd-288	994895	EVENT UPDATED - Closing Employee Id: 994895, Closing Terminal: pspd-288, Closing Time: 04/15/21 16:57:04, Is Open: False,
04/15/21 16:57:04	pspd-288	994895	EVENT REMARK - ASST
04/15/21 16:57:04	pspd-288	994895	DISPOSITION ASSIGNED - ASST
04/15/21 16:57:04	pspd-288	994895	UNIT UPDATED - Unit: 4A16, Status: AM, Location: , Employees: 199138, 706181

4281 E 134th St

Cleveland, Ohio

Google

Street View

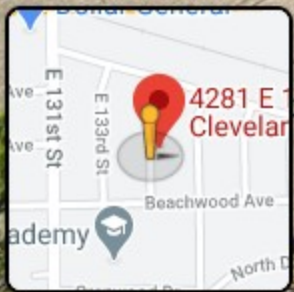

Google



Evidence Log for Case #2021-0925

Agency: Ohio BCI

Prepared by: Special Agent Ashley Ornelas

Date of report: Apr 15, 2021 1:31 PM

All times are offset by: GMT -04:00

Case #: 2021-0925
 Case Opened: Apr 15, 2021 9:15 AM
 Offense: Officer Involved Critical Incident (Other)
 Victims: None
 Witnesses: None
 Suspects: None

Scene #: Scene 1
 Address: 4281 E. 134th Street, Cleveland, OH, 44105 Cuyahoga , United States

Evidence #	Item Description	Location	Collected By	Date/Time
1	Cardboard Box containing: Firearm; Manufacturer: Smith & Wesson - US; Model: M&P9 - Pistol: Semi-Automatic; Caliber: 9mm (Other); Serial Number: HMP6782; Chamber loaded?: No; Magazine loaded?: No; Magazine seated?: No; Hammer cocked?: No; Quantity: 1; Description: 1 cartridge in chamber 7 cartridges in magazine Collected by Det. Robinson #1564 ;	Det. Hale #1187	Special Agent Dan Boerner	Apr 15, 2021 11:07 AM
2	Paper Bag containing: Handcuffs (Other); Quantity: 1; Description: Silver handcuffs ;	Subject	Special Agent Dan Boerner	Apr 15, 2021 11:30 AM
3	Envelope containing: Fired Cartridge Case; Quantity: 1; Description: Speer 9mm Luger cartridge case;	Backyard	Special Agent Dan Boerner	Apr 15, 2021 12:00 PM
4	Envelope containing: Fired Cartridge Case; Quantity: 1; Description: Speer 9mm Luger cartridge case;	Backyard	Special Agent Dan Boerner	Apr 15, 2021 12:01 PM
5	Envelope containing: Fired Cartridge Case; Quantity: 1; Description: Speer 9mm Luger cartridge case;	Backyard	Special Agent Dan Boerner	Apr 15, 2021 12:02 PM
6	Envelope containing: Fired Cartridge Case; Quantity: 1; Description: Speer 9mm Luger cartridge case;	Backyard	Special Agent Dan Boerner	Apr 15, 2021 12:03 PM
7	Paper Bag containing: First Aid Bag (Other); Quantity: 1; Description: Black first aid bag #400;	Backyard	Special Agent Dan Boerner	Apr 15, 2021 12:04 PM

S/A D Boerner
 Signature

04/15/21
 Date

Item	Released By	Released To	Date/Time
<i>1-8</i>	<i>[Signature]</i>	<i>M. Watson #86</i> <i>#116 WATSON</i>	<i>04/15/21 1418</i>

Evidence Log for Case #2021-0925

Agency: Ohio BCI

Prepared by: Special Agent Ashley Ornelas

Date of report: Apr 15, 2021 1:31 PM

All times are offset by: GMT -04:00

Case #: 2021-0925

Case Opened: Apr 15, 2021 9:15 AM

Offense: Officer Involved Critical Incident (Other)

Victims: None

Witnesses: None

Suspects: None

Scene #: Scene 1

Address: 4281 E. 134th Street, Cleveland, OH, 44105 Cuyahoga , United States

Evidence #	Item Description	Location	Collected By	Date/Time
8	Paper Bag containing: First Aid Bag (Other); Quantity: 1; Description: Black first aid bag #508;	Backyard	Special Agent Dan Boerner	Apr 15, 2021 12:04 PM

SIA D B Orlas
Signature

04/15/21
Date

Item	Released By	Released To	Date/Time



INVESTIGATIVE CASE



Ohio Attorney General's Office Bureau of Criminal Investigation

CASE DETAILS

Case Title Officer Involved Critical Incident - Innes Kirk Lee, Jr., Officer Daniel Piper (S)	Case Numbers 2021-0925	Incident No. Not Entered
Location Address 4281 E. 134 Street, Cleveland , OH	Location Name Not Entered	Occurred From: Not Entered Thru: Not Entered
Case Involves Death of Subject, Officer Involved Shooting	Subtype Officer Involved Critical Incident	Unit Crime Scene

Assigned To
SA Daniel P. Boerner (Primary: Special Agent), SAS Edward Lulla (Primary: Supervisor), SA Ashley Ornelas (Special Agent)

Allegation
On Thursday, April 15, 2021, BCI Special Agents Dan Boerner and Ashley Ornelas assisted Lieutenant Miguel Caraballo Sr. and the Cuyahoga County Sheriff's Office with the processing of an outdoor crime scene located at 4281 E. 134th St., Cleveland, Ohio 44105 in regard to an officer-involved critical incident investigation. The scene was photographed as it was found and evidence was collected.

Case Summary
Not Entered

Type	Involved Agency	Agency Case No.	Agency Contact
Incident Agency	Cuyahoga County Sheriff's Office		
Requested By	Cuyahoga County Sheriff's Office		

SUBJECTS

Name	Subject Status	Disposition
Innes Kirk Lee, Jr.	Investigation	Not Entered
Address 3677 E. 147th St. Cleveland OH, 44120	Sex Ethnicity DOB	Disposition Date Not Entered
Phone Not Entered	Male Black 9/12/1995	Identifiers SSN [REDACTED]
	SSN Driver Lic. No.	
	[REDACTED]	
	Not Entered	
Name Officer Daniel Piper	Subject Status Investigation	Disposition Not Entered
Address 1300 Ontario St. Cleveland OH, 44113	Sex Ethnicity DOB	Disposition Date Not Entered
Phone Not Entered	Male Not Entered Not Entered	Identifiers Not Entered
	SSN Driver Lic. No.	
	Not Entered Not Entered	

OTHER PARTIES

Requesting Agency			
Name Cuyahoga County Sheriff's Office	Contact Clifford Pickney (216) 443-6000		
Address 1215 West 3rd Street Cleveland OH, 44113	Tax Id State of Inc.	Not Entered Not Entered	Identifiers Not Entered
Phone (216) 443-6000			

OTHER PARTIES

Victim

Name Unknown				
Address Not Entered	<i>Sex</i>	Not Entered		
	<i>Ethnicity</i>	Not Entered		
	<i>DOB</i>	Not Entered		
Phone Not Entered	<i>SSN</i>	Not Entered	Identifiers	
	<i>Driver Lic. No.</i>	Not Entered	Not Entered	
Phone Not Entered				



Ohio Attorney General's Office
Bureau of Criminal Investigation
 Investigative Report



2021-0925

Officer Involved Critical Incident - Innes Kirk Lee, Jr. (S)

Investigative Activity: Crime Scene Processing
 Activity Date: Thursday, April 15, 2021
 Activity Location: 4281 134th St., Cleveland, Ohio
 Authoring Agent: SA Dan Boerner #135

SUMMARY:

On Thursday, April 15, 2021, BCI Special Agents Dan Boerner and Ashley Ornelas assisted Lieutenant Miguel Caraballo Sr. and the Cuyahoga County Sheriff's Office with the processing of an outdoor crime scene located at 4281 E. 134th St., Cleveland, Ohio 44105 in regard to an officer-involved critical incident investigation. The scene was photographed as it was found and evidence was collected.

DETAILS:

On Thursday, April 15, 2021, at 0913hrs, SA Boerner was contacted by SAS Ed Lulla and was requested to assist Lieutenant Miguel Caraballo Sr. and the Cuyahoga County Sheriff's Office with the processing of an outdoor crime scene located at 4281 E. 134th St., Cleveland, Ohio 44105 in regard to an officer-involved critical incident (OICI) . SA Boerner contacted Lt. Caraballo and learned that earlier this morning officers of the Cleveland Division of Police (CDP) attempted to arrest a male (ID to be Innes Lee Jr.) on an outstanding warrant. Lt. Caraballo reported that during the arrest, Lee reportedly brandished a handgun and was shot by a CDP Officer (ID to be Ofc. Daniel Piper). Lt. Caraballo reported that first aid was rendered and Lee was subsequently declared to be deceased. Lt. Caraballo requested assistance with documenting the scene, examining the scene for items of suspected evidence and collecting items of suspected evidence.

On Thursday, April 15, 2021, at 1056hrs, SA Boerner arrived on scene and met with Lt. Caraballo, Det. Mike Watson and Det. Joe Goudy. SA Boerner learned that the handgun, reportedly brandished by Lee, was currently in the custody of CDP. SA Boerner subsequently met with Det. Hale#1187 of the CDP and obtained possession of the handgun. The handgun was reportedly handled by Ofc. Piper after the shooting and was not made safe. SA Boerner proceeded to photograph the handgun as it was found and collected the same as evidence (Figures , Item 1). The handgun is a black Smith & Wesson, MP9 Shield 9mm S/N: HMP6782 with one (1) cartridge in the chamber and seven (7) cartridges in the magazine.

This document is the property of the Ohio Bureau of Criminal Investigation and is confidential in nature. Neither the document nor its contents are to be disseminated outside your agency except as provided by law - a statute, an administrative rule, or any rule of procedure.



**Ohio Attorney General's Office
Bureau of Criminal Investigation
Investigative Report**



2021-0925

Officer Involved Critical Incident - Innes Kirk Lee, Jr. (S)



Figure 1, Item 1



Figure 2, Item 1

This document is the property of the Ohio Bureau of Criminal Investigation and is confidential in nature. Neither the document nor its contents are to be disseminated outside your agency except as provided by law - a statute, an administrative rule, or any rule of procedure.



Ohio Attorney General's Office
Bureau of Criminal Investigation
Investigative Report



2021-0925

Officer Involved Critical Incident - Innes Kirk Lee, Jr. (S)



Figure 3, Item 1

SA Boerner proceeded to photograph the exterior of 4281 E. 134th St., Cleveland, Ohio 44105 as it was found (Figures 4-9, Overall photographs). The scene can be described as the backyard of 4281 E. 134th St., Cleveland, Ohio 44105 in close proximity to a detached shed. The property was reported to be uninhabited; however, was found to be inhabited during the execution of a search warrant of the interior of the residence.

This document is the property of the Ohio Bureau of Criminal Investigation and is confidential in nature. Neither the document nor its contents are to be disseminated outside your agency except as provided by law - a statute, an administrative rule, or any rule of procedure.

Page 3 of 11

Supervisor Approval: SAS Ed Lulla #117

4/19/2021 7:46 AM



**Ohio Attorney General's Office
Bureau of Criminal Investigation
Investigative Report**



2021-0925

Officer Involved Critical Incident - Innes Kirk Lee, Jr. (S)



Figure 4, Overall photograph



Figure 5, Overall photograph

This document is the property of the Ohio Bureau of Criminal Investigation and is confidential in nature. Neither the document nor its contents are to be disseminated outside your agency except as provided by law - a statute, an administrative rule, or any rule of procedure.

Page 4 of 11

Supervisor Approval: SAS Ed Lulla #117

4/19/2021 7:46 AM



**Ohio Attorney General's Office
Bureau of Criminal Investigation
Investigative Report**



2021-0925

Officer Involved Critical Incident - Innes Kirk Lee, Jr. (S)



Figure 6, Overall photograph



Figure 7, Overall photograph

This document is the property of the Ohio Bureau of Criminal Investigation and is confidential in nature. Neither the document nor its contents are to be disseminated outside your agency except as provided by law - a statute, an administrative rule, or any rule of procedure.



**Ohio Attorney General's Office
Bureau of Criminal Investigation
Investigative Report**



2021-0925

Officer Involved Critical Incident - Innes Kirk Lee, Jr. (S)



Figure 8, Overall photograph



Figure 9, Overall photograph

This document is the property of the Ohio Bureau of Criminal Investigation and is confidential in nature. Neither the document nor its contents are to be disseminated outside your agency except as provided by law - a statute, an administrative rule, or any rule of procedure.



Ohio Attorney General's Office
Bureau of Criminal Investigation
Investigative Report



2021-0925

Officer Involved Critical Incident - Innes Kirk Lee, Jr. (S)

The body of Lee was still present and members of the Cuyahoga County Medical Examiner's Office (CCMEO) were on scene and preparing to conduct their initial survey of Lee. Lee was photographed as he was found, prior to the CCMEO's initial survey (Figures 10-11, Overall body photographs). Lee was found in a supine position with his wrists handcuffed behind his back. Lee had also been covered with a white sheet. CCMEO reported that Lee exhibited several suspected gunshot wounds to the face, to the left chest and to the right leg. Lee was subsequently transported from the scene by CCMEO transport staff. Prior to transport, the handcuffs were removed and collected as evidence (Item 2).

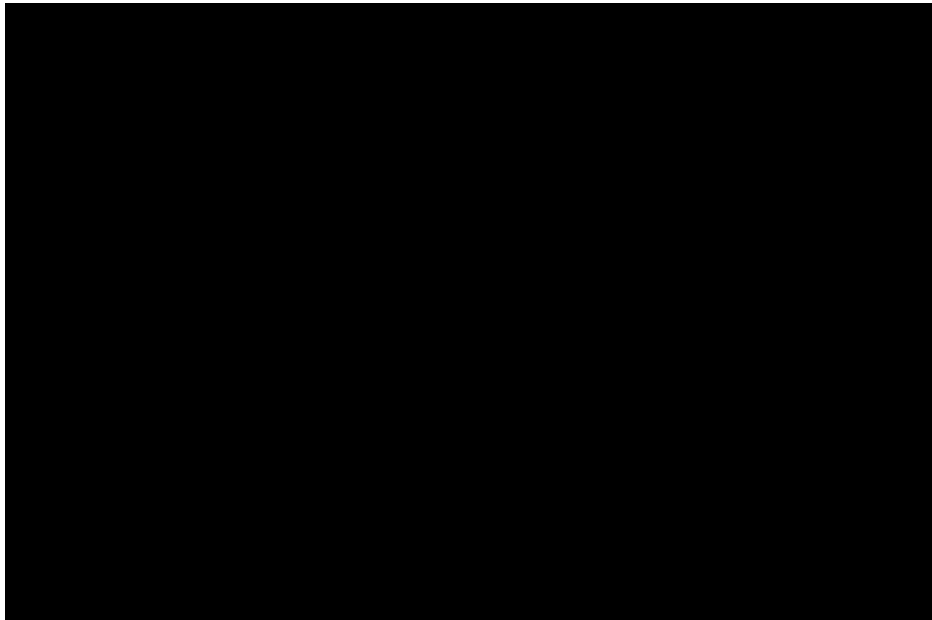

Figure 10, Overall body photograph

This document is the property of the Ohio Bureau of Criminal Investigation and is confidential in nature. Neither the document nor its contents are to be disseminated outside your agency except as provided by law - a statute, an administrative rule, or any rule of procedure.



Ohio Attorney General's Office
Bureau of Criminal Investigation
 Investigative Report



2021-0925

Officer Involved Critical Incident - Innes Kirk Lee, Jr. (S)

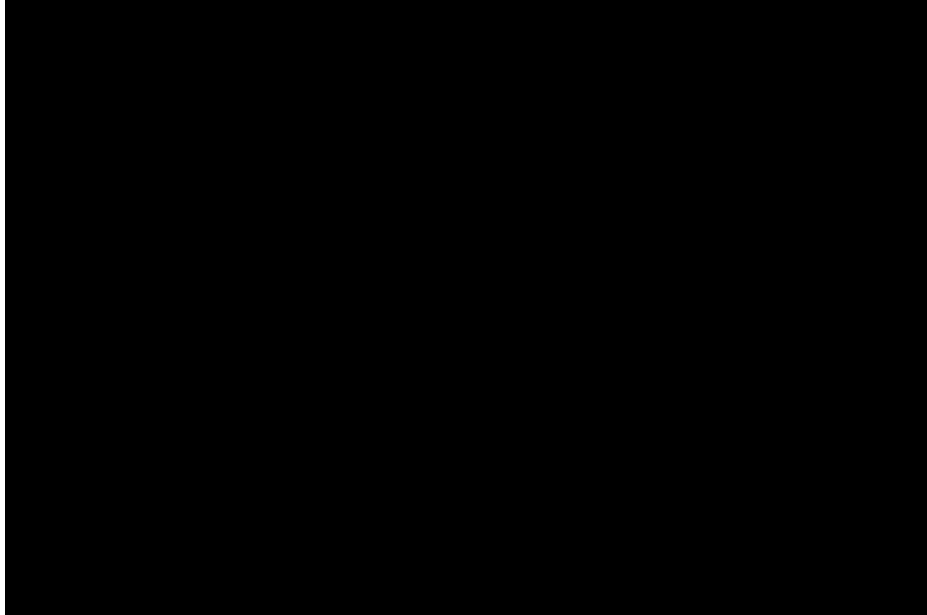

Figure 11, Overall body photograph

The scene was examined for items of suspected evidence and several items of suspected evidence were observed. The items of suspected evidence were photographed as they were found and collected as evidence (Table 1 and Figures 12-14, Items of suspected evidence).

Item #	Description	Location
3	Cartridge case – Speer 9mm Luger	Near detached garage
4	Cartridge case – Speer 9mm Luger	Near detached garage
5	Cartridge case – Speer 9mm Luger	Near detached garage
6	Cartridge case – Speer 9mm Luger	Near detached garage
7	CDP first aid kit #400	Near body of Lee
8	CDP first aid kit #508	Near body of Lee

Table 1, Items of Suspected Evidence

This document is the property of the Ohio Bureau of Criminal Investigation and is confidential in nature. Neither the document nor its contents are to be disseminated outside your agency except as provided by law - a statute, an administrative rule, or any rule of procedure.



Ohio Attorney General's Office
Bureau of Criminal Investigation
Investigative Report



2021-0925

Officer Involved Critical Incident - Innes Kirk Lee, Jr. (S)

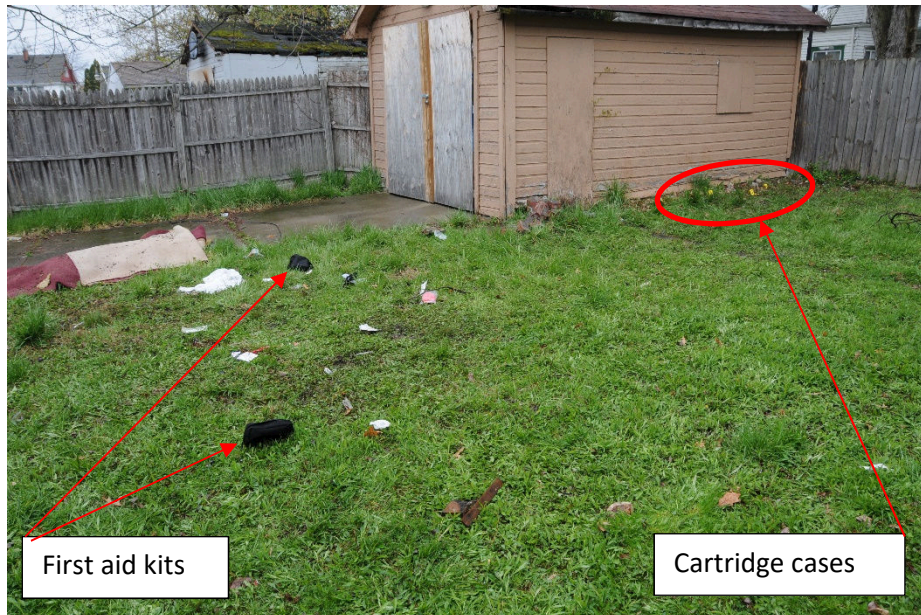

Figure 12, Items of evidence



Figure 13, Items of evidence

This document is the property of the Ohio Bureau of Criminal Investigation and is confidential in nature. Neither the document nor its contents are to be disseminated outside your agency except as provided by law - a statute, an administrative rule, or any rule of procedure.



Ohio Attorney General's Office
Bureau of Criminal Investigation
Investigative Report



2021-0925

Officer Involved Critical Incident - Innes Kirk Lee, Jr. (S)



Figure 14, Items of evidence

Using a Google Earth® image, SA Boerner created a diagram of the property located at 4281 E. 134th St., Cleveland, Ohio 44105 (Figure 15, Overhead diagram). A copy of the diagram was subsequently provided to the agency.

This document is the property of the Ohio Bureau of Criminal Investigation and is confidential in nature. Neither the document nor its contents are to be disseminated outside your agency except as provided by law - a statute, an administrative rule, or any rule of procedure.



Ohio Attorney General's Office
Bureau of Criminal Investigation
Investigative Report



2021-0925

Officer Involved Critical Incident - Innes Kirk Lee, Jr. (S)

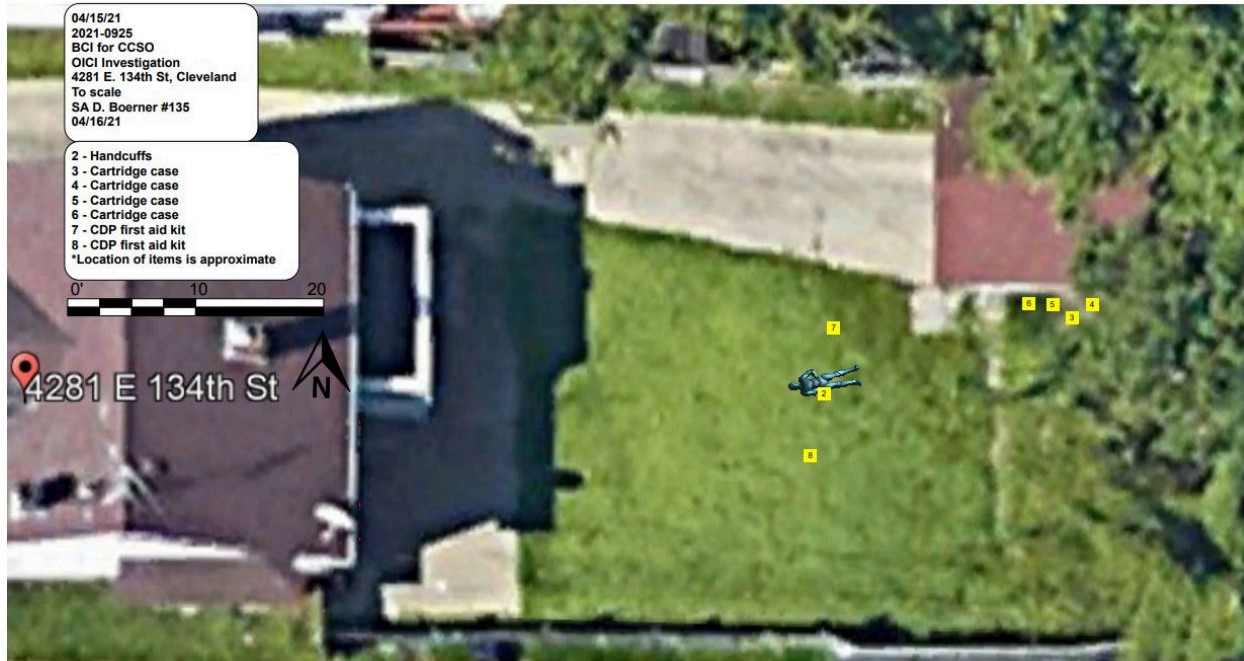

Figure 15, Overhead diagram

An Inventory / Receipt Attachment form was filled out and signed by SA Boerner and Det. Mike Watson #86, a copy of the form was left with Det. Watson for their records. All items of evidence were turned over to the agency to be held as evidence.

The photographs are to be uploaded into Matrix. A CD / DVD copy of the photographs was made and provided to the agency.

A copy of this report should be sent to:

Cuyahoga County Sheriff's Office
Attn: Det. Joe Goudy
Email: jgoudy@cuyahogacounty.us

This document is the property of the Ohio Bureau of Criminal Investigation and is confidential in nature. Neither the document nor its contents are to be disseminated outside your agency except as provided by law - a statute, an administrative rule, or any rule of procedure.



04/15/21
2021-0925
BCI for CCSO
OICI Investigation
4281 E. 134th St, Cleveland
To scale
SA D. Boerner #135
04/16/21

- 2 - Handcuffs
 - 3 - Cartridge case
 - 4 - Cartridge case
 - 5 - Cartridge case
 - 6 - Cartridge case
 - 7 - CDP first aid kit
 - 8 - CDP first aid kit
- *Location of items is approximate

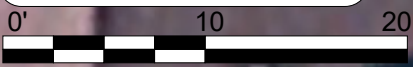

4281 E 134th St N



PARTY DETAILS



Ohio Attorney General's Office Bureau of Criminal Investigation

Officer Involved Critical Incident - Innes Kirk Lee, Jr., Officer Daniel Piper (S)

Cases: 2021-0925 (502-9265)

INNES KIRK LEE + 1 (S), UNKNOWN (V)

Innes Kirk Lee, Jr. - **Subject**

Involved Individual

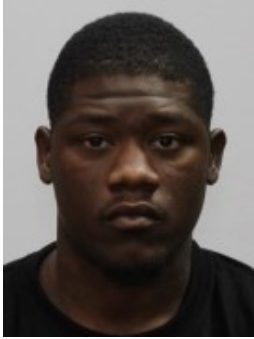

Age
25 years
Born Sep 12, 1995
Age at Incident 25
SSN
[REDACTED]
Gender
Male
Ethnicity
Black

Identifiers
SSN [REDACTED]

Subject Status
Deceased

Comment
Not Entered

Traits
Not Entered

Aliases
Not Entered

INCARCERATIONS (*ARRESTS)

Date	Agency
Not Entered	

WARRANTS

Date	Number	Agency
Not Entered		

CASE

Case No./Type	Status	Charges
2021-0925 Investigation	Investigation	

CONTACT

Home (Current) Phone
3677 E. 147th St. Not Entered
Cleveland, OH 44120
Cuyahoga County

PHYSICAL CHARACTERISTICS

Eyes: Brown
Hair Color: Black
Height: 5'6"
Weight: 170

INJURIES

Not Entered

AFFILIATIONS

Employment Not Entered Education Not Entered Threat Groups Not Entered

PERSONAL

Relationships

Officer Daniel Piper - Subject*Officer Involved*

Age
Not Entered

SSN
Not Entered

Gender
Male

Ethnicity
Not Entered

Identifiers

Subject Status
Not Entered

Comment
Not Entered

Traits
Not Entered

Aliases
Not Entered

INCARCERATIONS (*ARRESTS)

Date	Agency
Not Entered	

WARRANTS

Date	Number	Agency
Not Entered		

CASE

Case No./Type	Status	Charges
2021-0925 Investigation	Investigation	

CONTACT

Business (Current)	Phone
1300 Ontario St. Cleveland, OH 44113 Cuyahoga County	Not Entered

PHYSICAL CHARACTERISTICS

Not Entered

INJURIES

Not Entered

AFFILIATIONS

Employment	Education	Threat Groups
Not Entered	Not Entered	Not Entered

PERSONAL

Relationships

Unknown - Victim

Victim



Age
Not Entered

SSN
Not Entered

Gender
Not Entered

Ethnicity
Not Entered

Identifiers

Victim Status
Not Entered

Comment
Not Entered

Traits
Not Entered

Aliases
Not Entered

INCARCERATIONS (*ARRESTS)

Date	Agency
Not Entered	

WARRANTS

Date	Number	Agency
Not Entered		

CASE

Case No./Type	Status	Charges
2021-0925 Investigation	Investigation	

CONTACT

Phone
Not Entered

PHYSICAL CHARACTERISTICS

Not Entered

INJURIES

Not Entered

AFFILIATIONS

Employment	Education	Threat Groups
Not Entered	Not Entered	Not Entered

PERSONAL

Relationships

Cuyahoga County Sheriff's Office - Other Party

Requesting Agency

Identifiers

Other Party Status

Not Entered

CASE

Case No./Type	Status	Charges
2021-0925 Investigation	Investigation	

CONTACT

Business 1215 West 3rd Street Cleveland, OH 44113 Cuyahoga County	Phone <i>Business:</i> (216) 443-6000
--	--

PERSONAL

Relationships

**E21032550 - 27 - 27-D-4G - STAB / GUNSHOT / PENETRATING TRAUMA - CENTRAL WOUNDS
4281 E 134TH ST CLEV**
 System Comments

Date/Time	Terminal	Operator	
04/15/21 08:25:08	psed-254	199755	EVENT CREATED - Type: 27 - 27-D-4G - STAB / GUNSHOT / PENETRATING TRAUMA - CENTRAL WOUNDS, Location: 13617 BEACHWOOD AVE CLEV, Agency: CEMS, Group: CEMS, Beat: 21, Status: P, Priortiy: 2
04/15/21 08:25:08	psed-254	199755	INITIAL CALL - Call Source: CPD, Caller Name: , Caller Phone Number: , Caller Address:
04/15/21 08:25:08	psed-254	199755	EVENT REMARK - Patient Number: 1 Chief Complaint: Stab / Gunshot / Penetrating Trauma Age unknown, Male, Consciousness unknown, Breathing status unknown. Dispatch CAD Code: 27D04G Response Text: 1 Determinant Level: CENTRAL wounds Suffix Text: Gunshot KQ: The location of the assailant is not known. KQ: He has received a gunshot wound. KQ: It's not known when this happened. KQ: It's not known if there is SERIOUS bleeding. KQ: The wound is in a CENTRAL location. KQ: It's not known if there is more than one wound. KQ: It's not known if he is completely alert (responding appropriately).
04/15/21 08:25:09	ps- cadcom01-v	199755	EVENT REMARK - ** LOI search completed at 04/15/21 08:25:09
04/15/21 08:25:25	psed-252	7731	EVENT UPDATED - First Unit Dispatched Time: 04/15/21 08:25:25, Status Code: A, Total Assigned Units: 1,
04/15/21 08:25:25	psed-252	7731	EVENT REMARK - ** Recommended unit MED11 for requirement 1AMB (3.0 mi) ** Recommended unit CAPT1 for requirement 1CAPT (6.6 mi)
04/15/21 08:25:25	psed-252	7731	UNIT UPDATED - Unit: MED11, Status: DS, Location: 13617 BEACHWOOD AVE CLEV, Employees: 198560, 198825
04/15/21 08:26:20	psed-254	199755	EVENT UPDATED - Common Event Revision Number: 2, CrossStreet1: CAINE AVE, CrossStreet2: BEACHWOOD AVE, Location: 4281 E 134TH ST CLEV, Nature: U M GSW/UNK UU CPD ON ASU , ZipCode: 44105,
04/15/21 08:26:20	psed-254	199755	EVENT REMARK - ** Event Location changed from "13617 BEACHWOOD AVE CLEV" to "4281 E 134TH ST CLEV" at: 04/15/21 08:26:20 ** >>>> by: KATHRYN SIJAKOVIC on terminal: psed-254
04/15/21 08:26:20	ps- cadcom01-v	199755	EVENT REMARK - ** LOI search completed at 04/15/21 08:26:20
04/15/21 08:26:27	psed-257	0	UNIT UPDATED - Unit: MED11, Status: ~, Location: 13617 BEACHWOOD AVE CLEV, Employees: 198560, 198825
04/15/21 08:26:40	psed-255	2007707	EVENT REMARK - Duplicate Event:Location = 4281 E 134TH ST CLEV, Cross Street 1 = CAINE AVE, Cross Street 2 = BEACHWOOD AVE, Type = 27 53 STAB / GUNSHOT / PENETRATING TRAUMA CITIZEN ASSIST / SERVICE CALL, Subtype = 27-D-4G 53-B-03 CENTRAL WOUNDS MEDICAL ASSISTANCE, Call Source = CPD, Alarm Level = 0
04/15/21 08:26:40	psed-255	2007707	EVENT REMARK - Patient Number: 1 Chief Complaint: Stab / Gunshot / Penetrating Trauma Age unknown, Male, Consciousness unknown, Breathing status unknown. Dispatch CAD Code: 27D04G Response Text: 1 Determinant Level: CENTRAL wounds Suffix Text: Gunshot KQ: The location of the assailant is not known. KQ: He has received a gunshot wound. KQ: It's not known when this happened. KQ: It's not known if there is SERIOUS bleeding. KQ: The wound is in a CENTRAL location. KQ: It's not known if there is more than one wound. KQ: It's not known if he is completely alert (responding appropriately). ** LOI search completed at 04/15/21 08:25:43 PER CPD, PT IS AT THIS ADDRESS PER CPD, STAGE - UNKNOWN WHO IS THE PT OR THE SUSPECT
04/15/21 08:26:40	psed-255	2007707	EVENT REMARK - End of Duplicate Event data
04/15/21 08:26:40	psed-255	2007707	EVENT REMARK - ** Cross Referenced to Event # E21032551 at: 04/15/21 08:26:40 ** >>>> by: MyLINH LAM on terminal: psed-255
04/15/21 08:26:42	psfd-294	8681	EVENT REMARK - Duplicate Event:Location = 4281 E 134TH ST CLEV, Cross Street 1 = CAINE AVE, Cross Street 2 = BEACHWOOD AVE, Type = 27 53 STAB / GUNSHOT / PENETRATING

TRAUMA CITIZEN ASSIST / SERVICE CALL, Subtype = 27-D-4G 53-B-03 CENTRAL WOUNDS
 MEDICAL ASSISTANCE, Call Source = CPD, Alarm Level = 0

Time	Unit	Event ID	Description
04/15/21 08:26:42	psfd-294	8681	EVENT REMARK - Patient Number: 1 Chief Complaint: Stab / Gunshot / Penetrating Trauma Age unknown, Male, Consciousness unknown, Breathing status unknown. Dispatch CAD Code: 27D04G Response Text: 1 Determinant Level: CENTRAL wounds Suffix Text: Gunshot KQ: The location of the assailant is not known. KQ: He has received a gunshot wound. KQ: It's not known when this happened. KQ: It's not known if there is SERIOUS bleeding. KQ: The wound is in a CENTRAL location. KQ: It's not known if there is more than one wound. KQ: It's not known if he is completely alert (responding appropriately). ** LOI search completed at 04/15/21 08:25:43 PER CPD, PT IS AT THIS ADDRESS PER CPD, STAGE - UNKNOWN WHO IS THE PT OR THE SUSPECT ** Cross Referenced to Event # E21032550 at: 04/15/21 08:26:40 ** >>> by: MyLINH LAM on terminal: psed-255
04/15/21 08:26:42	psfd-294	8681	EVENT REMARK - End of Duplicate Event data
04/15/21 08:26:42	psfd-294	8681	EVENT REMARK - ** Cross Referenced to Event # F21018850 at: 04/15/21 08:26:42 ** >>> by: TIMOTHY P. COUGHLIN on terminal: psfd-294
04/15/21 08:26:42	psfd-294	8681	EVENT CROSS-REFERENCED - E21032551 F21018850
04/15/21 08:26:55	\$MED11	198825	EVENT UPDATED - First Unit Enrouted Time: 04/15/21 08:26:55,
04/15/21 08:26:55	\$MED11	198825	UNIT UPDATED - Unit: MED11, Status: EN, Location: 13617 BEACHWOOD AVE CLEV, Employees: 198560, 198825
04/15/21 08:27:05	psed-254	199755	EVENT REMARK - PER CPD CPR BEING DONE
04/15/21 08:28:02	psed-254	199755	EVENT REMARK - IN BACKYARD AT THIS ADDRESS PER CPD
04/15/21 08:28:29	\$CAPT1	192480	EVENT UPDATED - Total Assigned Units: 2,
04/15/21 08:28:29	\$CAPT1	192480	UNIT UPDATED - Unit: CAPT1, Status: DS, Location: 4281 E 134TH ST CLEV, Employees: 192480
04/15/21 08:28:46	\$CAPT1	192480	UNIT UPDATED - Unit: CAPT1, Status: EN, Location: 4281 E 134TH ST CLEV, Employees: 192480
04/15/21 08:33:12	psed-251	2007709	EVENT UPDATED - First Unit Arrived Time: 04/15/21 08:33:12,
04/15/21 08:33:12	psed-251	2007709	UNIT UPDATED - Unit: MED11, Status: W, Location: 4281 E 134TH ST CLEV, Employees: 198560, 198825
04/15/21 08:33:42	\$MED11	198825	UNIT UPDATED - Unit: MED11, Status: W, Location: 4281 E 134TH ST CLEV, Employees: 198560, 198825
04/15/21 08:37:46	psed-super	0	UNIT UPDATED - Unit: CAPT1, Status: ~, Location: 4281 E 134TH ST CLEV, Employees: 192480
04/15/21 08:41:17	\$CAPT1	192480	UNIT UPDATED - Unit: CAPT1, Status: W, Location: 4281 E 134TH ST CLEV, Employees: 192480
04/15/21 08:41:50	psed-251	2007709	EVENT REMARK - PER UNIT DOA TOD 836
04/15/21 08:42:40	psed-251	2007709	EVENT REMARK - PER UNIT 25 M
04/15/21 08:53:42	psed-257	0	UNIT UPDATED - Unit: MED11, Status: ~, Location: 4281 E 134TH ST CLEV, Employees: 198560, 198825
04/15/21 08:54:22	psed-251	2007709	UNIT UPDATED - Unit: MED11, Status: CU, Location: 4281 E 134TH ST CLEV, Employees: 198560, 198825
04/15/21 09:01:17	psed-257	0	UNIT UPDATED - Unit: CAPT1, Status: ~, Location: 4281 E 134TH ST CLEV, Employees: 192480
04/15/21 09:02:10	psed-251	2007709	UNIT UPDATED - Unit: CAPT1, Status: CU, Location: 4281 E 134TH ST CLEV, Employees: 192480
04/15/21 09:13:42	psed-257	0	UNIT UPDATED - Unit: MED11, Status: ~, Location: 4281 E 134TH ST CLEV, Employees: 198560, 198825
	\$CAPT1	192480	EVENT UPDATED - Primary Employee Id: 192480, Primary Unit Id: CAPT1,

04/15/21 09:16:21	\$CAPT1	192480	EVENT UPDATED - Is Recommend Enabled: False, Total Assigned Units: 1,
04/15/21 09:16:21	\$CAPT1	192480	DISPOSITION ASSIGNED - BU
04/15/21 09:16:21	\$CAPT1	192480	UNIT UPDATED - Unit: CAPT1, Status: AM, Location: 4281 E 134TH ST CLEV, Employees: 192480
04/15/21 09:19:38	psed-252	7731	UNIT UPDATED - Unit: MED11, Status: CU, Location: 4281 E 134TH ST CLEV, Employees: 198560, 198825
04/15/21 09:23:43	psed-252	7731	EVENT UPDATED - Total Assigned Units: 0,
04/15/21 09:23:43	psed-252	7731	DISPOSITION ASSIGNED - DOA
04/15/21 09:23:43	psed-252	7731	UNIT UPDATED - Unit: MED11, Status: AM, Location: 4281 E 134TH ST CLEV, Employees: 198560, 198825
04/15/21 09:23:44	psed-252	7731	EVENT CLOSED -
04/15/21 09:23:44	psed-252	7731	EVENT UPDATED - Closing Employee Id: 7731, Closing Terminal: psed-252, Closing Time: 04/15/21 09:23:44, Is Open: False,

**E21032551 - 27 - 27-D-4G - STAB / GUNSHOT / PENETRATING TRAUMA - CENTRAL WOUNDS
4281 E 134TH ST CLEV**
 System Comments

Date/Time	Terminal	Operator	
04/15/21 08:25:42	psed-255	2007707	EVENT CREATED - Type: 27 - 27-D-4G - STAB / GUNSHOT / PENETRATING TRAUMA - CENTRAL WOUNDS, Location: 4281 E 134TH ST CLEV, Agency: CEMS, Group: CEMS, Beat: 21, Status: P, Priortiy: 2
04/15/21 08:25:42	psed-255	2007707	INITIAL CALL - Call Source: CPD, Caller Name: , Caller Phone Number: , Caller Address: EVENT REMARK - Patient Number: 1 Chief Complaint: Stab / Gunshot / Penetrating Trauma Age unknown, Male, Consciousness unknown, Breathing status unknown. Dispatch CAD Code: 27D04G Response Text: 1 Determinant Level: CENTRAL wounds Suffix Text: Gunshot KQ: The location of the assailant is not known. KQ: He has received a gunshot wound. KQ: It's not known when this happened. KQ: It's not known if there is SERIOUS bleeding. KQ: The wound is in a CENTRAL location. KQ: It's not known if there is more than one wound. KQ: It's not known if he is completely alert (responding appropriately).
04/15/21 08:25:43	ps- cadcom01-v	2007707	EVENT REMARK - ** LOI search completed at 04/15/21 08:25:43
04/15/21 08:26:05	psed-255	2007707	EVENT REMARK - PER CPD, PT IS AT THIS ADDRESS
04/15/21 08:26:32	psed-255	2007707	EVENT REMARK - PER CPD, STAGE - UNKNOWN WHO IS THE PT OR THE SUSPECT
04/15/21 08:26:40	psed-255	2007707	EVENT CLOSED - Duplicate and Cancel
04/15/21 08:26:40	psed-255	2007707	EVENT UPDATED - Closing Comment: Duplicate and Cancel, Closing Employee Id: 2007707, Closing Terminal: psed-255, Closing Time: 04/15/21 08:26:40, Is Open: False, Status Code: C,
04/15/21 08:26:40	psed-255	2007707	EVENT REMARK - ** Cross Referenced to Event # E21032550 at: 04/15/21 08:26:40 ** >>>> by: MyLINH LAM on terminal: psed-255
04/15/21 08:26:40	psed-255	2007707	DISPOSITION ASSIGNED - DUPNCAN
04/15/21 08:26:42	psfd-294	8681	EVENT REMARK - ** Cross Referenced to Event # F21018849 at: 04/15/21 08:26:42 ** >>>> by: TIMOTHY P. COUGHLIN on terminal: psfd-294
04/15/21 08:26:42	psfd-294	8681	EVENT CROSS-REFERENCED - E21032550 F21018849



CLEVELAND DIVISION OF POLICE

GENERAL POLICE ORDER



EFFECTIVE DATE: July 1, 2019	CHAPTER: 2 – Legal	PAGE: 1 of 3	NUMBER: 2.01.01
SUBJECT: USE OF FORCE – DEFINITIONS			
CHIEF: <i>Calvin D. Williams, Chief</i>			

Substantive changes are italicized

PURPOSE: To define terminology used in the Cleveland Division of Police Use of Force policies.

DEFINITIONS:

Canine Apprehension: When a canine is deployed and plays a clear role in the capture of a person. The mere presence of a canine at the scene of an arrest or use of a canine solely to track a subject will not count as a canine apprehension.

Critical Firearm Discharge: *Discharge of a firearm by a member including, but not limited to accidental discharges, discharges at animals, other than to euthanize, and discharges at individuals where no one is struck, as well as discharges by officers employed by an outside law enforcement agency within the jurisdiction of the Division of Police.*

De Minimis Force: Physical interactions meant to guide and/or control a subject that do not constitute reportable force (e.g., use of control holds that do not cause pain and are not reasonably likely to cause pain; using hands or equipment to stop, push back, separate, or escort a person in a manner that does not cause pain, and is not reasonably likely to cause any pain).

De-escalation: The process of taking action to stabilize the situation, reduce the immediacy and level of a threat so that more time, options, and resources are available to resolve the situation and gain voluntary compliance. De-escalation techniques may include, but are not limited to, gathering information about the incident, assessing the risks, verbal persuasion, advisements and warnings, and tactical de-escalation techniques, such as slowing down the pace of the incident, waiting out subjects, creating distance (reactionary gap) between the officer and the threat, repositioning, and requesting additional resources (e.g., specialized CIT officers or negotiators).

Deadly Force: Any action that is likely to cause or does cause death or serious physical harm. It may involve a critical firearm discharge, but also includes any force or instrument of force (e.g., vehicle, edged weapon) capable of causing death or serious physical harm. Deadly force includes firing at or in the direction of a subject, head and/or neck strikes with any hard object, and any action that restricts the blood or oxygen flow through the neck.

FIT (Force Investigation Team): A team within the Internal Affairs Unit comprised of personnel who possess training and expertise from various specialized units. FIT membership shall be tailored to the circumstances of each investigation, but normally includes one or more FIT detectives, the FIT Sergeant, an Office of Professional Standards investigator, an Internal Affairs investigator, and a Homicide Unit supervisory officer, who will serve as the Team's leader. OPS investigators will not participate in criminal investigations.

PAGE: 2 of 3	SUBJECT: USE OF FORCE – DEFINITIONS	NUMBER: 2.01.01
-----------------	--	--------------------

Force: Means the following actions by an officer: any physical strike, (e.g., punches, kicks), any intentional contact with an instrument, or any physical contact that restricts movement of a subject. The term includes, but is not limited to the use of firearms, beanbag shotgun, Conducted Electrical Weapon (CEW- e.g., Taser), ASP, chemical spray, hard empty hands, or the taking of a subject to the ground. Reportable force does not include escorting or handcuffing a subject, with no more than minimal resistance.

Intermediate Weapons: Weapons that interrupt a subject's threatening behavior so that officers may take control of the subject with less risk of injury to the subject or officer than posed by greater force applications, including but not limited to ASP batons, and Conducted Electrical Weapons (CEWs), Oleoresin Capsicum (OC) Spray and the beanbag shotguns.

Law Enforcement Officer: Includes, without limitation, all City of Cleveland police officers and any other law enforcement officers (including federal agents, state and county enforcement officers, and any other police officer of a foreign agency).

Levels of Force:

Level 1 Use of Force: Force that is reasonably likely to cause only transient pain and/or disorientation during its application as a means of gaining compliance, including pressure point compliance and joint manipulation techniques, but that is not reasonably expected to cause injury, does not result in an actual injury and does not result in a complaint of injury. It does not include escorting, touching, or handcuffing a subject with no or minimal resistance. Un-holstering a firearm and pointing it at a subject is reportable as a Level 1 use of force.

Level 2 Use of Force: Force that causes an injury, could reasonably be expected to cause an injury, or results in a complaint of an injury, but does not rise to the level of a Level 3 use of force. Level 2 includes the use of a CEW, including where a CEW is fired at a subject but misses; OC Spray application; weaponless defense techniques (e.g., elbow or closed-fist strikes, kicks, leg sweeps, and takedowns); use of an impact weapon or *beanbag shotgun*, except for a strike to the head, neck or face with an impact weapon or *beanbag shotgun*; and any canine apprehension that involves contact.

Level 3 Use of Force: Force that includes uses of deadly force; uses of force resulting in death or serious physical harm; uses of force resulting in hospital *confinement* due to a use of force injury; all neck holds; uses of force resulting in a loss of consciousness; canine bite; more than three applications of a CEW on an individual during a single interaction, regardless of the mode or duration of the application, and regardless of whether the applications are by the same or different officers; a CEW application for longer than 15 seconds, whether continuous or consecutive; and any Level 2 use of force against a handcuffed subject.

Levels of Resistance:

Active Resistance: Refers to instances in which a subject takes physical actions to defeat an officer's attempts to place the subject in custody and/or take control, but is not directed toward harming the officer. Active resistance may include but is not limited to pushing away, hiding from detection, fleeing, tensing arm muscles to avoid handcuffing or pulling away from an officer who

PAGE: 3 of 3	SUBJECT: USE OF FORCE – DEFINITIONS	NUMBER: 2.01.01
-----------------	--	--------------------

is using force in the lawful performance of their duties. Verbal statements alone do not constitute active resistance.

Aggressive Physical Resistance: Refers to instances in which a subject poses a threat of harm to the officer or others, such as when a subject attempts to attack or does attack an officer; exhibits combative behavior.

Passive Resistance: Refers to instances in which a subject does not comply with an officer's commands and is uncooperative but is nonviolent and prevents an officer from placing the subject in custody and/or taking control. Passive resistance may include but is not limited to standing stationary and not moving upon lawful direction, falling limply and refusing to move (dead weight), holding onto a fixed object, linking arms to another during a protest or demonstration, or verbally signaling an intention to avoid or prevent being taken into custody.

Necessary: Officers will use physical force only when no reasonably effective alternative appears to exist, and only then to the degree which is reasonable to effect a lawful purpose.

Neck Hold: A hold around the neck that may restrict the flow of oxygen or blood through the neck.

Reportable Force: Refers to force that officers must document and report in the manner outlined by the Use of Force Reporting Policy, GPO 2.01.05. Cleveland Division of Police uses of force are divided into three levels of response. The three levels for reporting, subsequent inquiry, and review of uses of force correspond to the level of force used and/or the outcome of the force.

Proportional: To be proportional, the level of force applied must reflect the totality of circumstances surrounding the immediate situation, including the presence of imminent danger to officers or others. Officers must rely on training, experience, and assessment of the situation to decide an appropriate level of force to be applied. Proportional force does not require officers to use the same type or amount of force as the subject. The more immediate the threat and the more likely that the threat will result in death or serious physical injury, the greater level of force that may be proportional, objectively reasonable, and necessary to counter it.

Serious Physical Harm: Any physical harm that carries a substantial risk of death; any physical harm that involves some permanent incapacity, whether partial or total, or that involves some temporary, substantial incapacity; any physical harm that involves some permanent disfigurement or that involves some temporary, serious disfigurement; any physical harm that involves acute pain of such duration as to result in substantial suffering or involves any degree of prolonged or intractable pain. (ORC 2901.01)



CLEVELAND DIVISION OF POLICE

GENERAL POLICE ORDER



EFFECTIVE DATE: January 1, 2018	CHAPTER: 2 – Legal	PAGE: 1 of 3	NUMBER: 2.01.02
SUBJECT: DE-ESCALATION			
CHIEF: <i>Calvin D. Williams, Chief</i>			

PURPOSE: To establish guidelines for officers of the Cleveland Division of Police relative to de-escalating situations in order to gain voluntary compliance and to reduce the need to use force.

POLICY: Officers have the ability to impact the direction and outcome of the situation with their decision making and employed tactics. Policing, at times, requires that an officer may need to exercise control of a violent or resisting subject, or a subject experiencing a mental or behavioral crisis. At other times, policing may require an officer to serve as a mediator between parties, or defuse a tense situation. Officers shall use de-escalation tactics and strategies when safe under the totality of the circumstances and as time and circumstances permit.

DEFINITIONS: See General Police Order 2.01.01

PROCEDURES:

I. De-escalation Tactics and Techniques

- A. De-escalation tactics and techniques are proactive actions and approaches used by officers, when feasible, to gain the voluntary compliance of subject(s) and reduce or eliminate the need to use force.
- B. Officers shall avoid taking unnecessary actions that may escalate the need to use force, (e.g. aggressive body language, proximity, harsh level of voice and tone, officer’s own stress level or excitement).
- C. When safe and feasible to do so, and before using force and/or to reduce the need for force, officers shall attempt to slow down the situation so that more time, options and resources are available for the incident to be resolved.
- D. Officers shall consider whether a subject’s lack of compliance is a deliberate attempt to resist or an inability to comprehend and/or comply based on, but not limited to the following:
 - 1. The influence of drugs and/or alcohol;
 - 2. Known or reasonably apparent mental illness, developmental disability or crisis incident;
 - 3. Known or reasonably apparent physical disability or other medical or physical condition, including visual or hearing impairment;

PAGE: 2 of 3	SUBJECT: DE-ESCALATION	NUMBER: 2.01.02
-----------------	---------------------------	--------------------

4. Limited English proficiency or other language barrier; and
 5. Perceived age of a child.
- E. When deciding which tactical options are the most appropriate to bring the situation to a safe resolution, the officer's awareness of the above factors (Paragraph I. C.) shall be weighed in light of the facts of the incident and the totality of the circumstances facing the officer.
- F. De-escalation techniques shall be used, if feasible, once officers assess any threats present at the incident. The nature and immediacy of the threat will help determine what de-escalation or other tactics an officer may use to address the threat. In determining whether and what de-escalation techniques may be appropriate, officers should also:
1. Determine whether the subject is in a mental health/behavioral crisis.
 - a. If the subject is in a mental health/behavioral crisis, officers shall call a Specialized CIT Officer to the scene. Specialized CIT officers who are dispatched to an incident involving an individual in crisis will have primary responsibility for the scene unless or until a supervisor arrives and assumes responsibility. (Refer to Crisis Intervention GPO 3.2.06).
 - b. If a supervisor has assumed responsibility for the scene involving a subject in a mental health/behavioral crisis, the supervisor will seek the input of a specialized CIT officer regarding strategies for resolving the crisis when it is reasonable for them to do so.
 - c. If the subject is not in a mental health/behavioral crisis, officers shall de-escalate in accordance with this policy.
- G. De-escalation Techniques include:
1. Proactive use of distance, cover, concealment, and time.
 - a. Separating oneself from the threat and create a safe distance to speak with subject(s). This allows officers to assess the situation and their options, bring additional resources to the scene, and develop a plan for resolving the incident without use of force;
 - b. Placing barriers between officers and an uncooperative subject;
 - c. Moving from a position that exposes officers to potential threats to a safer position;
 - d. Avoiding physical confrontation, unless immediately necessary (for example, to protect someone or to stop behavior that creates an imminent threat);

PAGE: 3 of 3	SUBJECT: DE-ESCALATION	NUMBER: 2.01.02
-----------------	---------------------------	--------------------

- e. Slowing down the pace of the incident, from the time officers receive the radio broadcast, and utilizing Division trained anxiety and stress management techniques when necessary;
 - f. Allowing time and/or opportunity for a subject(s) to regain self-control or cease struggling or resisting, when their actions do not immediately threaten the safety of officers or others;
 - g. Request additional personnel and wait, when safe and feasible to do so, for arrival of additional personnel.
2. Hearing and Listening - Demonstrate officers are listening by interacting in conversation; people have a desire to be heard and understood.
 3. Strategic communication or voice commands to de-escalate the situation
 - a. Verbalize to the subject(s), in a calm manner and normal tone of voice, all the options available to them, which officers can help with, and which would be best to end subject's crisis;
 - b. Ask questions rather than issue orders;
 - c. Advise the subject(s) of the actions that officers will take to end their crisis in the best way possible;
 - d. As a last resort, inform the subject that not following orders may result in the need to use force. When possible and appropriate, give subjects the opportunity to comply with directives.
 4. Increase officer presence, if necessary, to increase strategic options available for bringing a subject under control and/or reduce the severity of the threat.
 - a. Request additional personnel respond to the scene/subject.
 - b. Where a subject appears to be experiencing a behavioral or mental health crisis, call a Specialized CIT Officer to the scene.
 - c. Request a supervisor.
- II. Training** - Officers shall receive integrated, scenario based training at least yearly on de-escalation techniques and tactical ways to handle situations where the use of force can be avoided or the level of force minimized.



CLEVELAND DIVISION OF POLICE

GENERAL POLICE ORDER



EFFECTIVE DATE: APRIL 27, 2020	CHAPTER: 2 - Legal	PAGE: 1 of 7	NUMBER: 2.01.03
SUBJECT: USE OF FORCE - GENERAL			
CHIEF: <i>Calvin D. Williams, Chief</i>			

Substantive changes are italicized

PURPOSE: To establish guidelines for officers of the Cleveland Division of Police relative to the use of force, and to provide direction and clarity, in those instances when a subject’s actions require an appropriate use of force response.

POLICY: Consistent with the Division’s mission, including the commitment to carry out its duties with a reverence for the sanctity of human life, it is the policy of the Division to use only that force which is necessary, proportional to the level of resistance, and objectively reasonable based on the totality of circumstances confronting an officer. Officers shall also take all reasonable measures to de-escalate an incident and reduce the likelihood or level of force. Any use of force that is not necessary, proportional, and objectively reasonable and does not reflect reasonable de-escalation efforts, when safe and feasible to do so, is prohibited and inconsistent with Divisional policy.

PRINCIPLES:

I. General

- A. The use of force is regulated by state and federal law and is not left to the unregulated discretion of the officer. Use of force decisions are dictated by the actions of the resistant or combative subject, the law, Division policy, proper tactics, and training.
- B. Officers will be held accountable to Division use of force policies on-duty and off-duty.
- C. These principles apply to all uses of force, not only the use of deadly force.

II. Necessity

- A. **OFFICERS SHALL USE ONLY THE AMOUNT OF FORCE NECESSARY TO ACHIEVE A LAWFUL OBJECTIVE.**
- B. Officers shall use force only as necessary, meaning only when no reasonably effective alternative to the use of force appears to exist, and then only to the degree which is reasonable to effect the intended lawful objective.
- C. Force has a lawful objective when it is used for any of the following:
 - 1. To effect a lawful arrest or detention of a subject.
 - 2. To gain control of a combative subject.
 - 3. To prevent or terminate the commission of a crime.

PAGE: 2 of 7	SUBJECT: USE OF FORCE - GENERAL	NUMBER: 2.01.03
-----------------	------------------------------------	--------------------

4. To intervene in a suicide or self-inflicted injury.
5. To defend or protect an officer or an individual from the violent or resistant physical acts of another.

III. Proportionality

- A. **ALL FORCE SHALL BE PROPORTIONAL TO THE LEVEL OF THE SUBJECT'S RESISTANCE.**
- B. To be proportional, the level of force applied must reflect the totality of the circumstances known to the officer at the time force was applied. Generally, only the amount of force required to control the subject shall be used by the officer.

IV. Objective Reasonableness

- A. **ALL FORCE SHALL BE OBJECTIVELY REASONABLE.**
- B. Objectively reasonable force is a level of force that is appropriate when analyzed from the perspective of a reasonable officer on scene, rather than with 20/20 hindsight. Objective reasonableness takes into account, where appropriate, the fact that officers must make rapid decisions regarding the amount of force to use in tense, uncertain, and rapidly evolving situations. All uses of force are analyzed under the Fourth Amendment as guided by the United States Supreme Court, Graham v. Connor, 490 U.S. 386 (1989).
- C. Officers shall assess each incident and determine based on law, policy, training, and experience, which level of force should be used to control the situation in the safest manner for all individuals involved. Reasonable and sound judgment will dictate the force option to be deployed.
- D. The reasonableness inquiry with respect to force is an objective one, whether the officer's actions are objectively reasonable in light of the facts and circumstances confronting and reasonably known to the officer at the time of the incident. These factors include, but are not limited to the following:
 1. The severity of the crime(s).
 2. Whether the subject is actively resisting arrest or attempting to evade arrest by flight.
 3. Whether the subject poses an immediate threat to the safety of the officer(s) or others.
- E. Officers shall consider the following officer/subject factors and circumstances when choosing a force response, including for example, how the presence of one or more of these factors could impair a subject's ability to comply with officer commands or affect the nature or degree of the threat presented:

PAGE: 3 of 7	SUBJECT: USE OF FORCE - GENERAL	NUMBER: 2.01.03
-----------------	------------------------------------	--------------------

1. The influence of drugs and/or alcohol.
2. Known or reasonably apparent mental illness, developmental disability or crisis incident.
3. Known or reasonably apparent physical disability or other medical or physical condition, including visual or hearing impairment.
4. Limited English proficiency or other language barrier.
5. The time available for an officer to make decisions.
6. The availability of officers/resources to de-escalate the situation.
7. The proximity or access to weapons by the subject.
8. Differences between the following officer and subject characteristics:
 - a. Age
 - b. Gender
 - c. Body size
 - d. Skill level
 - e. Relative strength
 - f. Injury or exhaustion
9. Officer and subject position (e.g., being on the ground).
10. Officer and subject distance.
11. Officer special knowledge or training.
12. The degree to which the subject is already restrained (e.g., handcuffed, physically controlled by others, or whose mobility has been otherwise severely compromised).

F. The unreasonable use of force shall subject officers to the disciplinary process, possible criminal prosecution, and/or possible civil liability.

V. De-escalation

A. **OFFICERS SHALL USE DE-ESCALATION TECHNIQUES WHEN IT IS SAFE AND FEASIBLE TO DO SO UNDER THE TOTALITY OF THE CIRCUMSTANCES** (Refer to GPO 2.01.02 De-escalation).

PAGE: 4 of 7	SUBJECT: USE OF FORCE - GENERAL	NUMBER: 2.01.03
-----------------	------------------------------------	--------------------

- B. Officers shall continue to assess/evaluate whether the force response being deployed remains proportional to the changing nature of the threat or circumstances being encountered, while still achieving the lawful objective. Officers shall reduce the level of force applied as the nature of the threat diminishes.

PROCEDURES:

VI. General

- A. When feasible, officers shall attempt to identify themselves as police officers and make an attempt to advise the subject(s) of their intent to detain, arrest, or search before using force.
- B. When feasible, and to do so would not increase the danger to officers or others, officers shall issue a verbal warning to submit to their authority prior to the use of force.
- C. Officers shall take all reasonable steps under the circumstances, before and during any use of force, to avoid unnecessary risk to bystanders, victims, hostages, and other involved civilians, as well as other officers and emergency personnel.
- D. Officers shall consider their surroundings when unholstering or before discharging their firearm and shall avoid unnecessary risk to bystanders, victims, and other officers.
- E. With the exception of pointing a firearm at an individual, officers shall notify a supervisor to respond to the scene of any reportable use of force incident. When officers point their firearm at an individual they shall notify a supervisor, and the officers shall complete the proper use of force entry.
- F. Officers shall promptly, accurately, and thoroughly document the reasons for and types of force used.

VII. Deadly Force: When Authorized - Tennessee v. Garner, 471 U.S. 1 (1985)

- A. All of the provisions of this policy, including the Division's commitment to recognizing the sanctity of human life and requirements that officers use only the degree of force necessary under the circumstances governing force, also govern deadly force (See Principles).
- B. Deadly force may be used only if a subject, through their own actions, poses an imminent threat of death or serious physical harm to an officer or another.
- C. Deadly force may be used to prevent the escape of a fleeing subject only when an officer would reasonably believe under the circumstances that it is necessary, and when feasible, some warning has been given, and there is probable cause to believe that:
 - 1. The subject is in the process of committing or has committed a violent felony involving the infliction or threatened infliction of serious physical harm or death, and the subject would pose a continuing imminent threat of serious physical harm, either to the officer or others; OR

PAGE: 5 of 7	SUBJECT: USE OF FORCE - GENERAL	NUMBER: 2.01.03
-----------------	------------------------------------	--------------------

2. The escape of the subject would pose an imminent danger of death or serious physical harm to the officer or to another if the subject is not apprehended without delay.

VIII. Use of Force: When Prohibited

A. Consistent with the principles of necessity, proportionality, objective reasonableness, and de-escalation, **officers shall not:**

1. Use force to subdue a subject who is not suspected of any criminal conduct, other than to protect an officer's or another person's safety.
2. Use retaliatory force which includes, but is not limited to, force in excess of what is objectively reasonable to prevent an escape, force to punish an individual for fleeing or otherwise resisting arrest, force used to punish an individual for disrespecting officers, and other such circumstances.
3. Use force against a subject who only verbally confronts officers and is not involved in criminal conduct.
4. Use force against a subject who is handcuffed or otherwise restrained, unless it is objectively reasonable and necessary under the circumstances to stop an assault, escape, or as necessary to fulfill other law enforcement objectives.
5. Unholster and display or unholster and point a firearm unless the circumstances surrounding the incident create an objectively reasonable belief that the situation may escalate to the point at which deadly force would be authorized.
6. Use force to overcome passive resistance, except where it is necessary, proportional, and objectively reasonable to achieve a legitimate law enforcement objective.
7. Use force against those who are only exercising their First Amendment rights. Physically moving a subject is permitted when it is necessary and objectively reasonable for the safety of that individual or the public. It shall be done with sufficient personnel so as not to endanger the subject or the officers and will not be considered a reportable use of force unless it meets the criteria of a Level 1, Level 2, or Level 3 use of force.
8. Carry weapons that are not authorized or approved by the Division.
9. Use a firearm as an impact weapon.
10. Fire warning shots.
11. Use deadly force solely to protect property or solely to effect an arrest.
12. Use neck holds.

PAGE: 6 of 7	SUBJECT: USE OF FORCE - GENERAL	NUMBER: 2.01.03
-----------------	------------------------------------	--------------------

13. Discharge a firearm from or at a moving vehicle, unless the use of deadly force is justified by something other than the threat of the moving vehicle (Refer to GPO 3.2.02 Vehicle Pursuits).
14. Reach into or place themselves in the path of a vehicle. Officers shall move out of the path of a moving vehicle (Refer to GPO 3.2.02 Vehicle Pursuits).
15. Discharge a firearm at a threat that is not verified and visible.
16. Use head strikes with hard objects.

B. In rare and exceptional situations where, under the facts and circumstances confronting the officer, a reasonable officer would believe that (a) the use of deadly force would be objectively reasonable, necessary, and proportional according to this policy, and (b) the subject's actions constitute an immediate danger and grave threat to the officer or others, and (c) no other force options, techniques, tactics, or choices consistent with the Division's policy are available, it may be necessary for an officer to take extraordinary or unanticipated actions in order to overcome the threat.

1. In these rare and exceptional situations, officers must specifically articulate and justify with particularity the specific tactic(s) or action(s) employed and the reasons why their actions met each of the criteria (a), (b), and (c) set forth above.
2. The officer's actions, including all actions preceding the use of deadly force, shall be subject to strict review.

IX. Duty to Intervene

- A. Officers who are present at the scene of a police use of force are obligated to ensure that the use of force complies with the requirements of the law, Division rules, policy, and training.
- B. Each officer at the scene of a use of force incident has a duty to intervene by taking all reasonable actions to stop any use of force that is perceived to be unauthorized by this policy.
- C. Officers witnessing suspected unreasonable force shall factor into their response their ability to de-escalate the use of force. The officer's response may range from physical intervention, to voice commands, to appropriate after-action notification. If reasonably able to do so, the officer shall:
 1. Physically intervene to stop the objectively unreasonable force.
 2. Take protective custody of the subject being subjected to the apparent unreasonable force.
 3. Ensure that medical care is provided as needed.
 4. Report the suspected unreasonable use of force to the next non-involved supervisor

PAGE: 7 of 7	SUBJECT: USE OF FORCE - GENERAL	NUMBER: 2.01.03
-----------------	------------------------------------	--------------------

in their chain of command, document the same in their duty report *and/or Mobile Computer Aided Dispatch (MCAD) entry*, and complete a Form-1 detailing the use of force and surrounding circumstances as soon as safe and practical, before the end of the tour of duty.

X. Duty to Provide Medical Attention

- A. Immediately following any use of force and when the scene is secure, officers, and upon their arrival, supervisors, shall inspect and observe the subject for injury or complaints of pain resulting directly or indirectly from the use of force.
- B. If needed, officers and supervisors shall immediately obtain any necessary medical care while providing emergency first aid until professional medical care providers arrive.
- C. Officers shall immediately request Emergency Medical Services (EMS) to respond for the following use of force applications regardless of visible injury or complaint of injury:
 - 1. Discharge of a firearm that strikes a subject.
 - 2. Impact of subject's head against any hard, fixed object.
 - 3. With the exception of pointing a firearm at an individual, any reportable use of force on subjects who are reasonably believed or known to be pregnant, children, elderly, physically or medically frail, or disabled.
 - 4. Refer to GPO 2.01.04 Use of Force - Intermediate Weapons for additional situations requiring a request for EMS.
- D. Whenever EMS is requested, officers shall be sure the scene is tactically safe, or when tactically unsafe for EMS response, as soon as practical, but without unnecessary delay, the subject shall be transported to a safe location for treatment.
- E. Officers shall closely monitor subjects who are taken into custody if injured, exhibiting physical distress, complaining of pain, or have been rendered unconscious.

XI. Training - Officers shall be trained and tested at least yearly on the laws and Division policies regarding the use of force.

THIS ORDER SUPERSEDES ANY PREVIOUSLY ISSUED DIRECTIVE OR POLICY FOR THIS SUBJECT AND WILL REMAIN EFFECTIVE UNTIL RESCINDED OR SUPERSEDED.



CLEVELAND DIVISION OF POLICE

GENERAL POLICE ORDER



EFFECTIVE DATE: July 1, 2019	CHAPTER: 2 - Legal	PAGE: 1 of 10	NUMBER: 2.01.04
SUBJECT: USE OF FORCE – INTERMEDIATE WEAPONS			
CHIEF: <i>Calvin D. Williams, Chief</i>			

Substantive changes are italicized

PURPOSE: To establish guidelines for officers of the Cleveland Division of Police relative to the use of force when deploying intermediate weapons, while providing direction and clarity, in those instances when a subject’s actions require a use of force response.

POLICY: Intermediate weapons are used to interrupt a subject’s threatening behavior so that officers may take control of the subject with less risk of injury to the subject or officer than posed by greater force applications. Intermediate weapons may be used when objectively reasonable, necessary, proportional, and permitted under this policy.

PROCEDURES:

I. General

A. Intermediate Weapons: Requirements to Carry and Qualify

1. Officers shall carry only weapons that are issued by the Division.
2. Officers are required to successfully complete annual mandatory training which includes scenario-based training, meet the Division’s proficiency standards, and requalify, as set forth by the Training Section, in order to be issued and carry intermediate weapons on duty and while engaged in secondary employment. (Refer to GPO 1.1.35, *Police Officer Training Standards*)
3. Uniformed officers shall carry the Conducted Electrical Weapon (CEW) if qualified, and a second intermediate weapon: ASP baton or Oleoresin Capsicum (OC) Spray. If not CEW qualified, officers shall carry both approved intermediate weapons: ASP baton and OC Spray. Officers may elect to carry all three intermediate weapons.
4. All intermediate weapons shall be worn only on the officer’s duty belt.
5. Officers and supervisors assigned to specialized units may carry intermediate weapons as dictated by their responsibilities. The Officer-in-Charge of each Unit will provide guidance and direction in this area to Unit members according to the Unit’s manual.

PAGE: 2 of 10	SUBJECT: USE OF FORCE – INTERMEDIATE WEAPONS	NUMBER: 2.01.04
------------------	---	--------------------

B. Intermediate Weapons: When Authorized

1. Intermediate weapons shall be used in accordance with the Division's policies including those related to GPO 2.01.03, Use of Force - General, De-escalation training.
2. Prior to the use of any approved intermediate weapon, when feasible and appropriate, the officer shall communicate to the subject, other officers, and bystanders that the use of the weapon is imminent and allow the subject an opportunity to comply. An opportunity to comply typically means a reasonable amount of time to comply.
3. Officers shall be mindful that in some instances a subject's disability or condition may limit or restrict their ability to comply with an officer's direction (Refer to GPO 2.01.03, Use of Force - General).
4. Before using intermediate weapons on children and juveniles, officers must consider the following factors: body mass, physical build, perceived age, and emotional condition. Officers shall use appropriate responses for children and juveniles at all times.

C. Intermediate Weapons: When Prohibited

1. Officers shall not use intermediate weapons on subjects who are passively resisting.
2. Officers shall not use intermediate weapons to prevent the destruction of evidence.
3. Officers shall not use intermediate weapons against small children, the elderly, individuals who are visibly frail, or women visibly or known to be pregnant, except where deadly force is authorized.
4. Officers shall not use intermediate weapons on subjects who are handcuffed or otherwise restrained unless the subject is displaying aggressive physical resistance AND lesser means would be ineffective or have been tried and failed.
5. Officers shall not use intermediate weapons or objects to prod individuals.
6. Officers shall not use intermediate weapons on subjects who are under control or complying with police direction.

D. Intermediate Weapons: Reporting - Officers shall report the use of intermediate weapons in accordance with GPO 2.01.05, Use of Force - Reporting.

II. ASP Baton/Riot Baton/Impact Weapons

A. ASP Baton/Riot Baton/Impact Weapons: Guidelines

1. Officers are authorized to deploy the ASP baton:

PAGE: 3 of 10	SUBJECT: USE OF FORCE – INTERMEDIATE WEAPONS	NUMBER: 2.01.04
------------------	---	--------------------

- a. *Where grounds for an arrest or detention are present and the subject is actively or aggressively resisting and lesser means would be ineffective; or*
 - b. *Where such force is objectively reasonable, necessary, and proportional to protect the officer, the subject, or another party from immediate physical harm, and lesser means would be ineffective.*
 2. Officers shall consider each separate ASP baton strike as a separate use of force that officers must individually justify and report as objectively reasonable, necessary, and proportional.
 3. The use of riot batons is authorized only during field force deployments.
- B. ASP Baton/Riot Baton/Impact Weapons: When Prohibited**
1. Officers shall not intentionally target ASP baton strikes to sensitive tissue areas, such as the head, neck, spine or genitalia. Baton strikes to the head and neck constitute deadly force. Preferred target areas are the arms, legs, and torso.
 2. Impact weapons other than the ASP Baton, or in field force deployments the riot baton, are prohibited by the Division unless extreme circumstances require their use to gain compliance from aggressively resistant subjects.
 3. Officers shall not use head strikes with hard objects, except where deadly force is justified. Officers shall be trained that a strike to the head with any hard object could result in death.
 4. Officers shall not use their firearm as an impact weapon, due to the possibility of unintentional discharge and/or the possibility that it could result in the death of the officer, the subject, or others.
- C. Medical Attention after the Use of the ASP Baton/Riot Baton/Impact Weapons - Officers shall request Emergency Medical Services (EMS) after striking a subject to the head, neck, spine or genitalia with an ASP baton or any other impact weapon for an examination. Refer also to GPO 2.01.03, Use of Force - General, Section V. C. (Duty to Provide Medical Attention) for additional requirements to provide medical attention.**

III. Oleoresin Capsicum (OC) Spray

A. OC Spray: Guidelines

1. Officers are authorized to deploy OC Spray only:
 - a. *Where grounds for an arrest or detention are present and the subject is actively or aggressively resisting and lesser means would be ineffective; or*

PAGE: 4 of 10	SUBJECT: USE OF FORCE – INTERMEDIATE WEAPONS	NUMBER: 2.01.04
------------------	---	--------------------

- b. *Where such force is objectively reasonable, necessary, and proportional to protect the officer, the subject, or another party from immediate physical harm, and lesser means would be ineffective.*
 - c. For crowd dispersal or protection and other means would be more intrusive or less effective.
 - 2. Officers shall be aware of the risks of positional asphyxia and shall use restraint techniques that do not impair the subject's respiration following an OC Spray application.
 - 3. Officers shall be aware of the risks of using OC spray in confined or enclosed environments.
 - 4. Officers shall direct OC Spray at the specific subject(s) who are posing a threat, attempting to minimize exposure to non-targeted subjects or parties.
 - 5. Officers shall consider each one-second application as a separate use of force that the officer shall individually justify and report as objectively reasonable, necessary, and proportional.
 - 6. Officers shall discontinue use if a subject does not comply after two one-second bursts of OC Spray that successfully contacts the target.
 - 7. The use of OC Spray on a dangerous animal is permissible to deter an attack or to prevent injury to persons present. Documentation shall be provided in the related incident report.
- B. OC Spray: When Prohibited - Officers shall not use OC Spray on subjects with a known respiratory condition unless it is an extreme and articulable situation.
- C. Medical Attention After the Use of OC Spray
- 1. As soon as practicable, but no later than 20 minutes after establishing control of the scene, the officer shall make a reasonable effort to relieve the subject's OC Spray discomfort by washing OC Spray from the subject's eyes with cool water. If the subject was exposed in a confined space, officers will remove the subject as soon as possible from the contaminated area and expose the individual to fresh air.
 - 2. Officers shall monitor exposed subjects for changes in their condition while in police custody and request medical attention as needed.
 - 3. Officers shall immediately request that EMS respond for any of the following circumstances:
 - a. The subject is experiencing symptoms (other than mild) which last beyond 45 minutes.

PAGE: 5 of 10	SUBJECT: USE OF FORCE – INTERMEDIATE WEAPONS	NUMBER: 2.01.04
------------------	---	--------------------

- b. The subject has or indicates that they have difficulty breathing or loses consciousness.
- c. The subject indicates they have a pre-existing condition (such as asthma, emphysema, bronchitis, or heart ailment) that may be aggravated by chemical spray.
- d. The officer believes that the subject needs medical attention whether the subject requests it or not.
- e. The officer is made aware that the OC Spray was used on a child or elderly, pregnant, physically disabled or mentally ill subject.

IV. Conducted Electrical Weapon (CEW)

A. CEW Guidelines

- 1. The CEW **shall** only be used in either of the following situations:
 - a. Where grounds for arrest or detention are present and the subject is actively or aggressively resisting, and lesser means would be ineffective; or
 - b. Where such force is objectively reasonable, necessary, and proportional to protect the officer, the subject, or another party from immediate physical harm, and lesser means would be ineffective or have been tried and failed.
- 2. Officers **shall**:
 - a. Carry the CEW in a Division issued holster, on the opposite side of the firearm, to reduce the chances of accidentally drawing and/or firing a firearm.
 - b. Deploy the CEW at the preferred target zones which include the lower center mass of the body on the front of the body and below the neckline of the back upper body. When encountering subjects wearing heavy or loose clothing on the upper body, officers may consider the legs as targets.
 - c. Determine the reasonableness of the CEW use and probe placement based on all the relevant circumstances, including the subject's apparent age, size, physical, and mental condition and the feasibility of lesser force options.
 - d. Limit each CEW cycle to 5 seconds.
 - e. Use the minimum number of 5-second CEW cycles necessary to gain control of the subject.
 - f. Consider each CEW application (i.e., 5-second cycle) as a separate use of force that officers shall individually justify and report as objectively reasonable, necessary, and proportional.

PAGE: 6 of 10	SUBJECT: USE OF FORCE – INTERMEDIATE WEAPONS	NUMBER: 2.01.04
------------------	---	--------------------

- g. Consider that exposure to the CEW for longer than 15 seconds (whether due to multiple applications or continuous cycling) may increase the risk of death or serious injury.
 - h. Immediately after a CEW application, attempt to handcuff or restrain the subject if compliance has been gained and it is tactically safe to do so.
 - i. Reevaluate the situation after each CEW application to determine if subsequent cycles are reasonable, considering a subject may not be able to respond to commands during or immediately following a CEW application. Alternatives to a CEW include force techniques of the same or lesser level and are not, therefore, limited to the application of higher-level force.
 - j. If after three CEW applications the subject has not become compliant, even temporarily, the officer shall assume that the CEW is ineffective and shall reassess and seek to transition to alternative control measures.
 - k. Use caution when dealing with exhausted subjects exhibiting symptoms of physical or mental distress and be aware that certain subjects may be at a heightened risk for serious physical injury or death when subjected to CEW applications.
 - l. Avoid using restraint techniques that impair a subject's respiration following a CEW application.
 - m. Consider a CEW in the hands of a subject a deadly weapon when no other officer is present to provide deadly force cover. If multiple officers are present, the CEW in the hands of a subject is not a deadly weapon unless it can be clearly articulated that an officer or innocent party was in imminent danger of serious physical injury or death due to the subject's possession of a CEW.
3. If an initial CEW shot does not make contact or is ineffective, the same or another officer may attempt additional shots as needed or practical in order to make successful contact on a subject.
 4. The use of the CEW on a dangerous animal is permissible to deter an attack or to prevent injury to persons present. Documentation shall be provided in the related incident report.

B. CEW: When Prohibited

1. Officers **shall not** use the CEW:
 - a. In drive-stun mode solely for pain compliance. The CEW is only to be used in drive stun mode to supplement the probe mode in order to complete the incapacitation circuit or as a countermeasure to gain separation between officers and the subject so that officers can consider another force option.

PAGE: 7 of 10	SUBJECT: USE OF FORCE – INTERMEDIATE WEAPONS	NUMBER: 2.01.04
------------------	---	--------------------

- b. On fleeing subjects who do not pose a threat of physical harm to the officer, bystanders, or themselves.
 - c. If the subject represents a lethal threat unless a second officer is present and prepared to deploy deadly force.
- 2. Officers shall not intentionally target the CEW at a subject in sensitive tissue areas, such as the head, neck, or genitalia.
- 3. Except where deadly force is authorized, officers shall not use the CEW in situations where:
 - a. A deployment may cause serious physical injury or death from situational hazards, including but not limited to: falling, losing control of a moving vehicle, or becoming ignited from the presence of potentially explosive or flammable materials or substances, including OC Spray.
 - b. The subject has obviously low body mass or is in apparent medical crisis.
- 4. Officers shall not intentionally activate more than one CEW at a time against a subject.
- 5. An officer shall not hold both a CEW and a firearm at the same time.

C. CEW Exceptional Circumstances

- 1. Absent rare and exceptional circumstances, officers shall not exceed three 5-second CEW cycles in total on any one subject during a single incident unless the following apply:
 - a. The officer reasonably believes that the initial CEW applications have been effective in gaining the subject's temporary compliance, but the subject continues to actively or aggressively resist;
 - b. The subject's continuing non-compliance presents a threat of imminent physical harm to the officer or others;
 - c. No other force technique, tactic or choice consistent with Division policy would be effective; and
 - d. The use of the CEW beyond a third cycle will prevent resorting to deadly force options.
- 2. Each CEW application shall be independently justifiable and shall be weighed against other force options.
- 3. More than three applications of a CEW on an individual during a single interaction, regardless of the mode or duration of the application, and regardless of whether the

applications are by the same or different officers, or a CEW application for longer than 15 seconds, whether continuous or consecutive, shall be reported and investigated as a Level 3 use of force.

D. Medical Attention After the Use of the CEW

1. After deployment of the CEW, officers **shall**:
 - a. Call EMS to the scene without unnecessary delay to evaluate a subject who has been exposed to a CEW shock. EMS personnel or medical personnel at a medical facility shall remove probes penetrating sensitive areas (e.g., head, face, neck, groin, or breast areas). While it is preferred that medical personnel remove penetrating probes, a CEW-qualified officer may remove probes penetrating non-sensitive areas (e.g., buttocks, thighs) if it is reasonable to do so.
 - b. Inform medical personnel of all subjects who have been subjected to multiple CEW applications, including prolonged applications (more than 15 seconds); or who appear to be under the influence of drugs or exhibiting symptoms associated with physical or mental distress; or who were kept in prone restraints after CEW use.
 - c. Request that EMS transport the subjects to the hospital in any of the following circumstances:
 1. The officer is made aware that the CEW was deployed on a child or elderly, pregnant, physically disabled or mentally ill subject.
 2. The subject experiences or complains of difficulty breathing, chest pains, or loss of consciousness.
 3. The officer believes the subject requires medical attention (whether or not the subject requests attention).
 4. The officer becomes aware afterward of a medical condition (e.g., epilepsy or heart ailment) that a CEW may aggravate.
 - d. Monitor the subject for signs of medical distress for as long as the subject is in Division custody, paying particular attention to indicators of positional asphyxia.
 - e. Notify the Corrections Officer when booking a prisoner who was exposed to a CEW shock. The same notification shall be made when transporting or transferring the prisoner to any entity outside of the Division.
2. In extreme circumstances when EMS is unable to transport or is delayed, and if the officer reasonably believes medical attention is necessary without delay, the officer may transport the subject to the hospital using the zone car.

PAGE: 9 of 10	SUBJECT: USE OF FORCE – INTERMEDIATE WEAPONS	NUMBER: 2.01.04
------------------	---	--------------------

V. Beanbag Shotgun

A. Beanbag Shotgun: Guidelines

1. The beanbag shotgun shall only be deployed by qualified officers (Supervisors/SWAT officers). Beanbag shotgun inspections will be conducted on an annual basis to ensure that all are operable and any necessary maintenance or repairs are performed.
2. The beanbag shotgun may be deployed when a subject presents an imminent risk of serious physical harm to an officer or others, de-escalation and other force options have proven ineffective, and the subject is within a safe range of the beanbag shotgun.
3. The optimal range for effective deployment while minimizing risk is 21 to 50 feet.
 - a. Deployment at less than 21 feet increases the risk of serious injury or death.
 - b. At over 50 feet, the effect and accuracy of the beanbag shotgun are diminished to the point that this option will not achieve its purpose.
4. If the subject represents a lethal threat, a second officer prepared to deploy deadly force shall be present when deploying a beanbag shotgun.
5. All bean bag shotguns *are* clearly marked *with a yellow stock and fore-end*, so as to make them instantly distinguishable from a weapon firing live rounds.
6. Officers **shall** request via Communication Control Section (CCS) a beanbag shotgun equipped supervisor respond to the scene when circumstances exist that meet the guidelines for deployment.
7. Supervisors **shall**:
 - a. Use equivalent standard precautions as used with all firearms per GPO 2.01.03, Use of Force - General, in order to protect others from the harm of a misdirected beanbag round.
 - b. *Avoid the body's chest, head, neck, and groin.*
 - c. Consider each discharged beanbag round as a separate use of force that officers shall individually justify and report as objectively reasonable, necessary, and proportional.

B. Beanbag Shotgun: When Prohibited

1. Officers **shall not**:

PAGE: 10 of 10	SUBJECT: USE OF FORCE – INTERMEDIATE WEAPONS	NUMBER: 2.01.04
-------------------	---	--------------------

- a. Subject themselves or others to undue risk while waiting for the arrival of a supervisor with a beanbag shotgun. The situation must be continually assessed, and other appropriate action must be taken if the risk to self or others demands immediate attention.

2. Supervisors **shall not**:

- a. Use the beanbag shotgun as a substitute for notifying the SWAT Unit when circumstances warrant that unit's deployment.
- b. Fire more than two beanbag shotguns simultaneously. In the event that four rounds have proven to be ineffective, officers shall consider the beanbag shotgun ineffective and exercise other options.

- C. Medical Attention After the Use of a Beanbag Shotgun

1. Officers **shall**:

- a. Notify EMS via CCS to respond and convey subject(s) struck by a beanbag round, to the hospital for medical treatment/evaluation.
- b. When booking a prisoner who was struck by a beanbag round notify the Corrections Officer that the prisoner was struck with a beanbag round. The same notification shall be made when transporting or transferring the prisoner to any entity outside of the Division.

VI. Intermediate Weapons Approved for Use by the SWAT Unit - Intermediate weapons approved for usage by the SWAT Unit shall be used in accordance with the Division Use of Force policies and the SWAT Unit manual.



CLEVELAND DIVISION OF POLICE

GENERAL POLICE ORDER



EFFECTIVE DATE: July 1, 2019	CHAPTER: 2 – Legal	PAGE: 1 of 6	NUMBER: 2.01.05
SUBJECT: USE OF FORCE – REPORTING			
CHIEF: <i>Calvin D. Williams, Chief</i>			

Substantive changes are in italics

PURPOSE: To establish guidelines for the reporting of all use of force responses and for documenting objective reasonableness, necessity, and proportionality after a use of force response.

POLICY: Officers shall notify their supervisor when they have used force, except for *de minimis* force. Officers shall clearly, thoroughly and properly report use of force incidents. The necessity for each application of force shall be documented, identifying the uniqueness of each situation and justifying every force response.

PROCEDURES:

I. Use of Force Notification Guidelines

- A. Officers who use or witness force shall contact the Communication Control Section (CCS) and request that their supervisor respond to the scene as soon as practical following any use of force, except for *de minimis* force. (Refer to GPO 2.01.01, Use of Force - Definitions).
- B. An officer who becomes aware of an allegation of unreported, unreasonable, unnecessary or disproportionate force by another officer shall immediately notify his or her supervisor of that force or allegation. (Refer to GPO 1.07.05, Internal Complaints of Misconduct and GPO 1.07.07, Retaliation).

II. Use of Force Reporting General Guidelines

- A. Officers shall report all uses of force except for *de minimis* force.
- B. All use of force reports shall be completed with sufficient detail for supervisors and the Division to understand the totality of the circumstances, events, and actions of the officer, subject, and other involved individuals during a use of force incident. The use of force report must also permit the Division to conduct a thorough and appropriate investigation and review of the force incident. The Division shall provide regular training (including roll call, in-service, or electronic-based instruction) on reporting writing.
- C. Officers shall not use conclusory statements, “boilerplate” or “canned” language (e.g., furtive movement, fighting stance), without supporting details that are well articulated in the required reports. When possible, and to ensure clarity, officers will minimize the use of unnecessary acronyms or jargons.
- D. Every application of force by an officer is classified according to the following levels:

PAGE: 2 of 6	SUBJECT: USE OF FORCE – REPORTING	NUMBER: 2.01.05
-----------------	--------------------------------------	--------------------

1. **Level 1 Use of Force:** Force that is reasonably likely to cause only transient pain and/or disorientation during its application as a means of gaining compliance, including pressure point compliance and joint manipulation techniques, but that is not reasonably expected to cause injury, does not result in an actual injury and does not result in a complaint of injury. It does not include escorting, touching, or handcuffing a subject with no or minimal resistance. Un-holstering a firearm and pointing it at a subject is reportable as a Level 1 use of force.
 2. **Level 2 Use of Force:** Force that causes an injury, could reasonably be expected to cause an injury, or results in a complaint of an injury, but does not rise to the level of a Level 3 use of force. Level 2 includes the use of a CEW, including where a CEW is fired at a subject but misses; OC Spray application; weaponless defense techniques (e.g., elbow or closed-fist strikes, kicks, leg sweeps, and takedowns); use of an impact weapon *or beanbag shotgun*, except for a strike to the head, neck or face with an impact weapon *or beanbag shotgun*; and any canine apprehension that involves contact.
 3. **Level 3 Use of Force:** Force that includes uses of deadly force; uses of force resulting in death or serious physical harm; uses of force resulting in hospital *confinement* due to a use of force injury; all neck holds; uses of force resulting in a loss of consciousness; canine bite; more than three applications of a CEW on an individual during a single interaction, regardless of the mode or duration of the application, and regardless of whether the applications are by the same or different officers, a CEW application for longer than 15 seconds, whether continuous or consecutive; and any Level 2 use of force against a handcuffed subject.
- E. Officers shall report uses of force in accordance with the reporting requirements of the highest level of force used during the incident. (For example, if an officer uses both Level 1 and Level 2 force during an incident, the incident is classified as a Level 2 force for reporting and review purposes).
- F. All officer use of force reports will be evaluated by the *reviewing/investigating* supervisor, chain of command, and/or department's Force Review Board. (Refer to GPO 2.01.06, Supervisory Reviews and Investigations)

III. Involved Officer Reporting Requirements

- A. Officers Using Level 1 and Level 2 Force shall:
1. By the end of their tour of duty, complete *and forward to the reviewing/investigating supervisor*, an individual use of force entry in the use of force tracking software, providing a detailed account of the incident from the officer's perspective and including all of the following information:
 - a. The reason for the initial police presence

PAGE: 3 of 6	SUBJECT: USE OF FORCE – REPORTING	NUMBER: 2.01.05
-----------------	--------------------------------------	--------------------

- b. A specific description of the acts that preceded the use of force, to include attempts to de-escalate
 - c. The level of resistance encountered
 - d. A complete and accurate description of every type of force used or observed
- B. Officer Using Level 3 Force shall:
- 1. By the end of their tour of duty, an individual use of force entry shall be completed as directed by the Officer-in-Charge of FIT. (Refer to GPO 2.01.07, Force Investigation Team)
 - 2. Comply with all additional directives from the Officer-in-Charge of FIT. (Refer to GPO 2.01.07, Force Investigation Team)

IV. Witness Reporting

- A. Officers Witnessing or Present During a Use of Force shall:
- 1. By the end of their tour of duty, complete *and forward to the reviewing/investigating supervisor, a Witness Statement Form (Attachment A)* providing a detailed account of the incident from the officer's perspective and including all of the following information:
 - a. The reason for the witnessing officer's police presence.
 - b. A specific description of the observed acts that preceded the use of force, to include any observed attempts to de-escalate.
 - c. Level of resistance observed; and
 - d. A complete and accurate description of every type of force observed.
 - 2. Submit the *Witness Statement Form* to the *reviewing/investigating supervisor or Officer-in-Charge of FIT* for review/signature *and attach the statement to the use of force entry.*
- B. Officers Witnessing Level 3 Force - In addition to completing a *Witness Statement Form* as described in IV, A, 1 (a – d), officers shall comply with all directives from the officer-in-charge of FIT. (Refer to GPO 2.01.07, Force Investigation Team)
- C. Citizens and Non-Division Law Enforcement Officers
- 1. Citizens and non-division law enforcement officers who witness force and are unable or unwilling to give a video recorded statement may make a written statement on a *Witness Statement Form (Attachment A)*.

PAGE: 4 of 6	SUBJECT: USE OF FORCE – REPORTING	NUMBER: 2.01.05
-----------------	--------------------------------------	--------------------

2. The Witness Statement Form will then be submitted to the reviewing supervisor.

V. Additional Reporting Requirements

- A. Officers deploying their CEW shall clearly articulate in their use of force entry justification for the following:
 1. Each CEW cycle of any length used on a subject or attempted on a subject.
 2. Use of the CEW in drive stun mode.
 3. Each CEW cycle in excess of three 5-second CEW cycles in total on any one subject during a single incident.
 4. Continuous cycling of the CEW beyond 5 seconds.
 5. Use of the CEW on a fleeing subject.
 6. CEW application by more than one officer.
- B. Deployment of a Canine (Refer to GPO 2.01.01, Use of Force - Definitions, GPO 2.01.06, Supervisory Reviews and Investigations, and the CDP Canine Unit Manual)
 1. Other than during training, if a canine deployment does not involve contact, the canine officer shall document the incident using the canine management software program;
 2. Deployment of a canine that involves physical contact shall be reported as a Level 2 use of force; and
 3. A canine bite shall be reported as a Level 3 use of force.
- C. Pointing of a Firearm
 1. Un-holstering a firearm or un-holstering and keeping the firearm at the low ready position, high ready position, or “SUL” position, without pointing it at an individual, is not a use of force. *Un-holstering a firearm is subject to the data collection process and shall be included in the officer’s disposition when clearing an assignment using the Mobile Computer Aided Dispatch System or by notifying CCS.*
 2. Un-holstering and pointing a firearm at a subject is considered a Level 1 reportable use of force. The following are exceptions to this reporting requirement:

PAGE: 5 of 6	SUBJECT: USE OF FORCE – REPORTING	NUMBER: 2.01.05
-----------------	--------------------------------------	--------------------

- a. SWAT Unit officers are not required to report the pointing of a firearm at a subject as a use of force during the execution of SWAT Unit duties;
- b. Officers who are deputized and assigned to a Federal Task Force are not required to report the pointing of a firearm at a subject as a use of force when conducting task force operations during which a supervisor is present. The task force supervisor shall forward any reports or forms regarding any such incidents to the commander in their chain of command.
- c. Officers assigned to the Gang Impact, Narcotics, Homicide, Sex Crimes, Domestic Violence, and Financial Crimes Units shall not be required to report the pointing of a firearm at a subject as a use of force if done solely while entering and securing a building in connection with the execution of an arrest or search warrant and a supervisor prepares a report detailing the incident provided to the commander in their chain of command.
- d. These exceptions shall apply to uniformed officers assigned to duties with all of the above listed exempt units while performing duties assigned by the supervisor during the execution of the warrant(s).

D. Off-Duty Police Action Involving a Use of Force Outside the City of Cleveland

- 1. When safely able to do so, the officer shall immediately notify CCS of the incident and when the member is scheduled or expected to return to duty. CCS shall inform the member's commander.
- 2. Upon return to duty, the officer shall:
 - a. Notify their immediate supervisor of the incident.
 - b. Complete a use of force database entry. The use of force entry shall contain the following information about the incident: date, time, location, and jurisdiction. No details of the incident are to be included in the use of force entry; the entries are for tracking and documentation only.
 - c. Obtain a copy of the incident report from the reporting agency.
- 3. Provide all the materials described here to their immediate supervisor to be routed via the tracking software, to the Internal Affairs Unit. (Refer to GPO 2.01.06, Supervisory Reviews and Investigations).

VI. Failure to Report Use of Force

PAGE: 6 of 6	SUBJECT: USE OF FORCE – REPORTING	NUMBER: 2.01.05
-----------------	--------------------------------------	--------------------

- A. Officers shall be subject to the disciplinary process, up to and including termination, for material (significant) omissions or misrepresentations in their Use of Force Reports, regardless of whether the force was objectively reasonable, necessary and proportional.
- B. Officers who use or observe force and fail to report it shall be subject to the disciplinary process, up to and including termination, regardless of whether the force was objectively reasonable, necessary and proportional.

VII. Heightened Responsibilities for Reporting Exceptional Uses of Force

- A. In the rare and exceptional circumstances that officers use force that would otherwise be prohibited by Division policy, they must justify the use of force by articulating the specific facts that led to such a use of force. Officers must describe, in detail, the objective reasonableness, necessity, and proportionality of the force that was used, the actions of the subject that constituted immediate danger and grave threat to the officers or others, the officer's efforts to de-escalate the encounter, why the officer believed that no other force options, techniques, tactics or choices consistent with Division policy were available, and how rapidly the officer was able to return to compliance with Division policies.
- B. Failure to adequately document and explain the facts underlying any use of force that conflicts with Division policies may subject the officer to the disciplinary process, possible criminal prosecution, and /or possible civil liability.



CLEVELAND DIVISION OF POLICE

GENERAL POLICE ORDER



EFFECTIVE DATE: JANUARY 27, 2021	CHAPTER: 2 - Legal	PAGE: 1 of 7	NUMBER: 2.01.06
SUBJECT: USE OF FORCE - SUPERVISORY REVIEWS AND INVESTIGATIONS			
CHIEF: <i>Calvin D. Williams, Chief</i>			

PURPOSE: To establish guidelines for supervisors of the Cleveland Division of Police relative to reviewing, investigating, and accounting of every Level 1 and Level 2 use of force.

POLICY: *It is the policy of the Cleveland Division of Police* that supervisors investigating use of force incidents conduct fair, thorough, timely and objective reviews of Level 1 and Level 2 uses of force. Supervisors shall evaluate attempts to de-escalate, objective reasonableness, and necessity of actions taken by the officers, along with proportionality of force used in relation to the level of resistance encountered. All Level 3 uses of force shall be investigated by the Force Investigation Team (FIT).

PROCEDURES:

I. General Guidelines

- A. Officers who use any level of force while on-duty, off-duty acting in an official capacity within the City of Cleveland, or while working secondary employment, shall contact the Communication Control Section (CCS) and request a supervisor in accordance with General Police Order 2.01.03 Use of Force - General.
- B. An immediate supervisor of the officer who used force while on-duty shall respond, as required, to the scene of the use of force incident (Refer to GPO 2.01.03).
- C. A supervisor from the district of occurrence shall respond, as required, to officer uses of force occurring while off-duty acting in an official capacity within the City of Cleveland or while working secondary employment (Refer to GPO 2.01.03).
- D. If a supervisor cannot determine the level a use of force should be categorized as, the supervisor shall immediately contact the next supervisor in their chain of command or contact the FIT via CCS for guidance.
- E. A supervisor who was involved in any Level 1 or Level 2 use of force by witnessing, participating in, or ordering the use of force shall not review or investigate the incident and shall not review the use of force entries for approval or disapproval.
- F. If a supervisor uses Level 2 force, a supervisor of a higher rank shall respond to the location of occurrence and comply with the requirements of this section. If necessary, supervisors from neighboring districts may be contacted for this purpose.
- G. In cases where officers assigned to multi-agency units or task forces are involved in a use of force incident, the Division supervisor of the task force, who is next in the chain of command that did not observe, participate in, authorize, or was not otherwise involved, shall assume investigative responsibilities of the use of force.

PAGE: 2 of 7	SUBJECT: USE OF FORCE - SUPERVISORY REVIEWS AND INVESTIGATIONS	NUMBER: 2.01.06
-----------------	---	--------------------

H. Supervisors failing to adequately review/investigate and document use of force incidents, and/or having material omissions or misrepresentations in their review/investigation when completing use of force reviews/investigations, shall be subject to the disciplinary process.

II. Responding Supervisor Responsibilities

A. Supervisors responding to any officer use of force shall:

1. Inspect and observe subjects for complaints of pain or injury resulting from the use of force response and immediately obtain necessary medical care, if not already requested.
2. Determine if the force response used is a Level 1, Level 2, or Level 3 response and make the proper notifications as needed via CCS (e.g., FIT).
3. If a supervisor determines that an officer's use of force reveals evidence of potential criminal conduct, the supervisor shall immediately:
 - a. Request the FIT via CCS and suspend any investigation.
 - b. Secure the scene pending the arrival of the FIT (Refer to GPO 2.01.07 Force Investigation Team).
4. Conduct a complete, thorough, and impartial review/investigation of the use of force incident considering whether the force used was objectively reasonable, proportional to the level of resistance, necessary, and whether the involved officer(s) took all reasonable measures to de-escalate the incident and reduce the likelihood or level of force.

III. Level 1 Use of Force Review

A. For all Level 1 use of force responses, the reviewing supervisor shall:

1. Ensure the completion of a use of force entry by each officer using force and the completion of an incident report, if necessary (Refer to GPO 2.01.05 Use of Force - Reporting).
2. Ensure that all officers witnessing a use of force incident by another officer complete a narrative statement and any other assigned reports (Refer to GPO 2.01.05 Use of Force - Reporting).
3. Address any concerns with the use of force entry, returning the entry to the officer for needed revisions. If a use of force entry is returned to the officer for revision, all revisions and additional reviews shall be completed within five days of the use of force.
4. Supervisors may review wearable camera system (WCS) recordings as necessary to assist in addressing concerns with the use of force entry.

PAGE: 3 of 7	SUBJECT: USE OF FORCE - SUPERVISORY REVIEWS AND INVESTIGATIONS	NUMBER: 2.01.06
-----------------	---	--------------------

5. If not returned to the officer for revision, review and approve the use of force report with a brief summary of the incident, conclusions, and recommendations in the entry, by the end of their tour of duty.

6. Initiate corrective action within the Division tracking software as necessary.

B. Supervisors shall elevate and investigate any Level 1 use of force that appears to have been improperly categorized as a Level 1 (Refer to GPO 2.01.01 Use of Force - Definitions and GPO 2.01.05 Use of Force - Reporting). If the supervisor cannot determine whether a use of force should be elevated, the supervisor shall consult with their superior.

IV. Level 2 Use of Force Investigations

A. For all Level 2 use of force responses and Level 1 use of force responses alleging excessive force, the responding supervisor shall, as soon as practical and no later than by the end of their tour of duty:

1. Ensure the subject is receiving necessary medical attention.

2. Interview the subject for complaints of injury resulting from the use of force. Advise the subject that the interview pertains only to the use of force and not to any underlying alleged crime and that the subject need not answer questions.

3. Conduct a complete, thorough, and impartial investigation of the use of force incident.

4. Conduct interviews with involved officers and any officers on scene when the force was used.

a. Ensure that involved officers are interviewed separately and apart from one another. Group interviews are prohibited.

b. Supervisors shall not ask officers or other witnesses leading questions that suggest legal justification for the officers' conduct where such questions are contrary to appropriate law enforcement techniques.

5. Ensure that a canvass for civilian witnesses is conducted and interview all civilian witnesses.

a. Supervisors shall either record the interview or encourage civilian witnesses to provide and sign a written statement in their own words.

b. If witnesses do not want to be interviewed, the supervisor shall attempt to document their contact information if practical and reasonable, if not recorded on the WCS.

PAGE: 4 of 7	SUBJECT: USE OF FORCE - SUPERVISORY REVIEWS AND INVESTIGATIONS	NUMBER: 2.01.06
-----------------	---	--------------------

6. Photograph, if feasible, the subject and/or officers allegations of injury or the absence of injury. Include photos of the area of the alleged injury, an overall photo of the subject and/or officer, or document the reasons photographs were not taken.
 7. Ensure that any evidence that could establish material facts related to the use of force, including audio and video recordings, photographs, and other documentation of injuries or the absence of injuries, is collected to include but not be limited to:
 - a. Proper download of an officer's CEW if deployed.
 - b. Proper download of the WCS for officers present at the use of force.
 - c. A canvass for additional/private owned video, documenting the efforts.
 - d. WCS recording of the scene and any damage to property as necessary.
 - e. Subject and/or officer medical paperwork if applicable.
 8. Ensure the completion of a use of force entry by each officer using force and completion of an incident report before the end of their tour of duty (Refer to GPO 2.01.05 Use of Force - Reporting).
 9. Ensure that all officers witnessing a use of force incident by another officer complete a narrative statement and other assigned reports before the end of their tour of duty (Refer to GPO 2.01.05 Use of Force - Reporting).
 10. Provide a brief synopsis to their Commander via email, copying their immediate supervisor, documenting the supervisor's preliminary determination of the appropriateness of the use of force.
- B. Within five tours of duty of the use of force, the investigating supervisor shall complete and document their investigation within the use of force entry. Any extension to this deadline must be authorized by a commander via email. The investigating supervisor shall:
1. Ensure that all use of force reports include all the required information and review computer aided dispatch information to identify all officers who were involved in the incident, witnessed the incident, or were on the scene when it occurred.
 2. Make all reasonable efforts through the review process to resolve material inconsistencies between the officer, subject, and witness statements, as well as inconsistencies between the level of force claimed by the officer and the subject's injuries, and any inconsistencies between multiple officers.
 3. Consider all relevant evidence, including circumstantial, direct and physical evidence as appropriate, making and explaining credibility determinations, if feasible.

PAGE: 5 of 7	SUBJECT: USE OF FORCE - SUPERVISORY REVIEWS AND INVESTIGATIONS	NUMBER: 2.01.06
-----------------	---	--------------------

4. Review all evidence relevant to the use of force, to include WCS recordings, and evaluate that evidence to determine whether the use of force was consistent with Division policy, and/or raises any policy, training, tactical, or equipment concerns.
 5. Complete the narrative description of the use of force incident, including (if not included in the dropdown menus in the Division tracking software):
 - a. The supervisor's description of the incident, including a precise description of the evidence that either justifies or fails to justify the officers' conduct based on the supervisor's independent review of the facts and circumstances of the incident.
 - b. Documentation of all evidence gathered, including names, phone numbers, and addresses of witnesses to the incident in the Division tracking software menus). In situations in which there are no known witnesses, the report shall specifically state that fact. In situations in which witnesses were present but circumstances prevented the supervisor from determining the identification, phone number, or address of those witnesses, the report shall state the reason why. The report shall include all available identifying information for anyone who refused to provide a statement.
 - c. The names of all officers who used force or witnessed the use of force.
 - d. The investigating supervisor's evaluation of the use of force, based on the supervisor's review of the evidence gathered, including:
 - i. A determination of whether the officers' actions appear to be within policy and consistent with state and federal law;
 - ii. An assessment of the incident for policy, training, tactical or equipment concerns; and
 - iii. Whether the use of force may have been avoided through the use of de-escalation techniques or lesser force options.
 - e. Document any corrective action taken or misconduct discovered during the investigation of the use of force.
 6. Investigations shall not be delayed due to extended absences from duty (e.g., furloughs, illness, etc.). The Platoon Commander or Unit OIC shall ensure another supervisor is designated to complete the investigation prior to any extended absences from duty to avoid undue delay.
- C. Supervisors shall elevate any Level 2 use of force that appears to have been improperly categorized as a Level 2 (Refer to GPO 2.01.01 Use of Force - Definitions and GPO 2.01.05 Use of Force - Reporting) and make proper notification of the FIT via CCS. If the supervisor cannot determine whether a use of force should be elevated, the supervisor shall consult with their superior and the FIT.

PAGE: 6 of 7	SUBJECT: USE OF FORCE - SUPERVISORY REVIEWS AND INVESTIGATIONS	NUMBER: 2.01.06
-----------------	---	--------------------

V. Chain of Command Review of Investigation

- A. Supervisors shall forward their completed use of force review or investigation, via the use of force tracking software, through their chain of command to the District/Unit Commander.
 - 1. Each level in the chain of command shall review the report within three tours of duty of receiving it to ensure that it is complete and that the findings are supported using the preponderance of the evidence standard.
 - a. Investigations shall not be delayed due to extended absences from duty (e.g., furloughs, extended illness).
 - b. The Patrol Section Captain or Unit OIC shall ensure another supervisor is designated to complete reviews of investigations prior to any extended absences from duty to avoid undue delay in the completion of the investigations.
- B. Reviewing supervisors in the chain of command shall address any discrepancy and order additional investigation when it appears that there is additional relevant evidence that may assist in resolving inconsistencies or improve the reliability or credibility of the findings.
- C. Any reviewing supervisor may re-categorize a use of force investigation as appropriate:
 - 1. Use of force investigations re-categorized as a Level 1 or Level 2 shall be returned to the investigating supervisor.
 - 2. Use of force investigations re-categorized from Level 2 to Level 3 requires the immediate notification of the FIT.
- D. Where the findings of the use of force investigation are not supported by a preponderance of the evidence, the investigating supervisor's chain of command shall document the reasons for this determination and shall include this documentation as an addendum to the original investigation.
 - 1. The reviewing supervisor shall counsel the investigating supervisor regarding the inadequately supported determination and of any investigative deficiencies that led to it, returning the investigation to the investigating supervisor for revision.
 - 2. Significant or repeated failures in the adequacy of Use of Force investigations may result in additional training or the imposition of discipline up to and including demotion or termination.
- E. Any investigation returned to the investigating supervisor shall address the reason(s) for return. The investigation shall be returned through the chain of command within three tours of duty.
- F. Commanders shall be responsible for the accuracy and completeness of use of force investigations prepared by supervisors under their command.

PAGE: 7 of 7	SUBJECT: USE OF FORCE - SUPERVISORY REVIEWS AND INVESTIGATIONS	NUMBER: 2.01.06
------------------------	--	---------------------------

- G. When the commander finds that the Level 1 review is complete and the evidence supports the findings, the review shall be considered complete and shall be promptly forwarded via use of force tracking software, routed to and maintained by the Internal Affairs Unit.
- H. When the commander finds that the Level 2 investigation is complete and the evidence supports the findings, the investigation file shall be promptly forwarded via use of force tracking software, routed to the Internal Affairs Superintendent.
- I. Internal Affairs shall review Level 2 investigations to ensure that they are complete and that the evidence supports the findings. When Internal Affairs completes its review, it shall route Level 2 investigations via the use of force tracking software as follows:
 - 1. Level 2 investigations without a determination of misconduct shall be routed to the appropriate Deputy Chief's Office for review.
 - 2. Level 2 investigations with a determination of misconduct shall be routed to the Case Preparation Unit and copying the appropriate Deputy Chief and Commander
- J. After investigation, if a use of force is found to be out of policy, the Case Preparation Unit shall direct and ensure the appropriate disciplinary process.
- K. Upon the completion of the Deputy Chief's review or completion of the disciplinary process, Level 2 investigations shall be closed, routed to Internal Affairs and maintained in the use of force tracking software.
- L. At the discretion of the Chief, Chief's designee, or Internal Affairs, a use of force investigation may be assigned or re-assigned for investigation to the FIT or to another supervisor, whether within or outside of the district in which the incident occurred, or may be returned to the district for further investigation or analysis. This assignment or re-assignment shall be explained in writing and routed via the Division tracking software.

THIS ORDER SUPERSEDES ANY PREVIOUSLY ISSUED DIRECTIVE OR POLICY FOR THIS SUBJECT AND WILL REMAIN EFFECTIVE UNTIL RESCINDED OR SUPERSEDED.



CLEVELAND DIVISION OF POLICE

GENERAL POLICE ORDER



EFFECTIVE DATE: JULY 8, 2020	CHAPTER: 2 - Legal	PAGE: 1 of 4	NUMBER: 2.01.07
SUBJECT: FORCE INVESTIGATION TEAM			
CHIEF: <i>Calvin D. Williams, Chief</i>			

PURPOSE: To establish guidelines for the reporting of all use of force responses and any incidents investigated by the Force Investigation Team (FIT) and to establish the duties, responsibilities, and authority of the FIT. The FIT is designed to ensure that all incidents assigned to the FIT are investigated fully and fairly.

POLICY: It is the policy of the Division to have the FIT investigate all Level 3 use of force incidents, critical firearm discharges, uses of force involving potential criminal conduct by an officer, all incidents in which an individual has died while in, or as an apparent result of being in the Division’s custody, and any uses of force assigned to the FIT by the Chief. Individuals assigned to the FIT will receive, at least yearly, training to ensure the appropriate expertise, independence, and investigative skills. This training will ensure that uses of force that are contrary to law or policy are identified; that training, tactical, and equipment deficiencies related to the use of force are identified; and that investigations are of sufficient quality. When the team is deployed, it shall be recognized as having been granted full investigative authority by the Chief of Police.

PROCEDURES:

I. FIT Investigations

- A. The FIT shall conduct administrative and criminal investigations, where appropriate and not assigned to another agency, in all of the following instances:
 1. All law enforcement critical firearm discharges occurring within the jurisdiction assigned to the Cleveland Division of Police, regardless of the on-duty or off-duty status of the officer involved, except:
 - a. Incidents involving a fatality are investigated by an outside agency per a signed memorandum of understanding.
 2. All Level 3 use of force incidents (Refer to General Police Order 2.01.01 Use of Force - Definitions).
 3. Any use of force involving potential criminal conduct by an officer.
 4. Incidents that result in death while in or as an apparent result of being in custody.
 5. Use of force investigations as reassigned by the Chief of Police or Chief’s designee.

II. FIT Notifications

PAGE: 2 of 4	SUBJECT: FORCE INVESTIGATION TEAM	NUMBER: 2.01.07
-----------------	--------------------------------------	--------------------

- A. Supervisors notified of a Level 3 use of force, critical firearm discharges, including by outside agencies, are required to immediately notify the Communications Control Section (CCS) of the nature, location and time of the incident and request they notify the Commander of the Bureau of Special Investigations (BSI).
- B. CCS shall immediately notify the Commander of BSI or the on-call designee and provide all available information.
- C. The Commander of BSI will provide instructions to a CCS supervisor to initiate a FIT call-up as required. The Internal Affairs Superintendent is ultimately responsible for determining if an incident requires a FIT investigation.

III. FIT Investigation Responsibilities

- A. The first non-involved supervisor shall:
 - 1. Respond to scene and ensure it is secured, separate the involved and witnessing officers, and direct them not to speak to each other about the incident (Refer to GPO 5.10.01 Crime Scene Preservation and Processing and GPO 5.10.02 Crime Scene Entry Log).
 - 2. Obtain a public safety statement (refer to attachment), which involved officers shall provide, that shall include any information that is necessary for providing public safety, obtaining medical care for injured persons, and securing and identification of evidence in furtherance of criminal investigations involving the subject against whom force was used.
 - 3. Not permit involved officers to review video or audio of the incident including any wearable camera system (WCS), any data in the possession of the CCS, or any mobile data terminal (MDT) prior to their initial FIT interview without the approval of the FIT OIC.
 - 4. Assist the FIT OIC as directed.
- B. Under the direction of the FIT OIC, the FIT shall perform its assigned functions, including:
 - 1. Upon arrival assume control of the scene, the use of force investigation, and the Crime Scene Entry Log noting in the log any personnel not already listed.
 - 2. Arrange for a response by selected Crime Scene and Record Unit detectives to photograph and process the scene
 - 3. Examine the subject for injury and interview the subject for complaints of pain. Ensure that the subject receives medical attention from an appropriate medical provider. Advise the subject that the interview pertains only to the use of force, not any underlying alleged crime, and that the subject need not answer questions.
 - 4. Collect all evidence consistent with homicide investigation protocols related to the use of force incident to include conducting round counts, accounting for all shots

PAGE: 3 of 4	SUBJECT: FORCE INVESTIGATION TEAM	NUMBER: 2.01.07
-----------------	--------------------------------------	--------------------

fired, audio and video recordings, photographs, and other documentation of injuries or the absence of injuries.

5. Ensure that a canvass for all civilian witnesses is conducted and interview all civilian witnesses.
6. Ensure that all civilian witness interviews are recorded, with preference towards video recording of interviews of significant witnesses or encourage civilian witnesses to provide and sign written statements, in their own words, where circumstances do not support conducting a recorded interview.
7. Ensure information is taken from civilian witnesses who have pertinent information, even if they refuse to be recorded or refuse to complete or sign a formal statement.
8. Request voluntary statements from involved officers as soon as and to the extent possible. Unless there are exceptional circumstances, the FIT investigators (administrative) will conduct the preliminary interview with involved officers before the end of the involved officer's tour of duty and complete the initial use of force tracking software entry.
9. The FIT shall secure all involved weapons and download involved officer's CEW data if deployed. In addition, the FIT investigators will direct the involved officers to transfer custody of their body armor, uniform, extra ammunition, leather gear, equipment, or other items as needed.
 - a. If a firearm is seized from an involved officer, a replacement firearm will be provided to the officer.
10. Ensure all officers who witness or are otherwise involved in the incident are interviewed before the end of their tour of duty consistent with applicable law.
 - a. To the extent possible, officers will be separated until interviewed.
 - b. Witnessing officers will be ordered not to discuss the incident with any other officers.
 - c. Group interviews are prohibited.
11. Ensure officers or other witnesses are not asked leading questions that suggest legal justifications for the officers conduct when such questions are contrary to appropriate law enforcement techniques.
12. Record all interviews with a preference towards video recording whenever possible.
13. Arrange for WCS video downloads, locking, and return.

PAGE: 4 of 4	SUBJECT: FORCE INVESTIGATION TEAM	NUMBER: 2.01.07
-----------------	--------------------------------------	--------------------

14. Inspect any weapon or equipment of any officer who is or was at any use of deadly force scene regardless of rank or position.
15. Review all WCS recordings related to any incident involving a Level 3 use of force or any incident falling within the jurisdiction of the FIT.

IV. Reporting

A. The FIT OIC shall ensure:

1. All FIT investigation reports identify all officers who were involved in the incident, witnessed the incident, or were on the scene when it occurred.
2. All officers witnessing or present during the use of force or critical firearm discharge by another officer complete a Witness Statement Form, as directed, before the end of their tour of duty, providing a detailed account of the incident from the officer's perspective (Refer to GPO 2.01.05 Use of Force - Reporting).
3. All reasonable efforts are taken through the investigation to resolve material inconsistencies between the officer, subject, and witness statements, as well as inconsistencies between the level of force claimed by the officer and the subject's injuries.

THIS ORDER SUPERSEDES ANY PREVIOUSLY ISSUED DIRECTIVE OR POLICY FOR THIS SUBJECT AND WILL REMAIN EFFECTIVE UNTIL RESCINDED OR SUPERSEDED.



CLEVELAND DIVISION OF POLICE

Public Safety Statement

Reference Number _____

The Cleveland Division of Police is conducting an investigation into the above mentioned Level 3 Use of Force. Officers shall provide the following information to the first non-involved supervisor responding to a use of force requiring a FIT response:

1. A description of the scene that needs to be protected.
 - Location of unsecured weapons
2. Identification and location of involved parties/witnesses.
3. Description of suspects still at large
 - Direction of travel, how long ago
 - Are the suspects armed
4. Direction of shots fired, if applicable.
5. Whether officer or anyone else is injured and their location.
6. The type of force used by the officer and threat presented by other involved parties.
7. Any information that would help ensure officer and public safety and assist in the apprehension of suspects

Supervisor _____ Date _____



CLEVELAND DIVISION OF POLICE

GENERAL POLICE ORDER



EFFECTIVE DATE: February 18, 2020	CHAPTER: 2 - Legal	PAGE: 1 of 6	NUMBER: 2.01.08
SUBJECT: FORCE REVIEW BOARD			
CHIEF: <i>Calvin D. Williams, Chief</i>			

PURPOSE: To ensure that investigations of use of force incidents are thorough, comprehensive and of the highest quality. The Division shall continually analyze tactics, training, policies, processes, and procedures in order to continually improve, regardless of whether the application of force in any given incident was consistent or inconsistent with policy.

POLICY: The Cleveland Division of Police has established a Force Review Board (FRB) to serve as a quality control mechanism for uses of force and force investigations and to appraise use of force incidents from tactics, training, policy, and agency improvement perspectives.

The FRB shall review selected use of force investigations to determine whether the investigation was thorough and complete; determine whether there are considerations that need to be addressed regarding de-escalation, supervision, equipment, tactics, training, policy, and best practices; determine whether the chain of command has appropriately identified and taken actions to correct deficiencies; identify trends or patterns of deficiencies; and monitor all aspects of the Division’s use of force practices with the goal of continual improvement. FRB members or their designees are expected to attend all FRB meetings and be fully prepared in advance.

PROCEDURES:

- I. Composition of the Force Review Board
 - A. The FRB shall be comprised of a representative from the following units/districts, selected by the unit/district Commander/Administrator as standing members of the FRB. The FRB shall consist of, at a minimum:
 1. The Chief of Police or designee, who shall serve as Chair of the FRB.
 2. The Bureau of Compliance (BOC).
 3. Internal Affairs (IA).
 4. A Training Section supervisor.
 5. The Office of Professional Standards (OPS) Administrator.
 6. A supervisor from each district, serving a minimum term of 12 months, when any involved officers are assigned to their district.
 7. The Data Analysis and Collection Coordinator (DACC). The DACC shall serve as a non-voting advisory member of the FRB.

PAGE: 2 of 6	SUBJECT: FORCE REVIEW BOARD	NUMBER: 2.01.08
-----------------	--------------------------------	--------------------

- B. The FRB may include or consult with any subject matter expert or advisor the Chair believes would be helpful in reviewing particular incidents. Any subject matter expert or advisor shall be non-voting members.

II. Frequency of Force Review Board Meetings

- A. The FRB shall convene quarterly.
- B. As necessitated by submitted investigations, the Chair may schedule special meetings more frequently.

III. Cases Reviewed by the Force Review Board

- A. The DACC shall provide the BOC Commander with a list of investigations from the use of force tracking software completed since the prior FRB meeting. The following investigations shall be provided for review by the FRB members two weeks prior to a scheduled meeting:

- 1. All Force Investigation Team (FIT) investigations.
- 2. All Level 2 investigations with a finding of force related misconduct.
- 3. A random sample of all Level 2 force in which there was no finding of force related misconduct. The sample will consist of ten percent of all such Level 2 investigations or five such Level 2 investigations per meeting, whichever is greater. The DACC will specify the method for selecting the random sample of completed investigations of force incidents and will memorialize that method for the FBR.

- B. The BOC Commander will provide members a complete copy of investigations to be reviewed two weeks prior to the FBR meeting.

- C. The FRB shall conduct comprehensive and reliable reviews of investigations within 90 days of receipt. An investigation is considered received by the FRB when it has been forwarded to the BOC Commander.

IV. Responsibilities of Force Review Board Members

A. FRB Member Responsibilities

- 1. Each standing member shall serve a minimum term of 12 months, unless specifically relieved due to lack of attendance, assignment change, or other material cause.
- 2. Any FRB member who is unable to attend a scheduled meeting shall notify the BOC Commander a minimum five days in advance that their assigned designee will be attending.
- 3. FRB members shall complete, at a minimum, a four hour initial training course as soon as practicable, upon being appointed, to include, but not limited to, training on the CDP use of force policies and the policies and procedures used by the FRB.

PAGE: 3 of 6	SUBJECT: FORCE REVIEW BOARD	NUMBER: 2.01.08
-----------------	--------------------------------	--------------------

4. Members shall receive annual training directly relevant to their role and service on the FRB which may include but is not limited to:
 - a. Legal updates regarding use of force.
 - b. Updates to CDP policies.
 - c. Use of force investigations best practices.
 - d. Curriculum utilized by the Training Section regarding the use of force.

B. BOC Commander Responsibilities

1. The BOC Commander is responsible for ensuring administrative and logistical assistance to the FRB in order to ensure dissemination of materials and smooth operation of FRB meetings.
2. The BOC Commander is responsible for communication of FRB findings to the Chief of Police and follow up of FRB recommendations across the Division.

V. Procedure for Review and Adjudication of Cases by the Force Review Board

- A. The Chief of Police or designee shall chair the FRB and shall preside over the meeting.
- B. The Chair shall guide the board through completion of the FRB checklist. The Chair shall recognize members to ask questions.
 1. The FRB must vote on the answers to all questions and administratively approve or disapprove for each section.
 2. Each question shall be addressed and voted upon in the order listed.
- C. For each incident under review, the FRB shall hear a case presentation from:
 1. The lead FIT investigator for FIT investigations; or
 2. A representative from the district of occurrence for supervisory investigations involving Level 2 uses of force.
- D. For each review, the FRB shall consider the actions and lack of actions of all officers, supervisors, commanders, and dispatchers involved in the incident. The FRB's review includes, but is not limited to:
 1. An officer's decision-making at the time the officer used force, including whether the incident raises policy concerns.
 2. The circumstances leading up to the use or application of force, including whether the incident raises policy concerns.
 3. Tactical decisions.

PAGE: 4 of 6	SUBJECT: FORCE REVIEW BOARD	NUMBER: 2.01.08
-----------------	--------------------------------	--------------------

4. Information sharing and communication.
 5. Adequacy of supervision throughout the incident.
 6. Equipment.
 7. Training.
 8. CDP medical response, when applicable.
 9. Any commendable actions.
- E. The FRB shall also review any material, written or recorded evidence from the incident and discuss the case as necessary with the investigator or district representative to gain a full understanding of the facts of the incident.
- F. Each FRB review shall include an assessment of the integrity, comprehensiveness, objectivity, thoroughness, and timeliness of all aspects of the use of force investigation. The FRB must ensure that the force investigation is objective and complete, and that investigatory findings are supported by a preponderance of the evidence. Where the findings are not supported by a preponderance of the evidence, the FRB will do either of the following:
1. Order additional investigation when it appears that there is additional relevant evidence that may assist in resolving inconsistencies or improve the reliability or credibility of force investigations.
 - a. The Chair or designee shall be responsible for returning the investigation to the primary unit supervisor/investigator.
 - b. The returned investigation shall include requests for specific information, concerns about inconsistencies, or concerns in the investigation.
 - c. Upon return ensure review by the FRB as expeditiously as possible.
 2. Document the reasons for the determination that the findings are not supported by a preponderance of the evidence. Include the specific evidence or analysis supporting the conclusions and forward the recommendations to the Chief of Police.
- G. The FRB shall make separate, formal findings of administrative approval or administrative disapproval for each involved employee in each incident with respect to the following:
1. Tactics and decision making.
 2. Use of force.
 3. Supervision.
 4. The underlying use of force investigation.

PAGE: 5 of 6	SUBJECT: FORCE REVIEW BOARD	NUMBER: 2.01.08
-----------------	--------------------------------	--------------------

- H. All findings of the FRB must be supported by a preponderance of the evidence.
- I. The FRB shall not make determinations or recommendations about discipline; however, where appropriate, the FRB may recommend non-disciplinary corrective action to enable or encourage an officer to improve performance.
- J. Only standing and voting members of the FRB may participate in the deliberations during meetings.
- K. All FRB determinations shall be made by majority vote.
 - 1. Only standing and voting members of the FRB are permitted to vote and shall not abstain from voting on any matter unless authorized in advance by the Chair. The FRB member shall immediately notify the Chair upon learning that abstention is necessary to avoid a conflict of interest.
 - 2. The FRB Chair shall vote in cases of a tie (the vote is evenly split).
- L. The Chair or designee shall ensure accurate recording of all findings of the FRB including the determinations on the FRB checklist.
- M. The Chair shall refer policy, equipment, and training issues to the appropriate commander at the conclusion of each incident review. The Chair shall assign follow up regarding the recommendations from the FRB.
- N. If the use of force indicates policy, training, tactical or equipment concerns, the Chief or designee shall ensure that FRB's recommendations are implemented as appropriate, any necessary training is conducted, and that policy, training, tactical, or equipment concerns are resolved. This implementation includes any non-disciplinary corrective action.
- O. The FRB shall use a tracking system to ensure that each of its recommendations (regarding individual employees, training, policy, equipment, communication, or other issues) has been forwarded to the appropriate Division personnel.
- P. BOC Commander Responsibilities
 - 1. The BOC Commander shall ensure that the FRB's findings for each involved employee are documented in a report to the Chief of Police within 15 days of the presentation of the case to the FRB.
 - 2. The BOC Commander shall maintain a record of all recommendations and their implementation status.

VI. Reporting

- A. The BOC Commander shall provide a quarterly report to the FRB. The report shall contain the status of the FRB recommendations and the response from the commanders.

PAGE: 6 of 6	SUBJECT: FORCE REVIEW BOARD	NUMBER: 2.01.08
-----------------	--------------------------------	--------------------

- B. The FRB shall examine data related to use of force at least once per year. The annual examination is to detect any patterns, trends, and training deficiencies and is to make recommendations for correction, as appropriate. The analysis will be conducted in conjunction with the DACC.

THIS ORDER SUPERSEDES ANY PREVIOUSLY ISSUED DIRECTIVE OR POLICY FOR THIS SUBJECT AND WILL REMAIN EFFECTIVE UNTIL RESCINDED OR SUPERSEDED.



Cuyahoga County Regional Forensic Science Laboratory

Evidence Submission Sheet

This form must be completed for all cases except for those requiring only Drug Testing and/or Test Firing of Firearms.

CCRFSL Case Number:
Agency Case Number:

Note: No DNA, Drug or Fingerprint testing will be performed on 'Property Found'.

NEW CASE	ADD'L EVI.	Submitting Agency:	Submitting Officer
Investigating Officer/Contact Person:		Phone Number:	Email:
Offense:		Date of Offense/Discovery	Synopsis Attached? Yes No
Grand Jury Date		Trial Date, if known	
Name:	Victim Suspect	D.O.B.	Name: Victim Suspect D.O.B.

Requested Testing: (Note: CCRFSL may refuse any testing considered unsuitable/unacceptable as per CCRFSL Evidence Submission Policies)

List Item Numbers ↓ (Check Appropriate Testing→)	DNA	Finger prints	Drug Chemistry	Trace	GSR	Firearms	NIBIN	Test Fire

Please specify your comparison requests (What items need to be compared):

Information Required for Firearms Testing:

1. Is there any reason why the submitted ammunition cannot be used for test firing?	Yes	No	2. Are the submitted cartridge case(s) evidence or test fire(s)?	
			Evidence : _____	Test Fire(s) : _____
If test fire(s), provide the firearm information:	Make	Model	Serial Number	Caliber

Information Required for DNA, Fingerprints and/or Trace Analysis:

1. If hair, fibers, paint analysis is requested, have known samples been provided?	Yes	No
2. Was the evidence item(s) collected from the suspect's person or in suspect's possession when collected by law enforcement?	Yes	No
3. Could the DNA or Fingerprints on the evidence be from an individual who is not a suspect? (e.g. police officer collecting the evidence/ witness/ victim's partner who is not a suspect)	Yes	No
If yes, have elimination Fingerprints and DNA standards been submitted?	Yes	No

Please complete page 2 for all Non-Sexual Assault DNA Testing requests.

(Not required for non-DNA requests)



Cuyahoga County Regional Forensic Science Laboratory Evidence Submission Sheet

CCRFSL Case Number:
Agency Case Number:

Information Required for Non-Sexual Assault DNA Testing: (For sexual assaults, please complete the 'DNA Sexual Assault Ev. Sub. Checklist'.)

1. Has the permission to consume the touch DNA evidence been submitted? Yes No If no, provide Information below*
(Testing will not start until the permission to consume is received for all touch DNA evidence.)

*Consumption Permission to be granted by: _____

2. Any weapon used? Yes No If yes, explain: _____

3. Was anyone bleeding? Victim Subject Other (explain): _____

4. Victim's relationship to subject: _____

5. Have the victim and subject had prior physical contact? Yes No Unknown

If yes, explain: _____

6. Did the victim/subject have prior contact with the crime scene? Victim: Yes No Unknown

Subject: Yes No Unknown

7. Location where the victim was found: _____

8. Approximate time length between the assault/crime and discovery of the victim/evidence: _____

9. If suspect's clothing is submitted, was it worn during the alleged offense? Yes No

10. Were the evidence items collected at or near the crime scene? Yes- Item(s)#: _____

If no, provide location and relationship of these items to the crime: No- Item(s)#: _____

11. Suspect's standard submitted? Yes No

12. Please attach or write a short summary of the crime **clearly mentioning** the connection of the evidence items to the crime:

Information provided by:

Agency Representative

Date



THE CUYAHOGA COUNTY SHERIFF'S DEPARTMENT

THE JUSTICE CENTER 1215 West 3rd Street, Cleveland, Ohio 44113

Criminal Investigation Notification

1. This investigation is being conducted in order to determine whether any criminal laws have been violated on the part of those involved in this incident. Specifically, to collect facts and information to be provided to the prosecutor and/or grand jury in order for them to determine whether the conduct involved is authorized or prohibited by criminal statutes.
2. Your participation in this interview is voluntary and you may decline to answer or cease the interview at any time. You are entitled to have an attorney present if you wish.
3. The criminal investigation is separate from any internal, administrative investigation which your employer may or may not be independently conducting. You are not being compelled to give any statement or answer any questions. This is not a "Garrity" interview (where you could be required to answer).

JUAN A. Cedeno
Printed Name of Interviewee

5-14-2021
Date / Time

~~JKC~~
Signature of Interviewee

Jeff Ball
654

ROGER GIBSON #40
CCSD Detective (Printed)
[Signature] #40
CCSD Detective (Signature)



THE CUYAHOGA COUNTY SHERIFF'S DEPARTMENT

THE JUSTICE CENTER 1215 West 3rd Street, Cleveland, Ohio 44113

Criminal Investigation Notification

1. This investigation is being conducted in order to determine whether any criminal laws have been violated on the part of those involved in this incident. Specifically, to collect facts and information to be provided to the prosecutor and/or grand jury in order for them to determine whether the conduct involved is authorized or prohibited by criminal statutes.
2. Your participation in this interview is voluntary and you may decline to answer or cease the interview at any time. You are entitled to have an attorney present if you wish.
3. The criminal investigation is separate from any internal, administrative investigation which your employer may or may not be independently conducting. You are not being compelled to give any statement or answer any questions. This is not a "Garrity" interview (where you could be required to answer).

Gino Terak
Printed Name of Interviewee

5-14-21 11:40
Date / Time

[Signature]
Signature of Interviewee

[Signature]
654

ROGER G. BOCA
CCSD Detective (Printed)

[Signature] #44
CCSD Detective (Signature)



THE CUYAHOGA COUNTY SHERIFF'S DEPARTMENT

THE JUSTICE CENTER 1215 West 3rd Street, Cleveland, Ohio 44113

Criminal Investigation Notification

1. This investigation is being conducted in order to determine whether any criminal laws have been violated on the part of those involved in this incident. Specifically, to collect facts and information to be provided to the prosecutor and/or grand jury in order for them to determine whether the conduct involved is authorized or prohibited by criminal statutes.
2. Your participation in this interview is voluntary and you may decline to answer or cease the interview at any time. You are entitled to have an attorney present if you wish.
3. The criminal investigation is separate from any internal, administrative investigation which your employer may or may not be independently conducting. You are not being compelled to give any statement or answer any questions. This is not a "Garrity" interview (where you could be required to answer).

Fred Brown Jr.
Printed Name of Interviewee

5/14/2021
Date / Time

Fred Brown Jr.
Signature of Interviewee

Jeff Hall 054

Det. J. Goudy '12
CCSD Detective (Printed)

[Signature]
CCSD Detective (Signature)



THE CUYAHOGA COUNTY SHERIFF'S DEPARTMENT

THE JUSTICE CENTER 1215 West 3rd Street, Cleveland, Ohio 44113

Criminal Investigation Notification

1. This investigation is being conducted in order to determine whether any criminal laws have been violated on the part of those involved in this incident. Specifically, to collect facts and information to be provided to the prosecutor and/or grand jury in order for them to determine whether the conduct involved is authorized or prohibited by criminal statutes.
2. Your participation in this interview is voluntary and you may decline to answer or cease the interview at any time. You are entitled to have an attorney present if you wish.
3. The criminal investigation is separate from any internal, administrative investigation which your employer may or may not be independently conducting. You are not being compelled to give any statement or answer any questions. This is not a "Garrity" interview (where you could be required to answer).

Anthony Compton
Printed Name of Interviewee

5-14-2021 / 10:26 am
Date / Time

[Signature]
Signature of Interviewee

Jeff Bell 056
CPA

Det. J. Goudy '12
CCSD Detective (Printed)

[Signature]
CCSD Detective (Signature)



THE CUYAHOGA COUNTY SHERIFF'S DEPARTMENT

THE JUSTICE CENTER 1215 West 3rd Street, Cleveland, Ohio 44113

Criminal Investigation Notification

1. This investigation is being conducted in order to determine whether any criminal laws have been violated on the part of those involved in this incident. Specifically, to collect facts and information to be provided to the prosecutor and/or grand jury in order for them to determine whether the conduct involved is authorized or prohibited by criminal statutes.
2. Your participation in this interview is voluntary and you may decline to answer or cease the interview at any time. You are entitled to have an attorney present if you wish.
3. The criminal investigation is separate from any internal, administrative investigation which your employer may or may not be independently conducting. You are not being compelled to give any statement or answer any questions. This is not a "Garrity" interview (where you could be required to answer).

Daniel W. Piper Jr
Printed Name of Interviewee

5-14-2021/1212
Date / Time

Daniel W. Piper Jr #1113
Signature of Interviewee

Jeff Bell 054

[Signature]
CCSD Detective (Printed)

Det. J. Goudy
CCSD Detective (Signature)

10:03: GEROME OUT 1009
 GIBSON OUT 1013
 FULMER # 654 1012
 GOVDY 1013
 BARTCZAK OUT 1007
 SMITH OUT ~~1009~~ 1009
 GOMEZ #MURDER 9135 OUT 1005
 GRAVES 2225 OUT 1008
 MUSSELL # 9240 OUT 1008
 KLOOS 1013
 LAMPKIN # 2462 OUT 1008
 RAY DIAZ OUT 1007
 VEVERKA IN 1006 OUT 1007

8114 CRIME SCENE

ROBINSON 156A IN 1011 ~~OUT~~ 1012
 8114 " CROWELL 281 IN 1011 OUT 1012
 GIBSON IN 1017 OUT 1020
 KLOOS IN 1017 OUT 1020
 LT PETRANIC IN 1017
 CHRIS MILLER # 471 1017 1018
 GENTILE TOOK OVER

Cuyahoga County Sheriff's Office

Department Case Report

Department Case Number: 21015453

Related Case # 's: IN2021-00707

Case Information

Case Officer: 12 - Goudy II, Joseph W
Offense Date/Time: 04/15/2021 - 09:20Hrs
Offense Location: 4281 East 134th Street, Cleveland, Ohio 44112
Offense Type: SHOOT - Fatal Shooting By Officer
Expiration Date:
Jurisdiction: Cuyahoga
Court Date:
Disposition:
Disposition Date:
Case Comments:

Case Names

Name Type: Government			
Business Name: City Of Cleveland Division Of Polic			Home Phone#:
Contact Name:			Work Phone#:
Address:			ID#:
Additional Name Information:			SSN#:
Name Type: Other			
Business Name: CLEVELAND POLICE DEPARTMENT			Home Phone#:
Contact Name: PIPER JR, DANIEL			Work Phone#:
Address: 1300 ONTARIO ST CLEVELAND, OHIO 44113			ID#:
Additional Name Information: BADGE NUMBER: 1113 ASSIGNED 4TH DIST.			SSN#: [REDACTED]
Business Name: CLEVELAND POLICE DEPARTMENT			Home Phone#:
Contact Name: LAMPKIN, ANTHONY			Work Phone#:
Address: 1300 ONTARIO ST CLEVELAND, OHIO 44113			ID#:
Additional Name Information: BADGE NUMBER: 2462 ASSIGNED 4TH DIST.			SSN#: [REDACTED]
Name Type: Suspect			
Name: LEE JR, INNES, K	Sex: M	Race: A	DOB: 09/12/1995
Address: 3677 EAST 147TH STREET CLEVELAND, OHIO 44120			Home Phone#:
Additional Name Information:			ID#:
			SSN#: [REDACTED]

Case Items

Item Number: 001	
Container #:	Process: Hold for investigative purposes
Current Custody: To Lab	
Collection Date/Time: 04/15/2021 - 14:30Hrs	Collection Purpose: Evidence
Collected By: 86 - Watson, Michael A	
Collection Location: COLLECTED FROM BCI AGENT DAN BOERNER .	
Packaging/Quantity/Item Type: GUN BOX - 1 - firearm	
Detail Description: 9MM SMITH & WESSON MODEL:M&P9 WITH 1 LIVE ROUND FROM CHAMBER AND 7 FROM MAGZINE	
Owner: INNES LEE JR	
Serial #: HMP6782	
/	
Item Notes:	

Cuyahoga County Sheriff's Office

Department Case Report

Department Case Number: 21015453

Case Items

Item Number: 002

Container #: **Process:** Hold for investigative purposes
Current Custody: To Lab
Collection Date/Time: 04/15/2021 - 11:03Hrs **Collection Purpose:** Evidence
Collected By: 44 - Veverka, Steven
Collection Location: At CCSD From Piper's Duty Weapon
Packaging/Quantity/Item Type: Evidence bag containing - 1 - ammunition
Detail Description: One (1) live 9mm round from chamber of Piper's duty weapon.
Owner: City Of Cleveland Division Of Polic
Item Notes:

Item Number: 003

Container #: **Process:** Hold for investigative purposes
Current Custody: Item Submitted Into Property - Evidence Room 1 Drop Chute
Collection Date/Time: 04/15/2021 - 11:03Hrs **Collection Purpose:** Evidence
Collected By: 44 - Veverka, Steven
Collection Location: At CCSD From Piper's Duty Vest Pocket From Item Number 23
Packaging/Quantity/Item Type: Evidence bag containing - 1 - ammunition
Detail Description: One (1) live 9mm round
Owner: CLEVELAND POLICE DEPARTMENT
Item Notes:

Item Number: 004

Container #: **Process:** Hold for investigative purposes
Current Custody: Item Submitted Into Property - Evidence Room 1 Drop Chute
Collection Date/Time: 04/15/2021 - 11:03Hrs **Collection Purpose:** Evidence
Collected By: 44 - Veverka, Steven
Collection Location: At CCSD From Piper's Duty Belt
Packaging/Quantity/Item Type: Evidence bag containing - 1 - ammunition
Detail Description: Magazine with seventeen (17) live rounds
Owner: City Of Cleveland Division Of Polic
Item Notes:

Item Number: 005

Container #: **Process:** Hold for investigative purposes
Current Custody: Item Submitted Into Property - Evidence Room 1 Drop Chute
Collection Date/Time: 04/15/2021 - 11:03Hrs **Collection Purpose:** Evidence
Collected By: 44 - Veverka, Steven
Collection Location: At CCSD From Piper's Duty Belt
Packaging/Quantity/Item Type: Evidence bag containing - 1 - ammunition
Detail Description: Magazine with seventeen (17) live rounds
Owner: City Of Cleveland Division Of Polic
Item Notes:

Item Number: 006

Container #: **Process:** Hold for investigative purposes
Current Custody: Item Submitted Into Property - Evidence Room 1 Drop Chute
Collection Date/Time: 04/15/2021 - 11:03Hrs **Collection Purpose:** Evidence
Collected By: 44 - Veverka, Steven
Collection Location: At CCSD From Piper's Duty Belt
Packaging/Quantity/Item Type: Evidence bag containing - 1 - ammunition
Detail Description: Magazine with seventeen (17) live rounds
Owner: City Of Cleveland Division Of Polic
Item Notes:

Cuyahoga County Sheriff's Office

Department Case Report

Department Case Number: 21015453

Case Items

Item Number: 007

Container #: **Process:** Hold for investigative purposes
Current Custody: To Lab
Collection Date/Time: 04/15/2021 - 11:03Hrs **Collection Purpose:** Evidence
Collected By: 44 - Veverka, Steven
Collection Location: At CCSD From Piper's Department Duty Weapon
Packaging/Quantity/Item Type: Evidence bag containing - 1 - ammunition
Detail Description: Magazine with eleven (11) live rounds
Owner: City Of Cleveland Division Of Polic
Item Notes:

Item Number: 008

Container #: **Process:** Hold for investigative purposes
Current Custody: Item Submitted Into Property - Evidence Room 1 Drop Chute
Collection Date/Time: 04/15/2021 - 11:03Hrs **Collection Purpose:** Evidence
Collected By: 44 - Veverka, Steven
Collection Location: At CCSD From Piper's Duty Belt
Packaging/Quantity/Item Type: Evidence bag containing - 1 - Taser
Detail Description: One Axon taser yellow in color
Owner: City Of Cleveland Division Of Polic
Serial #: X130018NV
 /
Item Notes:

Item Number: 009

Container #: **Process:** Hold for investigative purposes
Current Custody: Item Submitted Into Property - Evidence Room 1 Drop Chute
Collection Date/Time: 04/15/2021 - 11:03Hrs **Collection Purpose:** Evidence
Collected By: 44 - Veverka, Steven
Collection Location: From Item Number 8
Packaging/Quantity/Item Type: Evidence bag containing - 1 - cartridge(s)
Detail Description: Two Axon Taser cartridges black and green in color
Owner: City Of Cleveland Division Of Polic
Serial #: C4105NNNR
 C4703X4FV/
Item Notes:

Item Number: 010

Container #: **Process:** Hold for investigative purposes
Current Custody: To Lab
Collection Date/Time: 04/15/2021 - 11:03Hrs **Collection Purpose:** Evidence
Collected By: 44 - Veverka, Steven
Collection Location: At CCSD From Officer Piper
Packaging/Quantity/Item Type: Evidence bag containing - 1 - handgun
Detail Description: One black GLOCK 19 with streamlight TLR-1 flashlight
Owner: City Of Cleveland Division Of Polic
Serial #: MPD932
 /
Weapon Type : P - PISTOL **Weapon Category :** I - SEMI-AUTO(autoloading) **Caliber :** 9mm
Model : 19 **Barrel Length :** 4 inches **Color :** BLK - BLACK
Gun Make : GLC - Glock, Inc.
Item Notes:

Cuyahoga County Sheriff's Office

Department Case Report

Department Case Number: 21015453

Case Items

Item Number: 011

Container #: **Process:** Hold for investigative purposes
Current Custody: To Lab
Collection Date/Time: 04/15/2021 - 11:03Hrs **Collection Purpose:** Evidence
Collected By: 44 - Veverka, Steven
Collection Location: At CCSD From Officer Piper's Cheek
Packaging/Quantity/Item Type: Envelope containing - 1 - oral swab2
Detail Description: Two Buccal DNA swabs
Owner: CLEVELAND POLICE DEPARTMENT
Item Notes:

Item Number: 012

Container #: **Process:** Hold for investigative purposes
Current Custody: To Lab
Collection Date/Time: 04/15/2021 - 11:03Hrs **Collection Purpose:** Evidence
Collected By: 44 - Veverka, Steven
Collection Location: At CCSD From Officer Piper's Cheek
Packaging/Quantity/Item Type: Envelope containing - 1 - oral swab2
Detail Description: Two Buccal DNA swabs
Owner: CLEVELAND POLICE DEPARTMENT
Item Notes:

Item Number: 013

Container #: **Process:** Hold for investigative purposes
Current Custody: To Lab
Collection Date/Time: 04/15/2021 - 11:03Hrs **Collection Purpose:** Evidence
Collected By: 44 - Veverka, Steven
Collection Location: At CCSD From Officer Piper's Right And Left Hand
Packaging/Quantity/Item Type: Envelope containing - 1 - GSR kit
Detail Description: One gunshot primer residue evidence collection kit
Owner: CLEVELAND POLICE DEPARTMENT
Item Notes:

Item Number: 014

Container #: **Process:** Hold for investigative purposes
Current Custody: Item Submitted Into Property - Evidence Room 1 Drop Chute
Collection Date/Time: 04/15/2021 - 11:03Hrs **Collection Purpose:** Evidence
Collected By: 44 - Veverka, Steven
Collection Location: At CCSD From Officer Piper's Duty Belt
Packaging/Quantity/Item Type: Evidence bag containing - 1 - other
Detail Description: Smith and Wesson chain handcuffs
Owner: City Of Cleveland Division Of Polic
Item Notes:

Item Number: 015

Container #: **Process:** Hold for investigative purposes
Current Custody: Item Submitted Into Property - Evidence Room 1 Drop Chute
Collection Date/Time: 04/15/2021 - 11:03Hrs **Collection Purpose:** Evidence
Collected By: 44 - Veverka, Steven
Collection Location: At CCSD From Officer Piper's Duty Belt
Packaging/Quantity/Item Type: Evidence bag containing - 1 - other
Detail Description: Smith and Wesson hinged handcuffs
Owner: City Of Cleveland Division Of Polic
Item Notes:

Cuyahoga County Sheriff's Office

Department Case Report

Department Case Number: 21015453

Case Items

Item Number: 016**Container #:****Process:** Hold for investigative purposes**Current Custody:** Item Submitted Into Property - Evidence Room 1 Drop Chute**Collection Date/Time:** 04/15/2021 - 11:03Hrs**Collection Purpose:** Evidence**Collected By:** 44 - Veverka, Steven**Collection Location:** At CCSD From Officer Piper's Duty Vest**Packaging/Quantity/Item Type:** Evidence bag containing - 1 - knife**Detail Description:** One Stiletto knife**Owner:** CLEVELAND POLICE DEPARTMENT**Item Notes:****Item Number: 017****Container #:****Process:** Hold for investigative purposes**Current Custody:** Item Submitted Into Property - Evidence Room 1 Drop Chute**Collection Date/Time:** 04/15/2021 - 11:03Hrs**Collection Purpose:** Evidence**Collected By:** 44 - Veverka, Steven**Collection Location:** At CCSD From Officer Piper's Duty Vest**Packaging/Quantity/Item Type:** Evidence bag containing - 1 - knife**Detail Description:** One Gerber knife**Owner:** CLEVELAND POLICE DEPARTMENT**Item Notes:****Item Number: 018****Container #:****Process:** Hold for investigative purposes**Current Custody:** Item Submitted Into Property - Evidence Room 1 Drop Chute**Collection Date/Time:** 04/15/2021 - 11:03Hrs**Collection Purpose:** Evidence**Collected By:** 44 - Veverka, Steven**Collection Location:** At CCSD From Officer Piper's Duty Belt**Packaging/Quantity/Item Type:** Evidence bag containing - 1 - other**Detail Description:** One ASP batton**Owner:** City Of Cleveland Division Of Polic**Item Notes:****Item Number: 019****Container #:****Process:** Hold for investigative purposes**Current Custody:** Item Submitted Into Property - Evidence Room 1 Drop Chute**Collection Date/Time:** 04/15/2021 - 11:03Hrs**Collection Purpose:** Evidence**Collected By:** 44 - Veverka, Steven**Collection Location:** At CCSD From Officer Piper's Duty Belt**Packaging/Quantity/Item Type:** Evidence bag containing - 1 - other**Detail Description:** One tourniquet**Owner:** City Of Cleveland Division Of Polic**Item Notes:****Item Number: 020****Container #:****Process:** Hold for investigative purposes**Current Custody:** Item Submitted Into Property - Evidence Room 1 Drop Chute**Collection Date/Time:** 04/15/2021 - 11:03Hrs**Collection Purpose:** Evidence**Collected By:** 44 - Veverka, Steven**Collection Location:** At CCSD From Officer Piper's Duty Belt**Packaging/Quantity/Item Type:** Evidence bag containing - 1 - other**Detail Description:** One Streamlight flashlight**Owner:** City Of Cleveland Division Of Polic**Item Notes:**

Cuyahoga County Sheriff's Office

Department Case Report

Department Case Number: 21015453

Case Items

Item Number: 021

Container #:
Current Custody: Item Submitted Into Property - Evidence Room 1 Drop Chute
Collection Date/Time: 04/15/2021 - 11:03Hrs
Collected By: 44 - Veverka, Steven
Collection Location: At CCSD From Officer Piper's Duty Vest
Packaging/Quantity/Item Type: Evidence bag containing - 1 - other
Detail Description: One metal handcuff key
Owner: CLEVELAND POLICE DEPARTMENT

Process: Hold for investigative purposes

Collection Purpose: Evidence

Item Notes:

Item Number: 022

Container #:
Current Custody: Item Submitted Into Property - Evidence Room 1 Drop Chute
Collection Date/Time: 04/15/2021 - 11:03Hrs
Collected By: 44 - Veverka, Steven
Collection Location: At CCSD From Officer Piper's Duty Belt
Packaging/Quantity/Item Type: Evidence bag containing - 1 - Portable Radio
Detail Description: One Motorola radio with mic
Owner: City Of Cleveland Division Of Polic
Serial #: 1851113
/

Process: Hold for investigative purposes

Collection Purpose: Evidence

Item Notes:

Item Number: 023

Container #:
Current Custody: Item Submitted Into Property - Evidence Room 1 Drop Chute
Collection Date/Time: 04/15/2021 - 11:03Hrs
Collected By: 44 - Veverka, Steven
Collection Location: At CCSD From Officer Piper's Duty Vest Pocket
Packaging/Quantity/Item Type: Evidence bag containing - 1 - other
Detail Description: Clear bag with one coin, one star and one St. Michael pendant
Owner: CLEVELAND POLICE DEPARTMENT

Process: Hold for investigative purposes

Collection Purpose: Evidence

Item Notes:

Item Number: 024

Container #:
Current Custody: Item Submitted Into Property - Evidence Room 1 Drop Chute
Collection Date/Time: 04/15/2021 - 11:03Hrs
Collected By: 44 - Veverka, Steven
Collection Location: At CCSD From Officer Piper
Packaging/Quantity/Item Type: Evidence bag containing - 1 - other
Detail Description: Duty belt with holster and keepers
Owner: City Of Cleveland Division Of Polic

Process: Hold for investigative purposes

Collection Purpose: Evidence

Item Notes:

Cuyahoga County Sheriff's Office

Department Case Report

Department Case Number: 21015453

Case Items

Item Number: 025

Container #: **Process:** Hold for investigative purposes
Current Custody: Item Submitted Into Property - Evidence Room 1 Drop Chute
Collection Date/Time: 04/15/2021 - 11:03Hrs **Collection Purpose:** Evidence
Collected By: 44 - Veverka, Steven
Collection Location: At CCSD From Officer Piper's Right Back Pocket
Packaging/Quantity/Item Type: Evidence bag containing - 1 - glove(s)
Detail Description: One green latex glove (inside out) used during CPR
Owner: CLEVELAND POLICE DEPARTMENT
Item Notes:

Item Number: 026

Container #: **Process:** Hold for investigative purposes
Current Custody: Item Submitted Into Property - Evidence Room 1 Drop Chute
Collection Date/Time: 04/15/2021 - 11:03Hrs **Collection Purpose:** Evidence
Collected By: 44 - Veverka, Steven
Collection Location: At CCSD From Officer Piper's Right Back Pocket
Packaging/Quantity/Item Type: Evidence bag containing - 1 - glove(s)
Detail Description: One green latex glove (inside out) used during CPR
Owner: CLEVELAND POLICE DEPARTMENT
Item Notes:

Item Number: 027

Container #: **Process:** Hold for investigative purposes
Current Custody: Item Submitted Into Property - Evidence Room 1 Drop Chute
Collection Date/Time: 04/15/2021 - 11:03Hrs **Collection Purpose:** Evidence
Collected By: 44 - Veverka, Steven
Collection Location: At CCSD From Officer Piper's Person
Packaging/Quantity/Item Type: Evidence bag containing - 1 - clothing
Detail Description: Dark neck gator
Owner: CLEVELAND POLICE DEPARTMENT
Item Notes:

Item Number: 028

Container #: **Process:** Hold for investigative purposes
Current Custody: Item Submitted Into Property - Evidence Room 1 Drop Chute
Collection Date/Time: 04/15/2021 - 11:03Hrs **Collection Purpose:** Evidence
Collected By: 44 - Veverka, Steven
Collection Location: At CCSD From Officer Piper's Person
Packaging/Quantity/Item Type: Evidence bag containing - 1 - clothing
Detail Description: Blue pants with black belt
Owner: City Of Cleveland Division Of Polic
Item Notes:

Item Number: 029

Container #: **Process:** Hold for investigative purposes
Current Custody: Item Submitted Into Property - Evidence Room 1 Drop Chute
Collection Date/Time: 04/15/2021 - 11:03Hrs **Collection Purpose:** Evidence
Collected By: 44 - Veverka, Steven
Collection Location: At CCSD From Officer Piper's Person
Packaging/Quantity/Item Type: Evidence bag containing - 1 - clothing
Detail Description: Blue CPD uniform shirt
Owner: City Of Cleveland Division Of Polic
Item Notes:

Cuyahoga County Sheriff's Office

Department Case Report

Department Case Number: 21015453

Case Items

Item Number: 030

Container #: **Process:** Hold for investigative purposes
Current Custody: Item Submitted Into Property - Evidence Room 1 Drop Chute
Collection Date/Time: 04/15/2021 - 11:03Hrs **Collection Purpose:** Evidence
Collected By: 44 - Veverka, Steven
Collection Location: At CCSD From Officer Piper's Person
Packaging/Quantity/Item Type: Evidence bag containing - 1 - clothing
Detail Description: Outer carrier vest with badge #1113
Owner: City Of Cleveland Division Of Polic

Item Notes:

Item Number: 031

Container #: **Process:** Hold for investigative purposes
Current Custody: Item Submitted Into Property - Evidence Room 1 Drop Chute
Collection Date/Time: 04/15/2021 - 11:03Hrs **Collection Purpose:** Evidence
Collected By: 44 - Veverka, Steven
Collection Location: At CCSD From Officer Piper's Person
Packaging/Quantity/Item Type: Evidence bag containing - 1 - pair of shoes
Detail Description: Black left boot
Owner: CLEVELAND POLICE DEPARTMENT

Item Notes:

Item Number: 032

Container #: **Process:** Hold for investigative purposes
Current Custody: Item Submitted Into Property - Evidence Room 1 Drop Chute
Collection Date/Time: 04/15/2021 - 11:03Hrs **Collection Purpose:** Evidence
Collected By: 44 - Veverka, Steven
Collection Location: At CCSD From Officer Piper's Person
Packaging/Quantity/Item Type: Evidence bag containing - 1 - pair of shoes
Detail Description: Black right boot
Owner: CLEVELAND POLICE DEPARTMENT

Item Notes:

Item Number: 033

Container #: **Process:** Hold for investigative purposes
Current Custody: Item Submitted Into Property - Evidence Room 1 Drop Chute
Collection Date/Time: 04/15/2021 - 11:03Hrs **Collection Purpose:** Evidence
Collected By: 44 - Veverka, Steven
Collection Location: At CCSD From Officer Lampkin Person.
Packaging/Quantity/Item Type: Evidence bag containing - 1 - clothing
Detail Description: Outer carrier vest with badge #2462
Owner: City Of Cleveland Division Of Polic

Item Notes:

Item Number: 034

Container #: **Process:** Hold for investigative purposes
Current Custody: Item Submitted Into Property - Evidence Room 1 Drop Chute
Collection Date/Time: 04/15/2021 - 11:03Hrs **Collection Purpose:** Evidence
Collected By: 44 - Veverka, Steven
Collection Location: At CCSD From Officer Lampkin Person
Packaging/Quantity/Item Type: Evidence bag containing - 1 - clothing
Detail Description: Blue pants with black belt
Owner: City Of Cleveland Division Of Polic

Item Notes:

Cuyahoga County Sheriff's Office

Department Case Report

Department Case Number: 21015453

Case Items

Item Number: 035

Container #:

Process: Hold for investigative purposes

Current Custody: Item Submitted Into Property - Evidence Room 1 Drop Chute

Collection Date/Time: 04/15/2021 - 11:03Hrs

Collection Purpose: Evidence

Collected By: 44 - Veverka, Steven

Collection Location: At CCSD From Officer Lampkin's Person

Packaging/Quantity/Item Type: Evidence bag containing - 1 - clothing

Detail Description: Blue CPD uniform shirt

Owner: City Of Cleveland Division Of Polic

Item Notes:

Item Number: 036

Container #:

Process: Hold for investigative purposes

Current Custody: Item Submitted Into Property - Evidence Room 1 Drop Chute

Collection Date/Time: 04/15/2021 - 11:03Hrs

Collection Purpose: Evidence

Collected By: 44 - Veverka, Steven

Collection Location: At CCSD From Officer Lampkin's Person

Packaging/Quantity/Item Type: Evidence bag containing - 1 - pair of shoes

Detail Description: Black left boot

Owner: CLEVELAND POLICE DEPARTMENT

Item Notes:

Item Number: 037

Container #:

Process: Hold for investigative purposes

Current Custody: Item Submitted Into Property - Evidence Room 1 Drop Chute

Collection Date/Time: 04/15/2021 - 11:03Hrs

Collection Purpose: Evidence

Collected By: 44 - Veverka, Steven

Collection Location: At CCSD From Officer Lampkin's Person

Packaging/Quantity/Item Type: Evidence bag containing - 1 - pair of shoes

Detail Description: Black right boot

Owner: CLEVELAND POLICE DEPARTMENT

Item Notes:

Item Number: 038

Container #:

Process: Hold for investigative purposes

Current Custody: Item Submitted Into Property - Evidence Room 1 Drop Chute

Collection Date/Time: 04/15/2021 - 11:03Hrs

Collection Purpose: Evidence

Collected By: 44 - Veverka, Steven

Collection Location: At CCSD From Officer Lampkin

Packaging/Quantity/Item Type: Evidence bag containing - 1 - other

Detail Description: Duty belt with holster and keepers

Owner: City Of Cleveland Division Of Polic

Item Notes:

Cuyahoga County Sheriff's Office

Department Case Report

Department Case Number: 21015453

Case Items

Item Number: 039

Container #:
Current Custody: Item Submitted Into Property - Evidence Room 1 Drop Chute
Collection Date/Time: 04/15/2021 - 11:03Hrs
Collected By: 44 - Veverka, Steven
Collection Location: At CCSD From Officer Lampkin's Duty Belt
Packaging/Quantity/Item Type: Evidence bag containing - 1 - Portable Radio
Detail Description: One Motorola radio with mic
Owner: City Of Cleveland Division Of Polic
Serial #: 1852462
 H98UCF9PW6AN/
Item Notes:

Process: Hold for investigative purposes

Collection Purpose: Evidence

Item Number: 040

Container #:
Current Custody: Item Submitted Into Property - Evidence Room 1 Drop Chute
Collection Date/Time: 04/15/2021 - 11:03Hrs
Collected By: 44 - Veverka, Steven
Collection Location: At CCSD From Lampkin's Duty Belt
Packaging/Quantity/Item Type: Evidence bag containing - 1 - Taser
Detail Description: One Axon taser yellow in color
Owner: City Of Cleveland Division Of Polic
Serial #: X13007Y9X
 /
Item Notes:

Process: Hold for investigative purposes

Collection Purpose: Evidence

Item Number: 041

Container #:
Current Custody: Item Submitted Into Property - Evidence Room 1 Drop Chute
Collection Date/Time: 04/15/2021 - 11:03Hrs
Collected By: 44 - Veverka, Steven
Collection Location: From Item Number 40
Packaging/Quantity/Item Type: Evidence bag containing - 1 - cartridge(s)
Detail Description: Two Axon Taser cartridges black and green in color
Owner: City Of Cleveland Division Of Polic
Item Notes:

Process: Hold for investigative purposes

Collection Purpose: Evidence

Item Number: 042

Container #:
Current Custody: Item Submitted Into Property - Evidence Room 1 Drop Chute
Collection Date/Time: 04/15/2021 - 11:03Hrs
Collected By: 44 - Veverka, Steven
Collection Location: At CCSD From Officer Lampkin's Duty Belt
Packaging/Quantity/Item Type: Evidence bag containing - 1 - other
Detail Description: Smith and Wesson chain handcuffs
Owner: City Of Cleveland Division Of Polic
Serial #: X47910
 /
Item Notes:

Process: Hold for investigative purposes

Collection Purpose: Evidence

Cuyahoga County Sheriff's Office

Department Case Report

Department Case Number: 21015453

Case Items

Item Number: 043**Container #:****Process:** Hold for investigative purposes**Current Custody:** Item Submitted Into Property - Evidence Room 1 Drop Chute**Collection Date/Time:** 04/15/2021 - 11:03Hrs**Collection Purpose:** Evidence**Collected By:** 44 - Veverka, Steven**Collection Location:** At CCSD From Officer Lampkin's Duty Belt**Packaging/Quantity/Item Type:** Evidence bag containing - 1 - other**Detail Description:** VIPERTEK black hinged handcuffs**Owner:** City Of Cleveland Division Of Polic**Item Notes:****Item Number: 044****Container #:****Process:** Hold for investigative purposes**Current Custody:** Item Submitted Into Property - Evidence Room 1 Drop Chute**Collection Date/Time:** 04/15/2021 - 11:03Hrs**Collection Purpose:** Evidence**Collected By:** 44 - Veverka, Steven**Collection Location:** At CCSD From Officer Lampkin's Duty Belt**Packaging/Quantity/Item Type:** Evidence bag containing - 1 - other**Detail Description:** One Streamlight flashlight**Owner:** City Of Cleveland Division Of Polic**Serial #:** 151645Q1119

/

Item Notes:**Item Number: 045****Container #:****Process:** Hold for investigative purposes**Current Custody:** Item Submitted Into Property - Evidence Room 1 Drop Chute**Collection Date/Time:** 04/15/2021 - 11:03Hrs**Collection Purpose:** Evidence**Collected By:** 44 - Veverka, Steven**Collection Location:** At CCSD From Officer Lampkin**Packaging/Quantity/Item Type:** Evidence bag containing - 1 - handgun**Detail Description:** One black GLOCK 19**Owner:** City Of Cleveland Division Of Polic**Serial #:** BBBE741

/

Weapon Type : P - PISTOL**Weapon Category :** 1 -
SEMI-AUTO(autoloading)**Caliber :** 9mm**Model :** 19**Barrel Length :** 4**Color :** BLK - BLACK**Gun Make :** GLC - Glock, Inc.**Item Notes:****Item Number: 046****Container #:****Process:** Hold for investigative purposes**Current Custody:** Item Submitted Into Property - Evidence Room 1 Drop Chute**Collection Date/Time:** 04/15/2021 - 11:03Hrs**Collection Purpose:** Evidence**Collected By:** 44 - Veverka, Steven**Collection Location:** At CCSD From Lampkin's Duty Belt**Packaging/Quantity/Item Type:** Evidence bag containing - 1 - ammunition**Detail Description:** Magazine with seventeen (17) live rounds**Owner:** City Of Cleveland Division Of Polic**Item Notes:**

Cuyahoga County Sheriff's Office

Department Case Report

Department Case Number: 21015453

Case Items

Item Number: 047

Container #:
Current Custody: Item Submitted Into Property - Evidence Room 1 Drop Chute
Collection Date/Time: 04/15/2021 - 11:03Hrs
Collected By: 44 - Veverka, Steven
Collection Location: At CCSD From Lampkin's Duty Belt
Packaging/Quantity/Item Type: Evidence bag containing - 1 - ammunition
Detail Description: Magazine with sixteen (16) live rounds
Owner: City Of Cleveland Division Of Polic

Process: Hold for investigative purposes**Collection Purpose:** Evidence**Item Notes:****Item Number: 048**

Container #:
Current Custody: Item Submitted Into Property - Evidence Room 1 Drop Chute
Collection Date/Time: 04/15/2021 - 11:03Hrs
Collected By: 44 - Veverka, Steven
Collection Location: At CCSD From Lampkin's Duty Weapon
Packaging/Quantity/Item Type: Evidence bag containing - 1 - ammunition
Detail Description: Magazine with seventeen (17) live rounds
Owner: City Of Cleveland Division Of Polic

Process: Hold for investigative purposes**Collection Purpose:** Evidence**Item Notes:****Item Number: 049**

Container #:
Current Custody: To Lab
Collection Date/Time: 04/15/2021 - 11:03Hrs
Collected By: 44 - Veverka, Steven
Collection Location: At CCSD From Officer Lampkin's Right And Left Hand
Packaging/Quantity/Item Type: Envelope containing - 1 - GSR kit
Detail Description: One gunshot primer residue evidence collection kit
Owner: CLEVELAND POLICE DEPARTMENT

Process: Hold for investigative purposes**Collection Purpose:** Evidence**Item Notes:****Item Number: 050**

Container #:
Current Custody: Item Submitted Into Property - Evidence Room 1 Drop Chute
Collection Date/Time: 04/15/2021 - 11:03Hrs
Collected By: 44 - Veverka, Steven
Collection Location: At CCSD From Lampkin's Duty Weapon
Packaging/Quantity/Item Type: Evidence bag containing - 1 - ammunition
Detail Description: One (1) live 9mm round from chamber of Lampkin's duty weapon.
Owner: City Of Cleveland Division Of Polic

Process: Hold for investigative purposes**Collection Purpose:** Evidence**Item Notes:****Item Number: 051**

Container #:
Current Custody: Item Submitted Into Property - Evidence Room 1 Drop Chute
Collection Date/Time: 04/15/2021 - 11:03Hrs
Collected By: 44 - Veverka, Steven
Collection Location: At CCSD From Officer Lampkin's Duty Vest
Packaging/Quantity/Item Type: Evidence bag containing - 1 - other
Detail Description: One metal handcuff key
Owner: City Of Cleveland Division Of Polic

Process: Hold for investigative purposes**Collection Purpose:** Evidence**Item Notes:**

Cuyahoga County Sheriff's Office

Department Case Report

Department Case Number: 21015453

Case Items

Item Number: 052**Container #:****Process:** Hold for investigative purposes**Current Custody:** Item Submitted Into Property - Evidence Room 1 Drop Chute**Collection Date/Time:** 04/15/2021 - 11:03Hrs**Collection Purpose:** Evidence**Collected By:** 44 - Veverka, Steven**Collection Location:** At CCSD From Officer Lampkin Pocket**Packaging/Quantity/Item Type:** Evidence bag containing - 1 - glove(s)**Detail Description:** Black left hand glove**Owner:** CLEVELAND POLICE DEPARTMENT**Item Notes:****Item Number: 053****Container #:****Process:** Hold for investigative purposes**Current Custody:** Item Submitted Into Property - Evidence Room 1 Drop Chute**Collection Date/Time:** 04/15/2021 - 11:03Hrs**Collection Purpose:** Evidence**Collected By:** 44 - Veverka, Steven**Collection Location:** At CCSD From Officer Lampkin Pocket**Packaging/Quantity/Item Type:** Evidence bag containing - 1 - glove(s)**Detail Description:** Black right hand glove**Owner:** CLEVELAND POLICE DEPARTMENT**Item Notes:****Item Number: 054****Container #:****Process:** Hold for investigative purposes**Current Custody:** Item Submitted Into Property - Evidence Room 1 Drop Chute**Collection Date/Time:** 04/15/2021 - 11:03Hrs**Collection Purpose:** Evidence**Collected By:** 44 - Veverka, Steven**Collection Location:** At CCSD From Officer Lampkin Duty Belt**Packaging/Quantity/Item Type:** Evidence bag containing - 1 - other**Detail Description:** One Crossfire 10% OC spray in 3oz can**Owner:** City Of Cleveland Division Of Polic**Item Notes:****Item Number: 055****Container #:****Process:** Hold for investigative purposes**Current Custody:** Item Submitted Into Property - Evidence Room 1 Drop Chute**Collection Date/Time:** 04/15/2021 - 11:03Hrs**Collection Purpose:** Evidence**Collected By:** 44 - Veverka, Steven**Collection Location:** At CCSD From Officer Lampkin's Person**Packaging/Quantity/Item Type:** Evidence bag containing - 1 - hat**Detail Description:** One skull cap black in color with CPD patch**Owner:** CLEVELAND POLICE DEPARTMENT**Item Notes:****Item Number: 056****Container #:****Process:** Hold for investigative purposes**Current Custody:** Item Submitted Into Property - Evidence Room 1 Drop Chute**Collection Date/Time:** 04/15/2021 - 11:03Hrs**Collection Purpose:** Evidence**Collected By:** 44 - Veverka, Steven**Collection Location:** At CCSD From Officer Lampkin's Duty Vest Pocket**Packaging/Quantity/Item Type:** Evidence bag containing - 1 - knife**Detail Description:** One dark gray Kershaw knife**Owner:** CLEVELAND POLICE DEPARTMENT**Item Notes:**

Cuyahoga County Sheriff's Office Department Case Report

Department Case Number: 21015453

Case Items

Item Number: 057

Container #: **Process:** Hold for investigative purposes
Current Custody: Item Submitted Into Property - Evidence Room 1 Drop Chute
Collection Date/Time: 04/15/2021 - 11:03Hrs **Collection Purpose:** Evidence
Collected By: 44 - Veverka, Steven
Collection Location: At CCSD From Officer Lampkin's Cheek
Packaging/Quantity/Item Type: Envelope containing - 1 - oral swab2
Detail Description: Two Buccal DNA swabs
Owner: CLEVELAND POLICE DEPARTMENT
Item Notes:

Item Number: 058

Container #: **Process:** Hold for investigative purposes
Current Custody: Item Submitted Into Property - Evidence Room 1 Drop Chute
Collection Date/Time: 04/15/2021 - 11:03Hrs **Collection Purpose:** Evidence
Collected By: 44 - Veverka, Steven
Collection Location: At CCSD From Officer Lampkin's Cheek
Packaging/Quantity/Item Type: Envelope containing - 1 - oral swab2
Detail Description: Two Buccal DNA swabs
Owner: CLEVELAND POLICE DEPARTMENT
Item Notes:

Item Number: 059

Container #: **Process:** Hold for investigative purposes
Current Custody: Item Submitted Into Property - Evidence Room 1 Drop Chute
Collection Date/Time: 04/15/2021 - 14:30Hrs **Collection Purpose:** Evidence
Collected By: 86 - Watson, Michael A
Collection Location: COLLECTED FROM BCI AGENT DAN BOERNER .
Packaging/Quantity/Item Type: Evidence bag containing - 1 - other
Detail Description: SILVER HANDCUFFS
Owner: City Of Cleveland Division Of Polic
Item Notes:

Item Number: 060

Container #: **Process:** Hold for investigative purposes
Current Custody: To Lab
Collection Date/Time: 04/15/2021 - 14:30Hrs **Collection Purpose:** Evidence
Collected By: 86 - Watson, Michael A
Collection Location: COLLECTED FROM BCI AGENT DAN BOERNER .
Packaging/Quantity/Item Type: Envelope containing - 1 - cartridge casing(s)
Detail Description: 9MM LUGER CARTRIDGE
Owner: There is no owner associated with this item
Item Notes:

Item Number: 061

Container #: **Process:** Hold for investigative purposes
Current Custody: To Lab
Collection Date/Time: 04/15/2021 - 14:30Hrs **Collection Purpose:** Evidence
Collected By: 86 - Watson, Michael A
Collection Location: COLLECTED FROM BCI AGENT DAN BOERNER .
Packaging/Quantity/Item Type: Envelope containing - 1 - cartridge casing(s)
Detail Description: 9MM LUGER CARTRIDGE
Owner: There is no owner associated with this item
Item Notes:

Cuyahoga County Sheriff's Office

Department Case Report

Department Case Number: 21015453

Case Items

Item Number: 062**Container #:****Process:** Hold for investigative purposes**Current Custody:** To Lab**Collection Date/Time:** 04/15/2021 - 14:30Hrs**Collection Purpose:** Evidence**Collected By:** 86 - Watson, Michael A**Collection Location:** COLLECTED FROM BCI AGENT DAN BOERNER .**Packaging/Quantity/Item Type:** Envelope containing - 1 - cartridge casing(s)**Detail Description:** 9MM LUGER CARTRIDGE**Owner:** There is no owner associated with this item**Item Notes:****Item Number: 063****Container #:****Process:** Hold for investigative purposes**Current Custody:** To Lab**Collection Date/Time:** 04/15/2021 - 14:30Hrs**Collection Purpose:** Evidence**Collected By:** 86 - Watson, Michael A**Collection Location:** COLLECTED FROM BCI AGENT DAN BOERNER .**Packaging/Quantity/Item Type:** Envelope containing - 1 - cartridge casing(s)**Detail Description:** 9MM LUGER CARTRIDGE**Owner:** There is no owner associated with this item**Item Notes:****Item Number: 064****Container #:****Process:** Hold for investigative purposes**Current Custody:** Item Submitted Into Property - Evidence Room 1 Drop Chute**Collection Date/Time:** 04/15/2021 - 14:30Hrs**Collection Purpose:** Evidence**Collected By:** 86 - Watson, Michael A**Collection Location:** COLLECTED FROM BCI AGENT DAN BOERNER .**Packaging/Quantity/Item Type:** Evidence bag containing - 1 - other**Detail Description:** BLACK FIRST AID BAG #400**Owner:** City Of Cleveland Division Of Polic**Item Notes:****Item Number: 065****Container #:****Process:** Hold for investigative purposes**Current Custody:** Item Submitted Into Property - Evidence Room 1 Drop Chute**Collection Date/Time:** 04/15/2021 - 14:30Hrs**Collection Purpose:** Evidence**Collected By:** 86 - Watson, Michael A**Collection Location:** COLLECTED FROM BCI AGENT DAN BOERNER .**Packaging/Quantity/Item Type:** Evidence bag containing - 1 - other**Detail Description:** BLACK FIRST AID BAG #508**Owner:** City Of Cleveland Division Of Polic**Item Notes:****Item Number: 066****Container #:****Process:** Hold for investigative purposes**Current Custody:** Item Submitted Into Property - Evidence Room 1 Drop Chute**Collection Date/Time:** 04/15/2021 - 14:30Hrs**Collection Purpose:** Evidence**Collected By:** 86 - Watson, Michael A**Collection Location:** COLLECTED FROM BCI AGENT DAN BOERNER .**Packaging/Quantity/Item Type:** Jewel Case - 1 - CD/DVD DISC**Detail Description:** DISC CONTAINING PICTURES OF CRIME SCENE**Owner:** There is no owner associated with this item**Item Notes:**

Cuyahoga County Sheriff's Office

Department Case Report

Department Case Number: 21015453

Case Items

Item Number: 067

Container #:

Process: Hold for investigative purposes

Current Custody: Stored in Location - File Cabinet in Evidence Room #1

Collection Date/Time: 04/20/2021 - 10:32Hrs

Collection Purpose: Evidence

Collected By: 191 - Randy Divis

Collection Location:

Packaging/Quantity/Item Type: Evidence bag containing - 1 - CD/DVD DISC

Detail Description: EMS Interview Medic Venczel

Owner: There is no owner associated with this item

Item Notes:

Case Officer Signature

Date

Supervisor Signature

**202100110000 - TRUN - 2M - TROUBLE - UNKNOWN CAUSE - 2M
13617 BEACHWOOD AVE CLEV**

System Comments

Date/Time	Terminal	Operator	
04/15/21 08:04:15	pspd-288	994895	EVENT CREATED - Type: TRUN - 2M - TROUBLE - UNKNOWN CAUSE - 2M, Location: 13617 BEACHWOOD AVE CLEV, Agency: CPD, Group: D4, Beat: 47, Status: P, Priority: 2
04/15/21 08:04:15	pspd-288	994895	INITIAL CALL - Call Source: 1234, Caller Name: S34, Caller Phone Number: , Caller Address:
04/15/21 08:04:15	pspd-288	994895	EVENT REMARK - FM ON THE LINE SUSP ON SCN
04/15/21 08:04:15	ps- cadcom01- v	994895	EVENT REMARK - ** LOI search completed at 04/15/21 08:04:15
04/15/21 08:04:37	pspd-288	994895	EVENT UPDATED - Total Assigned Units: 1,
04/15/21 08:04:37	pspd-288	994895	EVENT UPDATED - First Unit Dispatched Time: 04/15/21 08:04:37, Primary Employee Id: 483, Primary Unit Id: 4A18, Status Code: A,
04/15/21 08:04:37	pspd-288	994895	EVENT UPDATED -
04/15/21 08:04:37	pspd-288	994895	UNIT UPDATED - Unit: 4A18, Status: DP, Location: 13617 BEACHWOOD AVE CLEV, Employees: 483
04/15/21 08:04:39	pspd-288	994895	EVENT UPDATED - Total Assigned Units: 2,
04/15/21 08:04:39	pspd-288	994895	UNIT UPDATED - Unit: 4F17, Status: DP, Location: 13617 BEACHWOOD AVE CLEV, Employees: 505, 994366
04/15/21 08:04:46	\$4F17	994366	EVENT UPDATED - First Unit Enrouted Time: 04/15/21 08:04:46,
04/15/21 08:04:46	\$4F17	994366	UNIT UPDATED - Unit: 4F17, Status: ER, Location: 13617 BEACHWOOD AVE CLEV, Employees: 505, 994366
04/15/21 08:04:53	\$4A18	483	UNIT UPDATED - Unit: 4A18, Status: ER, Location: 13617 BEACHWOOD AVE CLEV, Employees: 483
04/15/21 08:05:31	pspd-288	994895	EVENT REMARK - ML ON FRNT PORCH W/ GRAY HOODIE COVERED UP / NOT SURE IF HE HAS A WPN
04/15/21 08:05:53	pspd-288	994895	EVENT UPDATED - Total Assigned Units: 3,
04/15/21 08:05:53	pspd-288	994895	UNIT UPDATED - Unit: 4A16, Status: DP, Location: 13617 BEACHWOOD AVE CLEV, Employees: 199138, 706181
04/15/21 08:06:02	pspd-288	994895	EVENT REMARK - S34 - REQ TASK FORCE
04/15/21 08:06:20	pspd-288	994895	EVENT REMARK - [REDACTED]
04/15/21 08:06:32	pspd-288	994895	EVENT REMARK - Attachment INNES LEE.JPG was added to event
04/15/21 08:07:04	pspd-288	994895	EVENT REMARK - B37 - HSE IS ON NORTH SIDE OF BEACHWOOD / ML WENT NB WHEN HE RAN EARLIER
04/15/21 08:07:27	\$4A16	199138	UNIT UPDATED - Unit: 4A16, Status: ER, Location: 13617 BEACHWOOD AVE CLEV, Employees: 199138, 706181
04/15/21 08:07:57	pspd-288	994895	EVENT REMARK - CD HAILES ADV
04/15/21 08:08:45	pspd-288	994895	EVENT REMARK - ML LEAVING OFF THE PORCH
04/15/21 08:09:43	pspd-288	994895	EVENT REMARK - ML ON FOOT TWRDS 136TH/BEACHWOOD
04/15/21 08:10:12	pspd-288	994895	EVENT REMARK - POSS K9 / TO HAVE THEM ROLLING THIS WAY IN CASE HE TAKES OFF
04/15/21 08:11:07	pspd-288	994895	UNIT UPDATED - Unit: 4F17, Status: AR, Location: 13617 BEACHWOOD AVE CLEV, Employees: 505, 994366
04/15/21 08:11:08	pspd-288	994895	EVENT UPDATED - First Unit Arrived Time: 04/15/21 08:11:07,
04/15/21 08:11:09	\$4F17	994366	UNIT UPDATED - Unit: 4F17, Status: AR, Location: 13617 BEACHWOOD AVE CLEV, Employees: 505, 994366

04/15/21 08:11:09	\$4F17	994366	UNIT UPDATED - Unit: 4F17, Status: AR, Location: 13617 BEACHWOOD AVE CLEV, Employees: 505, 994366
04/15/21 08:11:10	\$4F17	994366	UNIT UPDATED - Unit: 4F17, Status: AR, Location: 13617 BEACHWOOD AVE CLEV, Employees: 505, 994366
04/15/21 08:11:10	\$4F17	994366	UNIT UPDATED - Unit: 4F17, Status: AR, Location: 13617 BEACHWOOD AVE CLEV, Employees: 505, 994366
04/15/21 08:12:28	pspd-288	994895	UNIT UPDATED - Unit: 4A18, Status: AR, Location: 13617 BEACHWOOD AVE CLEV, Employees: 483
04/15/21 08:12:31	\$4A18	483	UNIT UPDATED - Unit: 4A18, Status: AR, Location: 13617 BEACHWOOD AVE CLEV, Employees: 483
04/15/21 08:12:44	pspd-288	994895	EVENT REMARK - S34 - LS WB ON 136
04/15/21 08:12:49	pspd-288	994895	EVENT REMARK - LIVES ON 134TH
04/15/21 08:13:23	pspd-288	994895	EVENT REMARK - PER OLN 3677 E 147TH
04/15/21 08:14:34	pspd-288	994895	EVENT REMARK - PER LAST NIGHTS CAD // POSS PLT M169281
04/15/21 08:14:56	pspd-288	994895	EVENT REMARK - EXL/1 FULL EXTRADITION
04/15/21 08:15:05	pspd-288	994895	EVENT REMARK - S34 - CK HSES ON E 134TH
04/15/21 08:17:59	pspd-288	994895	EVENT REMARK - S34 - SPEAKING W/ CALLER GAVE LOC 4281 / 4286 E 134
04/15/21 08:18:12	pspd-288	994895	EVENT REMARK - 1 IS A BRN HSE // OR A BLU HSE // UNKWN IF VAC
04/15/21 08:19:47	pspd-288	994895	EVENT UPDATED - Total Assigned Units: 4,
04/15/21 08:19:47	pspd-288	994895	UNIT UPDATED - Unit: 4I77, Status: DP, Location: 13617 BEACHWOOD AVE CLEV, Employees:
04/15/21 08:20:41	pspd-288	994895	EVENT REMARK - I77 - UC GRY IMPALA
04/15/21 08:21:43	pspd-288	994895	EVENT REMARK - 126TH/BEACHWOOD - GRY HOODIE W/ C ON IT // NOT SUSP /MENTALLY DISABLED ML
04/15/21 08:22:38	pspd-288	994895	EVENT REMARK - GARFIELD ADV
04/15/21 08:22:47	pspd-288	994895	EVENT REMARK - CK'ING 4281 // NO 4286
04/15/21 08:22:55	pspd-288	994895	EVENT REMARK - S34 - BRN OR BLU HSE
04/15/21 08:23:15	pspd-288	994895	EVENT REMARK - CK'ING 136TH
04/15/21 08:23:42	pspd-288	994895	EVENT REMARK - ML RUNNING EB JUMPING FENCE
04/15/21 08:23:54	pspd-288	994895	EVENT REMARK - A16 SHOTS FIRED
04/15/21 08:24:03	pspd-288	994895	EVENT UPDATED - Total Assigned Units: 5,
04/15/21 08:24:03	pspd-288	994895	UNIT UPDATED - Unit: 4S13, Status: DP, Location: 13617 BEACHWOOD AVE CLEV, Employees:
04/15/21 08:24:06	pspd-288	994895	EVENT REMARK - SHOTS FIRED ML DOWN
04/15/21 08:24:19	pspd-288	994895	EVENT REMARK - 281 E 134
04/15/21 08:24:33	pspd-288	994895	EVENT REMARK - S13 ALL LATE CARS HEADED THIS WAY
04/15/21 08:24:40	pspd-300	993187	EVENT REMARK - EMS NOTIFIED
04/15/21 08:24:41	pspd-288	994895	EVENT REMARK - 4281 E 134TH
04/15/21 08:25:16	pspd-288	994895	EVENT REMARK - B11
04/15/21 08:25:25	pspd-288	994895	EVENT REMARK - D17

04/15/21 08:25:26	pspd-288	994895	EVENT REMARK - B15
04/15/21 08:25:31	pspd-288	994895	EVENT REMARK - KEEPIGN THE AIR CLEAR
04/15/21 08:25:34	pspd-288	994895	EVENT UPDATED - Total Assigned Units: 6,
04/15/21 08:25:34	pspd-288	994895	UNIT UPDATED - Unit: 4B11, Status: DP, Location: 13617 BEACHWOOD AVE CLEV, Employees:
04/15/21 08:25:49	\$4B11	202104	EVENT REMARK - New equipment list for Unit [4B11] : Device 00037056/MDT/Default System added for employee 202104. Tracking device 00037056/MDT/Default System set. Tracking device 00037056/MDT/Default System set for employee 202104.
04/15/21 08:25:49	\$4B11	202104	UNIT UPDATED - Unit: 4B11, Status: UE, Location: 13617 BEACHWOOD AVE CLEV, Employees: 202104
04/15/21 08:25:50	\$4B11	202104	UNIT UPDATED - Unit: 4B11, Status: UC, Location: 13617 BEACHWOOD AVE CLEV, Employees: 202104
04/15/21 08:25:51	\$4B11	202104	UNIT UPDATED - Unit: 4B11, Status: AM, Location: 13617 BEACHWOOD AVE CLEV, Employees: 202104
04/15/21 08:25:52	\$4B11	202104	UNIT UPDATED - Unit: 4B11, Status: DC, Location: 13617 BEACHWOOD AVE CLEV, Employees: 202104
04/15/21 08:25:53	\$4B11	202104	UNIT UPDATED - Unit: 4B11, Status: DC, Location: 13617 BEACHWOOD AVE CLEV, Employees: 202104
04/15/21 08:25:54	\$4B11	202104	UNIT UPDATED - Unit: 4B11, Status: DC, Location: 13617 BEACHWOOD AVE CLEV, Employees: 202104
04/15/21 08:26:03	\$4B11	202104	UNIT UPDATED - Unit: 4B11, Status: ER, Location: 13617 BEACHWOOD AVE CLEV, Employees: 202104
04/15/21 08:26:10	pspd-288	994895	EVENT UPDATED - Total Assigned Units: 7,
04/15/21 08:26:10	pspd-288	994895	UNIT UPDATED - Unit: 4B15, Status: DP, Location: 13617 BEACHWOOD AVE CLEV, Employees:
04/15/21 08:26:11	pspd-288	994895	EVENT UPDATED - Total Assigned Units: 8,
04/15/21 08:26:11	pspd-288	994895	UNIT UPDATED - Unit: 4D17, Status: DP, Location: 13617 BEACHWOOD AVE CLEV, Employees:
04/15/21 08:26:38	pspd-288	994895	EVENT REMARK - CHEST COMPRESSIONS STARTED
04/15/21 08:26:45	\$4D17	202059	EVENT REMARK - New equipment list for Unit [4D17] : Device 0003713D/MDT/Default System added for employee 202059. Tracking device 0003713D/MDT/Default System set. Tracking device 0003713D/MDT/Default System set for employee 202059.
04/15/21 08:26:45	\$4D17	202059	UNIT UPDATED - Unit: 4D17, Status: UE, Location: 13617 BEACHWOOD AVE CLEV, Employees: 202059
04/15/21 08:26:46	\$4D17	202059	UNIT UPDATED - Unit: 4D17, Status: UC, Location: 13617 BEACHWOOD AVE CLEV, Employees: 202059
04/15/21 08:26:47	\$4D17	202059	UNIT UPDATED - Unit: 4D17, Status: AM, Location: 13617 BEACHWOOD AVE CLEV, Employees: 202059
04/15/21 08:26:48	\$4D17	202059	UNIT UPDATED - Unit: 4D17, Status: DC, Location: 13617 BEACHWOOD AVE CLEV, Employees: 202059
04/15/21 08:26:49	\$4D17	202059	UNIT UPDATED - Unit: 4D17, Status: DC, Location: 13617 BEACHWOOD AVE CLEV, Employees: 202059
04/15/21 08:26:50	\$4D17	202059	UNIT UPDATED - Unit: 4D17, Status: DC, Location: 13617 BEACHWOOD AVE CLEV, Employees: 202059
04/15/21 08:26:54	pspd-289	198832	EVENT REMARK - MED 11 ENR
04/15/21 08:27:00	pspd-289	198832	EVENT REMARK - EMS NO ETA -
04/15/21 08:27:06	pspd-289	198832	EVENT REMARK - ADV OF UPDATES
04/15/21 08:27:09	pspd-288	994895	EVENT REMARK - BACKYARD OF 4281 134

04/15/21 08:27:30	pspd-288	994895	EVENT REMARK - 4281 E 134
04/15/21 08:27:30	pspd-288	994895	UNIT UPDATED - Unit: 4A18, Status: DW, Location: 13617 BEACHWOOD AVE CLEV, Employees: 483
04/15/21 08:27:54	pspd-289	198832	EVENT REMARK - EMS ADV OF LOCATION
04/15/21 08:28:03	pspd-289	198832	EVENT REMARK - NOTIF HOMICIDE NEED SHOOTING TEAM ON SCN
04/15/21 08:28:05	pspd-288	994895	EVENT REMARK - S70 . REQ HOMICIDE NEED SHOOTING TEAM
04/15/21 08:28:12	pspd-289	198832	EVENT REMARK - CD HAILES COPIES
04/15/21 08:28:31	pspd-288	994895	EVENT REMARK - BLOCK 134 / BEACHWOOD & CAINE
04/15/21 08:28:34	pspd-289	198832	EVENT REMARK - BLOCK 134/BEACHWOOD/CAINE
04/15/21 08:28:45	\$4B15	358	EVENT REMARK - Device 0425/GPS Device/Default System added. New equipment list for Unit [4B15] : Device 00037157/MDT/Default System added for employee 358. Tracking device 00037157/MDT/Default System set. Tracking device 00037157/MDT/Default System set for employee 358.
04/15/21 08:28:45	\$4B15	358	UNIT UPDATED - Unit: 4B15, Status: DC, Location: 13617 BEACHWOOD AVE CLEV, Employees:
04/15/21 08:28:46	\$4B15	358	UNIT UPDATED - Unit: 4B15, Status: UE, Location: 13617 BEACHWOOD AVE CLEV, Employees: 358
04/15/21 08:28:47	\$4B15	358	UNIT UPDATED - Unit: 4B15, Status: UC, Location: 13617 BEACHWOOD AVE CLEV, Employees: 358
04/15/21 08:28:48	\$4B15	358	UNIT UPDATED - Unit: 4B15, Status: AM, Location: 13617 BEACHWOOD AVE CLEV, Employees: 358
04/15/21 08:28:48	pspd-289	198832	EVENT REMARK - CONTACT D5 ANED D5 AND D3 FOR CARS
04/15/21 08:28:49	\$4B15	358	UNIT UPDATED - Unit: 4B15, Status: DC, Location: 13617 BEACHWOOD AVE CLEV, Employees: 358
04/15/21 08:28:50	\$4B15	358	UNIT UPDATED - Unit: 4B15, Status: DC, Location: 13617 BEACHWOOD AVE CLEV, Employees: 358
04/15/21 08:28:51	\$4B15	358	UNIT UPDATED - Unit: 4B15, Status: DC, Location: 13617 BEACHWOOD AVE CLEV, Employees: 358
04/15/21 08:28:53	pspd-288	994895	EVENT REMARK - S13 - REQ D5 & D3 TO GET 2 CARS EACH
04/15/21 08:29:17	pspd-289	198832	EVENT REMARK - TO ASSIST WITH BOARD
04/15/21 08:29:18	pspd-288	994895	EVENT REMARK - S50 - REQ 1 CAR FROM D3/D5
04/15/21 08:29:50	pspd-289	198832	EVENT REMARK - D1 AND D2 ADV
04/15/21 08:30:06	pspd-288	994895	EVENT REMARK - S13 - REQ ANY CSU CAR IF SHORT ON CARS
04/15/21 08:30:38	pspd-289	198832	EVENT REMARK - REQ CD FOR PARTNER
04/15/21 08:31:04	pspd-288	994895	EVENT REMARK - S13 - WILL BE WORKING OFF TAC SHORTLY
04/15/21 08:31:12	pspd-289	198832	EVENT REMARK - 26 BLOCKING 134/CAINE
04/15/21 08:31:20	pspd-288	994895	EVENT UPDATED - Total Assigned Units: 9,
04/15/21 08:31:20	pspd-288	994895	UNIT UPDATED - Unit: 4S14, Status: DP, Location: 13617 BEACHWOOD AVE CLEV, Employees:
04/15/21 08:31:21	pspd-289	198832	EVENT REMARK - S14 ON SCN
04/15/21 08:31:21	pspd-288	994895	UNIT UPDATED - Unit: 4S14, Status: AR, Location: 13617 BEACHWOOD AVE CLEV, Employees:
04/15/21 08:31:23	pspd-289	198832	EVENT REMARK - S63 ON SCN
04/15/21 08:31:51	pspd-288	994895	EVENT UPDATED - Total Assigned Units: 10,

04/15/21 08:31:51	pspd-288	994895	UNIT UPDATED - Unit: 4S63, Status: DP, Location: 13617 BEACHWOOD AVE CLEV, Employees:
04/15/21 08:32:36	\$4D17	202059	UNIT UPDATED - Unit: 4D17, Status: ER, Location: 13617 BEACHWOOD AVE CLEV, Employees: 202059
04/15/21 08:32:38	\$4D17	202059	UNIT UPDATED - Unit: 4D17, Status: AR, Location: 13617 BEACHWOOD AVE CLEV, Employees: 202059
04/15/21 08:32:53	pspd-288	994895	UNIT UPDATED - Unit: 4I77, Status: AR, Location: 13617 BEACHWOOD AVE CLEV, Employees:
04/15/21 08:32:56	pspd-288	994895	UNIT UPDATED - Unit: 4S13, Status: AR, Location: 13617 BEACHWOOD AVE CLEV, Employees:
04/15/21 08:33:37	pspd-288	994895	EVENT UPDATED - Total Assigned Units: 11,
04/15/21 08:33:37	pspd-288	994895	UNIT UPDATED - Unit: 4C37, Status: DP, Location: 13617 BEACHWOOD AVE CLEV, Employees: 202035
04/15/21 08:33:51	pspd-288	994895	EVENT UPDATED - Total Assigned Units: 12,
04/15/21 08:33:51	pspd-288	994895	UNIT UPDATED - Unit: 4C16, Status: DP, Location: 13617 BEACHWOOD AVE CLEV, Employees:
04/15/21 08:34:08	pspd-288	994895	EVENT REMARK - 134/CAINE
04/15/21 08:34:08	pspd-288	994895	UNIT UPDATED - Unit: 4C16, Status: DW, Location: 13617 BEACHWOOD AVE CLEV, Employees:
04/15/21 08:34:23	pspd-289	198832	UNIT UPDATED - Unit: 4C37, Status: AR, Location: 13617 BEACHWOOD AVE CLEV, Employees: 202035
04/15/21 08:34:29	pspd-289	198832	UNIT UPDATED - Unit: 4C16, Status: AR, Location: 13617 BEACHWOOD AVE CLEV, Employees:
04/15/21 08:34:42	pspd-288	994895	EVENT UPDATED - Total Assigned Units: 13,
04/15/21 08:34:42	pspd-288	994895	UNIT UPDATED - Unit: 4B17, Status: DP, Location: 13617 BEACHWOOD AVE CLEV, Employees:
04/15/21 08:34:46	pspd-288	994895	UNIT UPDATED - Unit: 4S63, Status: AR, Location: 13617 BEACHWOOD AVE CLEV, Employees:
04/15/21 08:35:30	pspd-300	993187	EVENT REMARK - SAFETY DIRECTOR NOTIFIED
04/15/21 08:35:53	pspd-288	994895	EVENT UPDATED - Total Assigned Units: 14,
04/15/21 08:35:53	pspd-288	994895	UNIT UPDATED - Unit: 4D11, Status: DP, Location: 13617 BEACHWOOD AVE CLEV, Employees:
04/15/21 08:38:03	pspd-288	994895	EVENT UPDATED - Total Assigned Units: 15,
04/15/21 08:38:03	pspd-288	994895	UNIT UPDATED - Unit: 4S12, Status: DP, Location: 13617 BEACHWOOD AVE CLEV, Employees: 993354
04/15/21 08:38:31	pspd-300	993187	EVENT REMARK - GIU/SGT PUTNAM THEY CAN ASSIST IF NEEDED
04/15/21 08:38:41	pspd-289	198832	EVENT UPDATED - Total Assigned Units: 16,
04/15/21 08:38:41	pspd-289	198832	UNIT UPDATED - Unit: 8836, Status: DP, Location: 13617 BEACHWOOD AVE CLEV, Employees:
04/15/21 08:38:42	pspd-289	198832	UNIT UPDATED - Unit: 8836, Status: AR, Location: 13617 BEACHWOOD AVE CLEV, Employees:
04/15/21 08:38:46	pspd-289	198832	EVENT REMARK - 8836 ON SCN
04/15/21 08:38:51	\$4S12	993354	UNIT UPDATED - Unit: 4S12, Status: AR, Location: 13617 BEACHWOOD AVE CLEV, Employees: 993354
04/15/21 08:40:15	pspd-289	198832	EVENT UPDATED - Total Assigned Units: 17,
04/15/21 08:40:15	pspd-289	198832	UNIT UPDATED - Unit: 4S70, Status: DP, Location: 13617 BEACHWOOD AVE CLEV, Employees:
04/15/21 08:40:16	pspd-289	198832	UNIT UPDATED - Unit: 4S70, Status: AR, Location: 13617 BEACHWOOD AVE CLEV, Employees:
04/15/21 08:42:15	\$4B17	825187	EVENT REMARK - Device 0436/GPS Device/Default System added. New equipment list for Unit [4B17] : Device 0003713C/MDT/Default System added for employee 825187. Tracking device 0003713C/MDT/Default System set. Tracking device 0003713C/MDT/Default System set for employee 825187.

04/15/21 08:42:15	\$4B17	825187	UNIT UPDATED - Unit: 4B17, Status: DC, Location: 13617 BEACHWOOD AVE CLEV, Employees: 825187
04/15/21 08:42:16	\$4B17	825187	UNIT UPDATED - Unit: 4B17, Status: UE, Location: 13617 BEACHWOOD AVE CLEV, Employees: 825187
04/15/21 08:42:17	\$4B17	825187	UNIT UPDATED - Unit: 4B17, Status: UC, Location: 13617 BEACHWOOD AVE CLEV, Employees: 825187
04/15/21 08:42:18	\$4B17	825187	UNIT UPDATED - Unit: 4B17, Status: AM, Location: 13617 BEACHWOOD AVE CLEV, Employees: 825187
04/15/21 08:42:19	\$4B17	825187	UNIT UPDATED - Unit: 4B17, Status: DC, Location: 13617 BEACHWOOD AVE CLEV, Employees: 825187
04/15/21 08:42:20	\$4B17	825187	UNIT UPDATED - Unit: 4B17, Status: DC, Location: 13617 BEACHWOOD AVE CLEV, Employees: 825187
04/15/21 08:42:21	\$4B17	825187	UNIT UPDATED - Unit: 4B17, Status: DC, Location: 13617 BEACHWOOD AVE CLEV, Employees: 825187
04/15/21 08:44:32	pspd-288	994895	EVENT UPDATED - Total Assigned Units: 18,
04/15/21 08:44:32	pspd-288	994895	UNIT UPDATED - Unit: 4D18, Status: DP, Location: 13617 BEACHWOOD AVE CLEV, Employees: 994895
04/15/21 08:45:38	pspd-289	198832	EVENT REMARK - 4A18 PRIMARY
04/15/21 08:45:51	pspd-300	993187	EVENT REMARK - HOMICIDE NOTIFIED AND RESPONDING
04/15/21 08:45:53	\$4D11	990964	EVENT REMARK - New equipment list for Unit [4D11] : Device 0003713A/MDT/Default System added for employee 990964. Tracking device 0003713A/MDT/Default System set. Tracking device 0003713A/MDT/Default System set for employee 990964.
04/15/21 08:45:53	\$4D11	990964	UNIT UPDATED - Unit: 4D11, Status: UE, Location: 13617 BEACHWOOD AVE CLEV, Employees: 990964
04/15/21 08:45:54	\$4D11	990964	UNIT UPDATED - Unit: 4D11, Status: UC, Location: 13617 BEACHWOOD AVE CLEV, Employees: 990964
04/15/21 08:45:55	\$4D11	990964	UNIT UPDATED - Unit: 4D11, Status: AM, Location: 13617 BEACHWOOD AVE CLEV, Employees: 990964
04/15/21 08:45:56	\$4D11	990964	UNIT UPDATED - Unit: 4D11, Status: DC, Location: 13617 BEACHWOOD AVE CLEV, Employees: 990964
04/15/21 08:45:57	\$4D11	990964	UNIT UPDATED - Unit: 4D11, Status: DC, Location: 13617 BEACHWOOD AVE CLEV, Employees: 990964
04/15/21 08:45:58	\$4D11	990964	UNIT UPDATED - Unit: 4D11, Status: DC, Location: 13617 BEACHWOOD AVE CLEV, Employees: 990964
04/15/21 08:46:45	pspd-289	198832	EVENT REMARK - 4S14 -- KEEPING 4A18 HERE-4B17 HERE 4B17 4C16 AND 4B15 FOR NOW- NO OTHER CARS NEEDED AT THIS TIME
04/15/21 08:46:46	pspd-289	198832	UNIT UPDATED - Unit: 4S14, Status: EC, Location: 13617 BEACHWOOD AVE CLEV, Employees: 198832
04/15/21 08:46:56	pspd-289	198832	EVENT REMARK - AND 4A16
04/15/21 08:47:18	pspd-300	993187	EVENT REMARK - SIU NOTIFIED AND RESPONDING
04/15/21 08:48:12	\$4D11	990964	UNIT UPDATED - Unit: 4D11, Status: ER, Location: 13617 BEACHWOOD AVE CLEV, Employees: 990964
04/15/21 08:48:38	pspd-289	198832	EVENT UPDATED -
04/15/21 08:48:38	ps-cadcom01-v	198832	EVENT REMARK - ** VEH search completed at 04/15/21 08:48:38
04/15/21 08:48:38	pspd-289	198832	ADD SUPPLEMENTAL- Revision Number: 1, Supplemental Type: Vehicle, UnitId: 4C16
04/15/21 08:48:41	\$4B17	825187	EVENT REMARK - Vehicle Code is: 2p5318/17490
04/15/21 08:48:41	\$4B17	825187	UNIT UPDATED - Unit: 4B17, Status: UC, Location: 13617 BEACHWOOD AVE CLEV, Employees: 825187
04/15/21	\$4B17	825187	EVENT REMARK - s d r 360 no fresh / wcs 0634 2072 / dfsm 93056 dfsd 8-5-21 /

08:48:42			New equipment list for Unit [4B17] : AB437:1, SGD560560M:1
04/15/21 08:48:42	\$4B17	825187	UNIT UPDATED - Unit: 4B17, Status: UU, Location: 13617 BEACHWOOD AVE CLEV, Employees: 825187
04/15/21 08:48:43	\$4B17	825187	UNIT UPDATED - Unit: 4B17, Status: UE, Location: 13617 BEACHWOOD AVE CLEV, Employees: 199160, 825187
04/15/21 08:48:44	\$4B17	825187	UNIT UPDATED - Unit: 4B17, Status: UC, Location: 13617 BEACHWOOD AVE CLEV, Employees: 199160, 825187
04/15/21 08:49:42	pspd-289	198832	EVENT REMARK - 4D11 RESP AND HANDLING CRIME SCN LOG
04/15/21 08:49:42	pspd-288	994895	EVENT REMARK - D11 TO RELIEVE C37
04/15/21 08:49:54	\$4B17	825187	EVENT UPDATED - Total Assigned Units: 17,
04/15/21 08:49:54	\$4B17	825187	EVENT REMARK - assisted wcs-1
04/15/21 08:49:54	\$4B17	825187	DISPOSITION ASSIGNED - ASST
04/15/21 08:49:54	\$4B17	825187	UNIT UPDATED - Unit: 4B17, Status: AM, Location: , Employees: 199160, 825187
04/15/21 08:51:16	pspd-288	994895	EVENT UPDATED - Total Assigned Units: 16,
04/15/21 08:51:16	pspd-288	994895	DISPOSITION ASSIGNED - ASST
04/15/21 08:51:16	pspd-288	994895	UNIT UPDATED - Unit: 4S12, Status: AM, Location: , Employees: 993354
04/15/21 08:51:25	pspd-289	198832	EVENT REMARK - 4S12 COMP- PERIMETERS ESTABLISHED
04/15/21 08:52:04	pspd-288	994895	EVENT UPDATED - Total Assigned Units: 17,
04/15/21 08:52:04	pspd-288	994895	UNIT UPDATED - Unit: 4S50, Status: DP, Location: 13617 BEACHWOOD AVE CLEV, Employees:
04/15/21 08:53:11	pspd-300	993187	EVENT REMARK - PER EMS THIS FATAL SHOOTING
04/15/21 08:53:21	pspd-300	993187	EVENT REMARK - NOTIFYING THE CCSO
04/15/21 08:55:13	\$4D11	990964	EVENT REMARK - Vehicle Code is: 5p0585/14802
04/15/21 08:55:13	\$4D11	990964	UNIT UPDATED - Unit: 4D11, Status: UC, Location: 13617 BEACHWOOD AVE CLEV, Employees: 990964
04/15/21 08:55:15	\$4D11	990964	EVENT REMARK - no new damage dfsd 07-03-21 dfsm 125657 tour of duty 0800-1600 New equipment list for Unit [4D11] : SGC983588M:1, AB451:1, FAK473:1
04/15/21 08:55:15	\$4D11	990964	UNIT UPDATED - Unit: 4D11, Status: UU, Location: 13617 BEACHWOOD AVE CLEV, Employees: 990964
04/15/21 08:55:16	\$4D11	990964	UNIT UPDATED - Unit: 4D11, Status: UC, Location: 13617 BEACHWOOD AVE CLEV, Employees: 990964
04/15/21 08:58:51	pspd-288	994895	EVENT REMARK - D18 - RESIDENT OF THE 1ST WHI HSE // OK TO LET HER IN // S14 OK TO KEEP AN EYE
04/15/21 09:00:12	\$4B11	202104	EVENT REMARK - Tracking device 00037056/MDT/Default System cleared. Tracking device 00037056/MDT/Default System set. New equipment list for Unit [4B11] :
04/15/21 09:00:12	\$4B11	202104	UNIT UPDATED - Unit: 4B11, Status: DC, Location: 13617 BEACHWOOD AVE CLEV, Employees: 202104
04/15/21 09:00:13	\$4B11	202104	UNIT UPDATED - Unit: 4B11, Status: DC, Location: 13617 BEACHWOOD AVE CLEV, Employees: 202104
04/15/21 09:00:14	\$4B11	202104	UNIT UPDATED - Unit: 4B11, Status: UC, Location: 13617 BEACHWOOD AVE CLEV, Employees: 202104
04/15/21 09:00:49	\$4D11	990964	UNIT UPDATED - Unit: 4D11, Status: AR, Location: 13617 BEACHWOOD AVE CLEV, Employees: 990964
04/15/21 09:02:32	pspd-300	993187	EVENT REMARK - CCSO NOTIFIED

04/15/21 09:04:13	pspd-289	198832	EVENT REMARK - REQ TO NOTIFY RESD AND TO MAKE SURE EVERYONE IS OK
04/15/21 09:05:20	pspd-288	994895	EVENT REMARK - ANOTHER CALL FROM RTCC \
04/15/21 09:05:56	pspd-300	993187	EVENT REMARK - CCSO TO NOTIFY BCI ALSO
04/15/21 09:06:22	pspd-288	994895	EVENT REMARK - CONF W/ LOWTHER #2367
04/15/21 09:06:39	pspd-300	993187	EVENT REMARK - UNIONS (ALL) NOTIFIED
04/15/21 09:09:27	pspd-289	198832	EVENT REMARK - 2 UC UNITS IN THE AREA TO ASSIST WITH MONITORING THE AREA
04/15/21 09:09:30	pspd-289	198832	EVENT UPDATED - Total Assigned Units: 18,
04/15/21 09:09:30	pspd-289	198832	UNIT UPDATED - Unit: 9837, Status: DP, Location: 13617 BEACHWOOD AVE CLEV, Employees:
04/15/21 09:09:31	pspd-289	198832	UNIT UPDATED - Unit: 9837, Status: AR, Location: 13617 BEACHWOOD AVE CLEV, Employees:
04/15/21 09:09:48	pspd-288	994895	EVENT UPDATED - Total Assigned Units: 17,
04/15/21 09:09:48	pspd-288	994895	DISPOSITION ASSIGNED - ASST
04/15/21 09:09:48	pspd-288	994895	UNIT UPDATED - Unit: 4C37, Status: AM, Location: , Employees: 202035
04/15/21 09:11:39	\$4B11	202104	EVENT REMARK - Vehicle Code is: 2p5256, 17436
04/15/21 09:11:39	\$4B11	202104	UNIT UPDATED - Unit: 4B11, Status: UC, Location: 13617 BEACHWOOD AVE CLEV, Employees: 202104
04/15/21 09:11:40	\$4B11	202104	EVENT REMARK - 4/15/21, tod 0800-1600, 360 dents rust and scratches, dfsd 7/2/21, dfsm 126019, wcs 4979 and 0595 New equipment list for Unit [4B11] : AB407:1, W675020M:1, FAK679:1
04/15/21 09:11:40	\$4B11	202104	UNIT UPDATED - Unit: 4B11, Status: UU, Location: 13617 BEACHWOOD AVE CLEV, Employees: 202104
04/15/21 09:11:41	\$4B11	202104	UNIT UPDATED - Unit: 4B11, Status: UE, Location: 13617 BEACHWOOD AVE CLEV, Employees: 458, 202104
04/15/21 09:11:42	\$4B11	202104	UNIT UPDATED - Unit: 4B11, Status: UC, Location: 13617 BEACHWOOD AVE CLEV, Employees: 458, 202104
04/15/21 09:11:46	pspd-288	994895	UNIT UPDATED - Unit: 4D18, Status: AR, Location: 13617 BEACHWOOD AVE CLEV, Employees:
04/15/21 09:12:03	pspd-288	994895	EVENT REMARK - D18 - ANOTHER RESIDENT LIVES 2 DOORS DOWN, REQ OK TO ESCORT / S14 OK
04/15/21 09:13:55	pspd-288	994895	EVENT REMARK - S13 - FRIENDS COMING ON SCN
04/15/21 09:13:58	pspd-289	198832	EVENT REMARK - HAVE SOME FRIENDS SHOWING UP ON SCN
04/15/21 09:14:15	pspd-289	198832	EVENT UPDATED - Total Assigned Units: 18,
04/15/21 09:14:15	pspd-289	198832	UNIT UPDATED - Unit: 8840, Status: DP, Location: 13617 BEACHWOOD AVE CLEV, Employees:
04/15/21 09:14:16	pspd-289	198832	UNIT UPDATED - Unit: 8840, Status: AR, Location: 13617 BEACHWOOD AVE CLEV, Employees:
04/15/21 09:14:19	pspd-289	198832	EVENT REMARK - 8840 COPIES
04/15/21 09:14:55	pspd-289	198832	EVENT REMARK - AT THE SOUTH END OF 134 WHERE THE MEDIA IS
04/15/21 09:15:43	pspd-289	198832	EVENT REMARK - BEACHWOOD SIDE**
04/15/21 09:16:18	pspd-288	994895	EVENT REMARK - D18 - COMMUNITY RELATIONS ON SCN
04/15/21 09:20:15	pspd-288	994895	EVENT REMARK - F17 - ML IN BLU & PINK HOODIE/ BLU JNS IS ACROSS THE STREET ON 134
04/15/21 09:21:32	pspd-288	994895	EVENT REMARK - S14 - EVERYONE ADV TO TAC
04/15/21 09:23:19	pspd-289	198832	EVENT REMARK - 4S14 -- WILL NEED ANOTHER CAR--TO GO DOWN 136 TO MAKE SURE NOBODY COMES OVER

04/15/21 09:23:20	pspd-289	198832	UNIT UPDATED - Unit: 4S14, Status: EC, Location: 13617 BEACHWOOD AVE CLEV, Employees:
04/15/21 09:23:27	pspd-289	198832	EVENT REMARK - 4B11 ON 136
04/15/21 09:26:31	\$4G14	2512	EVENT UPDATED - Total Assigned Units: 19,
04/15/21 09:26:31	\$4G14	2512	UNIT UPDATED - Unit: 4G14, Status: DP, Location: 13617 BEACHWOOD AVE CLEV, Employees: 2512
04/15/21 09:27:42	\$4G14	2512	UNIT UPDATED - Unit: 4G14, Status: ER, Location: 13617 BEACHWOOD AVE CLEV, Employees: 2512
04/15/21 09:29:06	pspd-289	198832	EVENT REMARK - 4B15 ON 136
04/15/21 09:29:19	pspd-289	198832	EVENT REMARK - PIT BULL HEADED TOWARDS OFFICERS- HE FRIENDLY
04/15/21 09:31:21	pspd-289	198832	EVENT REMARK - 4B15 ON SCN- BUT DOES NOT HAVE THEIR CAR-
04/15/21 09:40:34	pspd-289	198832	EVENT REMARK - 4B11 -- TO STAY ON 136 PER 5S14- 4B15 TO PATROL FOR CROWDS
04/15/21 09:40:35	pspd-289	198832	UNIT UPDATED - Unit: 4B11, Status: EC, Location: 13617 BEACHWOOD AVE CLEV, Employees: 458, 202104
04/15/21 09:40:47	pspd-289	198832	EVENT REMARK - CORR*** 4S14
04/15/21 09:42:35	\$4B15	358	EVENT REMARK - Vehicle Code is: 2p5315/17826
04/15/21 09:42:35	\$4B15	358	EVENT REMARK - tod:0800-1600 360 dsr no new damage dfsd 8-13-21 dfsm 86827 wcs 9381/1376 partner p.o. huskey jr #2121 New equipment list for Unit [4B15] : AB453:1, SGW539545M:1, FAK389:1
04/15/21 09:42:35	\$4B15	358	UNIT UPDATED - Unit: 4B15, Status: UC, Location: 13617 BEACHWOOD AVE CLEV, Employees: 358
04/15/21 09:42:35	\$4B15	358	UNIT UPDATED - Unit: 4B15, Status: UU, Location: 13617 BEACHWOOD AVE CLEV, Employees: 358
04/15/21 09:42:36	\$4B15	358	UNIT UPDATED - Unit: 4B15, Status: UC, Location: 13617 BEACHWOOD AVE CLEV, Employees: 358
04/15/21 09:44:01	pspd-288	994895	EVENT REMARK - S34 - FACEBOOK LIVE HAS IT ON THE NEWS / REQ TO STOP TALKING
04/15/21 09:44:18	pspd-288	994895	EVENT REMARK - BCST OVER TAC
04/15/21 09:47:06	pspd-290	990283	EVENT REMARK - 8836 CONF W/ OWNER
04/15/21 09:47:34	pspd-288	994895	EVENT UPDATED - Total Assigned Units: 18,
04/15/21 09:47:34	pspd-288	994895	DISPOSITION ASSIGNED - ASST
04/15/21 09:47:34	pspd-288	994895	UNIT UPDATED - Unit: 4S13, Status: AV, Location: , Employees:
04/15/21 09:47:40	pspd-290	990283	UNIT UPDATED - Unit: 8836, Status: UV, Location: 13617 BEACHWOOD AVE CLEV, Employees:
04/15/21 09:47:41	pspd-290	990283	EVENT REMARK - New equipment list for Unit [8836] :
04/15/21 09:47:41	pspd-290	990283	UNIT UPDATED - Unit: 8836, Status: UC, Location: 13617 BEACHWOOD AVE CLEV, Employees:
04/15/21 09:48:48	pspd-289	198832	EVENT REMARK - ALL CARS ADV THAT THIS IS BEING RECORDED ON FB LIVE
04/15/21 09:51:30	pspd-289	198832	EVENT REMARK - PER 4S59- EVERYTHING BEING BROADCASTED IS BEING PICKED UP BY MEDIA MICS
04/15/21 09:54:14	pspd-289	198832	EVENT REMARK - 4S14 -- 4B15- MAKE SURE TO GO DOWN 133 TO SEE IF ANY SHERIFFS ARE ON THAT STREET- DONT WANT ANYONE COMING FROM BEHIND
04/15/21 09:54:15	pspd-289	198832	UNIT UPDATED - Unit: 4S14, Status: EC, Location: 13617 BEACHWOOD AVE CLEV, Employees:
04/15/21 09:55:01	pspd-289	198832	EVENT REMARK - 4B15 -- THERE ARE 2 SHERIFFS CARS ON 133
04/15/21 09:55:02	pspd-289	198832	UNIT UPDATED - Unit: 4B15, Status: EC, Location: 13617 BEACHWOOD AVE CLEV, Employees: 358

04/15/21 10:08:08	psct-267	202514	EVENT REMARK - ** LOI information for Event # 202100110000 was viewed at: 04/15/21 10:08:08 ** >>> by: MICHAEL R. MAEHLER on terminal: psct-267
04/15/21 10:08:32	pspd-289	198832	EVENT REMARK - 4B11 -- NO SHERIFFS ON 136
04/15/21 10:08:33	pspd-289	198832	UNIT UPDATED - Unit: 4B11, Status: EC, Location: 13617 BEACHWOOD AVE CLEV, Employees: 458, 202104
04/15/21 10:09:06	pspd-289	198832	EVENT REMARK - 4S14 -- 4B11 GO TO 135 TO MAKE SURE THERE ARE SHERIFFS WITH THE 1 MANS
04/15/21 10:09:07	pspd-289	198832	UNIT UPDATED - Unit: 4S14, Status: EC, Location: 13617 BEACHWOOD AVE CLEV, Employees:
04/15/21 10:10:52	pspd-289	198832	EVENT REMARK - CHIEF ON SCN
04/15/21 10:12:34	pspd-289	198832	EVENT REMARK - 4S14 -- 4B15 2 SHERIFFS ON 133- 1 SHERIFFS ON 134 AND A SHERIFF WITH THE 1 MAN ON 134/BEACHWOOD AS WELL AS THE OTHER SIDE
04/15/21 10:12:35	pspd-289	198832	UNIT UPDATED - Unit: 4S14, Status: EC, Location: 13617 BEACHWOOD AVE CLEV, Employees:
04/15/21 10:16:11	pspd-289	198832	EVENT REMARK - 4S14 -- WILL HAVE SHERIFFS GO TO 136 AND FREE UP 4B11- ALSO 4C16 IS FREED UP
04/15/21 10:16:12	pspd-289	198832	UNIT UPDATED - Unit: 4S14, Status: EC, Location: 13617 BEACHWOOD AVE CLEV, Employees:
04/15/21 10:21:27	\$4B11	202104	EVENT UPDATED - Total Assigned Units: 17,
04/15/21 10:21:27	\$4B11	202104	EVENT REMARK - info rec, assisted setting perimeter of house behind crime scene on E136, relieved by sheriff's per 4S14, WCS 1
04/15/21 10:21:27	\$4B11	202104	DISPOSITION ASSIGNED - INFO
04/15/21 10:21:27	\$4B11	202104	DISPOSITION ASSIGNED - ASST
04/15/21 10:21:27	\$4B11	202104	UNIT UPDATED - Unit: 4B11, Status: AM, Location: , Employees: 458, 202104
04/15/21 10:23:39	\$4B15	358	EVENT UPDATED - Total Assigned Units: 16,
04/15/21 10:23:39	\$4B15	358	EVENT REMARK - asst with crime scene security, wcs1
04/15/21 10:23:39	\$4B15	358	DISPOSITION ASSIGNED - ASST
04/15/21 10:23:39	\$4B15	358	UNIT UPDATED - Unit: 4B15, Status: AM, Location: , Employees: 358
04/15/21 10:24:51	pspd-289	198832	EVENT REMARK - 4D18 -- ESCORTING RESD 4269 E 139- OK PER 4S14
04/15/21 10:24:52	pspd-289	198832	UNIT UPDATED - Unit: 4D18, Status: EC, Location: 13617 BEACHWOOD AVE CLEV, Employees:
04/15/21 10:27:56	pspd-283	996482	EVENT REMARK - 8836 - ENR TO JUSTICE CENTER WITH LAMPKIN TO SHERIFFS OFFICE FROM 4A18
04/15/21 10:43:04	\$4C16	993423	EVENT REMARK - New equipment list for Unit [4C16] : Device 00037183/MDT/Default System added for employee 993423. Tracking device 00037183/MDT/Default System set. Tracking device 00037183/MDT/Default System set for employee 993423.
04/15/21 10:43:04	\$4C16	993423	UNIT UPDATED - Unit: 4C16, Status: UE, Location: 13617 BEACHWOOD AVE CLEV, Employees: 993423
04/15/21 10:43:05	\$4C16	993423	UNIT UPDATED - Unit: 4C16, Status: UC, Location: 13617 BEACHWOOD AVE CLEV, Employees: 993423
04/15/21 10:43:06	\$4C16	993423	UNIT UPDATED - Unit: 4C16, Status: AM, Location: 13617 BEACHWOOD AVE CLEV, Employees: 993423
04/15/21 10:43:07	\$4C16	993423	UNIT UPDATED - Unit: 4C16, Status: DC, Location: 13617 BEACHWOOD AVE CLEV, Employees: 993423
04/15/21 10:43:08	\$4C16	993423	UNIT UPDATED - Unit: 4C16, Status: DC, Location: 13617 BEACHWOOD AVE CLEV, Employees: 993423
04/15/21	\$4C16	993423	UNIT UPDATED - Unit: 4C16, Status: DC, Location: 13617 BEACHWOOD AVE CLEV, Employees:

10:43:09			993423	
04/15/21 10:43:15	pspd-283	996482		EVENT REMARK - 9837 - LEAVING THE AREA
04/15/21 10:43:25	pspd-283	996482		EVENT UPDATED - Total Assigned Units: 15,
04/15/21 10:43:25	pspd-283	996482		DISPOSITION ASSIGNED - ASST
04/15/21 10:43:25	pspd-283	996482		UNIT UPDATED - Unit: 9837, Status: AV, Location: , Employees:
04/15/21 10:43:55	\$4C16	993423		UNIT UPDATED - Unit: 4C16, Status: AK, Location: 13617 BEACHWOOD AVE CLEV, Employees: 993423
04/15/21 10:43:56	\$4C16	993423		UNIT UPDATED - Unit: 4C16, Status: AR, Location: 13617 BEACHWOOD AVE CLEV, Employees: 993423
04/15/21 10:44:23	pspd-288	994895		EVENT REMARK - @2512 - FEW3 FAMILY MEMBERS PULLING UP ON 134
04/15/21 10:44:48	pspd-283	996482		EVENT REMARK - 4D18 - SMALL NUMBER OF FAMILY GATHERING 134/CAINE
04/15/21 10:50:44	pspd-297	994423		EVENT REMARK - ** LOI information for Event # 202100110000 was viewed at: 04/15/21 10:50:44 ** >>> by: JACQUELINE MIZIKAR on terminal: pspd-297
04/15/21 10:53:56	pspd-289	198832		EVENT REMARK - 4D18 -- GENTLEMAN- CLAIMING TO BE A PARENT WANTING TO SPEAK TO A HOMICIDE DETECTIVE- 4S14 WILL LET HIM KNOW
04/15/21 10:53:57	pspd-289	198832		UNIT UPDATED - Unit: 4D18, Status: EC, Location: 13617 BEACHWOOD AVE CLEV, Employees:
04/15/21 11:04:09	pspd-288	994895		EVENT REMARK - ER D4
04/15/21 11:04:09	pspd-288	994895		UNIT UPDATED - Unit: 4A18, Status: DW, Location: 13617 BEACHWOOD AVE CLEV, Employees: 483
04/15/21 11:04:23	pspd-289	198832		EVENT REMARK - 4S14 REQ 4O11 AND 4O13 TO RESP TO 134/CAINE TO ASST WITH FAMILY
04/15/21 11:04:33	pspd-289	198832		EVENT UPDATED - Total Assigned Units: 16,
04/15/21 11:04:33	pspd-289	198832		UNIT UPDATED - Unit: 4O11, Status: DP, Location: 13617 BEACHWOOD AVE CLEV, Employees: 994674
04/15/21 11:08:37	pspd-289	198832		EVENT UPDATED - Total Assigned Units: 17,
04/15/21 11:08:37	pspd-289	198832		UNIT UPDATED - Unit: 4O13, Status: DP, Location: 13617 BEACHWOOD AVE CLEV, Employees:
04/15/21 11:11:29	pspd-289	198832		EVENT REMARK - SHERIFFS CARS ON 133- HANDLING PERIMETER
04/15/21 11:13:12	\$4O11	994674		UNIT UPDATED - Unit: 4O11, Status: ER, Location: 13617 BEACHWOOD AVE CLEV, Employees: 994674
04/15/21 11:15:21	\$4A18	483		EVENT REMARK - Tracking device 00037138/MDT/Default System cleared. Tracking device 00037138/MDT/Default System set. New equipment list for Unit [4A18] :
04/15/21 11:15:21	\$4A18	483		UNIT UPDATED - Unit: 4A18, Status: DC, Location: 13617 BEACHWOOD AVE CLEV, Employees: 483
04/15/21 11:15:22	\$4A18	483		UNIT UPDATED - Unit: 4A18, Status: DC, Location: 13617 BEACHWOOD AVE CLEV, Employees: 483
04/15/21 11:15:23	\$4A18	483		UNIT UPDATED - Unit: 4A18, Status: UC, Location: 13617 BEACHWOOD AVE CLEV, Employees: 483
04/15/21 11:20:48	\$4O11	994674		UNIT UPDATED - Unit: 4O11, Status: AR, Location: 13617 BEACHWOOD AVE CLEV, Employees: 994674
04/15/21 11:20:49	\$4O11	994674		UNIT UPDATED - Unit: 4O11, Status: AR, Location: 13617 BEACHWOOD AVE CLEV, Employees: 994674
04/15/21 11:23:57	\$4C16	993423		EVENT REMARK - Tracking device 00037183/MDT/Default System cleared. Tracking device 00037183/MDT/Default System set. New equipment list for Unit [4C16] :
04/15/21 11:23:57	\$4C16	993423		UNIT UPDATED - Unit: 4C16, Status: DC, Location: 13617 BEACHWOOD AVE CLEV, Employees: 993423

04/15/21 11:23:58	\$4C16	993423	UNIT UPDATED - Unit: 4C16, Status: DC, Location: 13617 BEACHWOOD AVE CLEV, Employees: 993423
04/15/21 11:23:59	\$4C16	993423	UNIT UPDATED - Unit: 4C16, Status: UC, Location: 13617 BEACHWOOD AVE CLEV, Employees: 993423
04/15/21 12:00:12	pspd-288	994895	EVENT UPDATED - Total Assigned Units: 16,
04/15/21 12:00:12	pspd-288	994895	EVENT REMARK - ASST
04/15/21 12:00:12	pspd-288	994895	DISPOSITION ASSIGNED - ASST
04/15/21 12:00:12	pspd-288	994895	UNIT UPDATED - Unit: 4S50, Status: AV, Location: , Employees:
04/15/21 12:17:07	\$4O11	994674	EVENT UPDATED - Total Assigned Units: 15,
04/15/21 12:17:07	\$4O11	994674	DISPOSITION ASSIGNED - COMP
04/15/21 12:17:07	\$4O11	994674	UNIT UPDATED - Unit: 4O11, Status: AM, Location: , Employees: 994674
04/15/21 12:17:08	\$4O11	994674	EVENT REMARK - confer with victim from homicide family,chief, commander, assisted 4A18, wcs 1 comp
04/15/21 12:31:35	\$4D17	202059	EVENT REMARK - Vehicle Code is: 14853/002p5128
04/15/21 12:31:35	\$4D17	202059	UNIT UPDATED - Unit: 4D17, Status: UC, Location: 13617 BEACHWOOD AVE CLEV, Employees: 202059
04/15/21 12:31:36	\$4D17	202059	EVENT REMARK - dsr wear and tear 360, dfsd 6/9/21, dfsm 164220, tour 4/15/21 0800-1600, wcs 0060 New equipment list for Unit [4D17] : AB414:1, SGV909842V:1, FAK233:1
04/15/21 12:31:36	\$4D17	202059	UNIT UPDATED - Unit: 4D17, Status: UU, Location: 13617 BEACHWOOD AVE CLEV, Employees: 202059
04/15/21 12:31:37	\$4D17	202059	UNIT UPDATED - Unit: 4D17, Status: UC, Location: 13617 BEACHWOOD AVE CLEV, Employees: 202059
04/15/21 12:32:27	\$4D11	990964	EVENT REMARK - Tracking device 0003713A/MDT/Default System cleared. Tracking device 0003713A/MDT/Default System set. New equipment list for Unit [4D11] :
04/15/21 12:32:27	\$4D11	990964	UNIT UPDATED - Unit: 4D11, Status: DC, Location: 13617 BEACHWOOD AVE CLEV, Employees: 990964
04/15/21 12:32:28	\$4D11	990964	UNIT UPDATED - Unit: 4D11, Status: DC, Location: 13617 BEACHWOOD AVE CLEV, Employees: 990964
04/15/21 12:32:29	\$4D11	990964	UNIT UPDATED - Unit: 4D11, Status: UC, Location: 13617 BEACHWOOD AVE CLEV, Employees: 990964
04/15/21 12:32:41	\$4D11	990964	UNIT UPDATED - Unit: 4D11, Status: AR, Location: 13617 BEACHWOOD AVE CLEV, Employees: 990964
04/15/21 13:21:29	pspd-288	994895	EVENT UPDATED - Total Assigned Units: 14,
04/15/21 13:21:29	pspd-288	994895	DISPOSITION ASSIGNED - ASST
04/15/21 13:21:29	pspd-288	994895	UNIT UPDATED - Unit: 4O13, Status: AV, Location: , Employees:
04/15/21 13:29:40	pspd-288	994895	EVENT UPDATED - Total Assigned Units: 13,
04/15/21 13:29:40	pspd-288	994895	EVENT REMARK - ASST
04/15/21 13:29:40	pspd-288	994895	DISPOSITION ASSIGNED - ASST
04/15/21 13:29:40	pspd-288	994895	UNIT UPDATED - Unit: 4D11, Status: AM, Location: , Employees: 990964
04/15/21 13:40:06	pspd-288	994895	EVENT REMARK - PER S14 - KEEP THINGS ON TAC UNTIL OTHER WISE MENTIONED
04/15/21 14:20:08	pspd-288	994895	EVENT REMARK - Delete Dispatch Warning
04/15/21 14:20:08	pspd-288	994895	UNIT UPDATED - Unit: 4A18, Status: DW, Location: 13617 BEACHWOOD AVE CLEV, Employees: 483

04/15/21 14:20:48	pspd-288	994895	EVENT UPDATED - Total Assigned Units: 12,
04/15/21 14:20:48	pspd-288	994895	EVENT REMARK - RH DNCB
04/15/21 14:20:48	pspd-288	994895	DISPOSITION ASSIGNED - RH
04/15/21 14:20:48	pspd-288	994895	UNIT UPDATED - Unit: 4A18, Status: AM, Location: , Employees: 483
04/15/21 14:29:15	pspd-288	994895	EVENT REMARK - Delete Dispatch Warning
04/15/21 14:29:15	pspd-288	994895	UNIT UPDATED - Unit: 4C16, Status: DW, Location: 13617 BEACHWOOD AVE CLEV, Employees: 993423
04/15/21 14:29:20	pspd-288	994895	DISPOSITION ASSIGNED - ASST
04/15/21 14:29:20	pspd-288	994895	UNIT UPDATED - Unit: 4C16, Status: AM, Location: , Employees: 993423
04/15/21 14:29:21	pspd-288	994895	EVENT UPDATED - Total Assigned Units: 11,
04/15/21 14:29:21	pspd-288	994895	EVENT REMARK - ASST
04/15/21 14:36:46	pspd-288	994895	EVENT UPDATED - Total Assigned Units: 12,
04/15/21 14:36:46	pspd-288	994895	UNIT UPDATED - Unit: 4C26, Status: DP, Location: 13617 BEACHWOOD AVE CLEV, Employees: 716185
04/15/21 14:36:59	\$4C26	716185	UNIT UPDATED - Unit: 4C26, Status: ER, Location: 13617 BEACHWOOD AVE CLEV, Employees: 716185
04/15/21 14:37:31	pspd-288	994895	EVENT REMARK - 134/CAINE
04/15/21 14:37:31	pspd-288	994895	UNIT UPDATED - Unit: 4C26, Status: DW, Location: 13617 BEACHWOOD AVE CLEV, Employees: 716185
04/15/21 14:42:54	\$4G14	2512	EVENT UPDATED - Total Assigned Units: 11,
04/15/21 14:42:54	\$4G14	2512	EVENT REMARK - ASST C/W ASSIGNMENT / WCS3
04/15/21 14:42:54	\$4G14	2512	DISPOSITION ASSIGNED - ASST
04/15/21 14:42:54	\$4G14	2512	UNIT UPDATED - Unit: 4G14, Status: AM, Location: , Employees: 2512
04/15/21 15:08:24	\$4D17	202059	EVENT UPDATED - Total Assigned Units: 10,
04/15/21 15:08:24	\$4D17	202059	DISPOSITION ASSIGNED - ASST
04/15/21 15:08:24	\$4D17	202059	UNIT UPDATED - Unit: 4D17, Status: AM, Location: , Employees: 202059
04/15/21 15:08:25	\$4D17	202059	EVENT REMARK - Assist BCI with crime scene security, Crime scene log, BCI to handle, wcs 1
04/15/21 15:13:36	pspd-288	994895	EVENT UPDATED - Total Assigned Units: 9,
04/15/21 15:13:36	pspd-288	994895	DISPOSITION ASSIGNED - ASST
04/15/21 15:13:36	pspd-288	994895	UNIT UPDATED - Unit: 4D18, Status: AV, Location: , Employees:
04/15/21 15:15:40	pspd-288	994895	EVENT REMARK - ** LOI information for Event # 202100110000 was viewed at: 04/15/21 15:15:40 ** >>>> by: JINGER MALAVE on terminal: pspd-288
04/15/21 15:15:46	pspd-288	994895	EVENT REMARK - ** LOI information for Event # 202100110000 was viewed at: 04/15/21 15:15:46 ** >>>> by: JINGER MALAVE on terminal: pspd-288
04/15/21 16:10:59	pspd-288	994895	EVENT REMARK - PER S23 #9257 OK TO CLOSE DOWN TAC
04/15/21 16:46:56	\$4C26	716185	EVENT UPDATED - Total Assigned Units: 8,
04/15/21 16:46:56	\$4C26	716185	EVENT REMARK - asst on crime scene
04/15/21	\$4C26	716185	DISPOSITION ASSIGNED - ASST

16:46:56			
04/15/21 16:46:56	\$4C26	716185	UNIT UPDATED - Unit: 4C26, Status: AM, Location: , Employees: 716185
04/15/21 16:53:23	pspd-288	994895	EVENT UPDATED - Total Assigned Units: 7,
04/15/21 16:53:23	pspd-288	994895	DISPOSITION ASSIGNED - ASST
04/15/21 16:53:23	pspd-288	994895	UNIT UPDATED - Unit: 4S14, Status: AV, Location: , Employees:
04/15/21 16:53:30	pspd-288	994895	EVENT UPDATED - Total Assigned Units: 6,
04/15/21 16:53:30	pspd-288	994895	DISPOSITION ASSIGNED - ASST
04/15/21 16:53:30	pspd-288	994895	UNIT UPDATED - Unit: 4I77, Status: AV, Location: , Employees:
04/15/21 16:53:37	pspd-288	994895	EVENT UPDATED - Total Assigned Units: 5,
04/15/21 16:53:37	pspd-288	994895	DISPOSITION ASSIGNED - ASST
04/15/21 16:53:37	pspd-288	994895	UNIT UPDATED - Unit: 4S63, Status: AV, Location: , Employees:
04/15/21 16:53:54	pspd-288	994895	EVENT UPDATED - Total Assigned Units: 4,
04/15/21 16:53:54	pspd-288	994895	DISPOSITION ASSIGNED - DNCB
04/15/21 16:53:54	pspd-288	994895	UNIT UPDATED - Unit: 4F17, Status: AM, Location: , Employees: 505, 994366
04/15/21 16:53:59	pspd-288	994895	EVENT UPDATED - Total Assigned Units: 3,
04/15/21 16:53:59	pspd-288	994895	DISPOSITION ASSIGNED - ASST
04/15/21 16:53:59	pspd-288	994895	UNIT UPDATED - Unit: 4S70, Status: AV, Location: , Employees:
04/15/21 16:54:06	pspd-288	994895	EVENT UPDATED - Total Assigned Units: 2,
04/15/21 16:54:06	pspd-288	994895	DISPOSITION ASSIGNED - ASST
04/15/21 16:54:06	pspd-288	994895	UNIT UPDATED - Unit: 8836, Status: AV, Location: , Employees:
04/15/21 16:54:14	pspd-288	994895	EVENT UPDATED - Total Assigned Units: 1,
04/15/21 16:54:14	pspd-288	994895	DISPOSITION ASSIGNED - ASST
04/15/21 16:54:14	pspd-288	994895	UNIT UPDATED - Unit: 8840, Status: AV, Location: , Employees:
04/15/21 16:57:04	pspd-288	994895	EVENT UPDATED - Total Assigned Units: 0,
04/15/21 16:57:04	pspd-288	994895	EVENT CLOSED -
04/15/21 16:57:04	pspd-288	994895	EVENT UPDATED - Closing Employee Id: 994895, Closing Terminal: pspd-288, Closing Time: 04/15/21 16:57:04, Is Open: False,
04/15/21 16:57:04	pspd-288	994895	EVENT REMARK - ASST
04/15/21 16:57:04	pspd-288	994895	DISPOSITION ASSIGNED - ASST
04/15/21 16:57:04	pspd-288	994895	UNIT UPDATED - Unit: 4A16, Status: AM, Location: , Employees: 199138, 706181

Cuyahoga County Sheriff's Office

Custody Receipt

On **04/28/2021** at **9:19 am** the following items were transferred so that the current custody reads as follows;
"Returned To Owner". This custody update was processed by **Devlin, Pdraig**.

Case #: 21015453

Item #	Description	Item Notes:
036	Black left boot	
037	Black right boot	
038	Duty belt with holster and keepers	
039	One Motorola radio with mic Serial #: 1852462 / H98UCF9PW6AN	
040	One Axon taser yellow in color Serial #: X13007Y9X	
041	Two Axon Taser cartridges black and green in color	
042	Smith and Wesson chain handcuffs Serial #: X47910	
043	VIPERTEK black hinged handcuffs	
044	One Streamlight flashlight Serial #: 151645Q1119	
051	One metal handcuff key	
054	One Crossfire 10% OC spray in 3oz can	
055	One skull cap black in color with CPD patch	
056	One dark gray Kershaw knife	

Cuyahoga County Sheriff's Office

Custody Receipt



**Anthony
Lampkin
Patrol Officer**

**City of Cleveland
Department of Public Safety**

Division of Police

2462



Total # of Items Transferred: 13

Comments: ITEMS RTO CPD OFFICER ANTHONY LAMPKIN #2462

Devlin, Padraig

Released By

A handwritten signature in black ink, appearing to read "Anthony Lampkin #2462".

Released To (ANTHONY LAMPKIN #2462)

04/28/2021 - 9:19 am

Date/Time

Cuyahoga County Sheriff's Office

Custody Receipt

On **04/28/2021** at **9:24 am** the following item was transferred so that the current custody reads as follows;
"Returned To Owner". This custody update was processed by **Devlin, Padraig**.

Case #: **21015453**

Item #	Description
068	black belt removed from item 034
	Item Notes:



**Anthony
Lampkin**
Patrol Officer

City of Cleveland
Department of Public Safety
Division of Police
2462



Total # of Items Transferred: 1

Comments: ITEMS RTO CPD OFFICER ANTHONY LAMPKIN #2462

Devlin, Padraig

Released By

Released To (ANTHONY LAMPKIN #
2462)

04/28/2021 - 9:24 am

Date/Time

Cuyahoga County Sheriff's Office

Custody Receipt

On 04/28/2021 at 9:31 am the following item was transferred so that the current custody reads as follows; "Returned To Owner". This custody update was processed by Devlin, Padraig.

Case #: 21015453

Item #	Description
033	Outer carrier vest with badge #2462
	Item Notes:

Total # of Items Transferred: 1

Comments: ITEM RTO ANTHONY LAMPKIN #2462

Devlin, Padraig

Released By



Released To (ANTHONY LAMPKIN #2462)

04/28/2021 - 9:31 am

Date/Time

CUYAHOGA COUNTY SHERIFF'S DEPARTMENT

FILE NO. 21015453DATE April 15, 2021

FROM Detective Joseph Goudy TO Detective Sergeant Bartzcak
SUBJECT Synopsis of CCSD Case #21015453
Cleveland Police Use of Deadly Force
COPIES File

PREFACE

The following is a synopsis of the Cuyahoga County Sheriff's Department (CCSD) investigation into the City of Cleveland Division of Police (CPD) Use of Deadly Force (UDF) incident which resulted in the death of Innes Kirk Lee Jr (Lee). The incident occurred at 4281 East 134th Street in the City of Cleveland, Ohio, on April 15, 2021, at approximately 8:15 AM.

This report will only summarize the information that the investigative team determined to provide an overarching understanding of what information was obtained by CCSD regarding this incident. As this is a summary of the investigative efforts, it is recommended that the information be cross-referenced with the relevant report, video or audio recording that is being provided herein. Further, audio and/or video recordings exist for the majority of the interviews conducted which reveal further details of the statements given regarding this incident.

Acronyms may be utilized throughout this investigative synopsis, however, each abbreviated term will be identified when initially referenced, and its acronym will follow in parenthesis. A table of contents and the summary of the investigative file are provided in this document to assist the reader. The time difference for the footage made available, if at all, will be included with the respective footage.

Finally, the CCSD conducted this investigation to determine, to the extent possible, the facts and circumstances surrounding this use of deadly force incident. As unbiased collectors of facts, the CCSD investigative team has not, and will not, render any opinion as to the legality of the officers' actions. Rather, these decisions are in the sole purview of the Ohio Attorney General's Office, the Grand Jurors of Cuyahoga County, and/or the United States Department of Justice.

CUYAHOGA COUNTY SHERIFF'S DEPARTMENT

TABLE OF CONTENTS

Preface	1
Table of Contents.....	2
Pre-Incident Summary.....	3
Incident Summary.....	3-6
Investigative Process.....	7
Officer Daniel Piper	7-8
Decedent Innes Lee.....	9
Medical Examiner	10
Cause of Death.....	10
Manner of Death	10
Background on Involved Parties	11-12
Cleveland Police Interviews.....	12-17
EMS Interviews.....	17-18
Civilian Interviews.....	19
Documents Outstanding	20
Final Notes	20
Investigative File Contents	21-35

CUYAHOGA COUNTY SHERIFF'S DEPARTMENT**PRE-INCIDENT SUMMARY**

On the morning of Thursday, April 15, 2021, Cleveland Division of Police Officer Daniel Piper (Piper) was working his assigned shift at the fourth district Cleveland Police Headquarters starting at 0600 hrs and ending at 1400 hrs. The weather was 46 degrees, and dropping to 41 degrees during the evening and into the night. The sky was cloudy with rain along with snow and sleet at random times.

Prior to the incident, Cleveland Police were notified of a civil disturbance involving a male, identified as Innes Lee and his cousin Isaac Foster, and their refusal to leave 13617 Beechwood Avenue at approximately 0400 hrs on the same date. Later on, it was discovered that Lee initially showed up to speak with his girlfriend Perfect. Upon Officers arrival, Foster was eventually arrested for being in possession of drugs and a firearm. At that time, Lee ran through the yards to evade capture and was not located.

At 0800 hrs, according to the interview conducted with Cleveland Police Sgt Stephanie May, Lee returned to 13617 Beechwood Avenue. The original caller notified the Cleveland Police Department again. At this point, Sgt May dispatched officer's to the area with the additional information pertaining to Lee having a homicide warrant. Officers who responded in the area were given the description of a black male wearing a hooded sweatshirt with the hood being up.

INCIDENT SUMMARY

At this time Officer Piper and his partner Officer Trinh arrived in the area to assist zone cars with locating Lee. After arriving in the area, additional radio traffic provided information stating Lee was seen near 4281 East 134th Street. Officer Piper stated he and Officer Trinh initially drove by the house and did not see any movement there. After the initial drive by of the house, Officer Piper and Officer Trinh circled around and arrived near the house. Officer Trinh, who was driving at the time, stated he parked one house away from the target house.

When Officer Piper and Officer Trinh exited CPD marked unit #408, Officers Lampkin and Cedano also arrived and exited their vehicle. They all heard what sounded like a door opening and closing from the rear of the house (4281 E. 134th Street). When Officers Piper and Trinh approached the driveway, they saw Lee running from the rear of the house and toward the back yard. Officer Piper stated he recognized Lee from the photo that was provided on his mobile data terminal (MDT) located in marked unit #408. Lee's information and photo was initially provided to the officers checking the area as it pertained to Lee running from officers earlier in the morning from 13617 Beechwood Avenue

CUYAHOGA COUNTY SHERIFF'S DEPARTMENT

and the active homicide warrant that was issued for him from a prior incident. At this point, Officer Piper called out Lee's location over his portable radio and began to pursue him on foot up the driveway of 4281.

Officer Trinh ran back to the marked unit to drive around the block to cut Lee off at the pass. As Officer Piper reached the backyard, he saw Lee attempting to climb the wooden fence located in the back of the property. Officer Piper ordered Lee to get down from the fence. As Lee got down off the fence, he placed his right hand in his pocket and attempted to pull something out. Officer Piper stated at this point, Lee was having trouble removing the object from his pocket. Officer Piper ordered Lee to stop reaching in his pockets, but Lee refused to comply.

It was at that moment when Officer Piper removed his duty weapon from his holster and held it in a high ready position. Officer Piper stated he closed the gap and tried to grab Lee, but Lee spun out of his grip. As Lee spun away from Officer Piper, Lee was able to remove the object, which turned out to be a handgun, from his right pocket. Officer Piper stated Lee removed the gun from his pocket and began to raise it in his direction, Officer Piper fired 4 rounds at Lee.

Lee immediately fell to the ground. His gun fell out of his right hand and landed on the ground nearby. Officer Piper stated he immediately notified dispatch via his portable radio of shots fired and that the male (Lee) was down and to have EMS respond. Officer Piper told other responding officers to get a first aid kit and to start administering First Aid and CPR. Officer Piper retrieved the gun used by Lee and secured it in his right cargo pant pocket for safe keeping. The gun was identified as a Smith and Wesson model M&P, 9mm with serial number HMP6782. Officer Piper stated he was in fear of his life when Lee pulled the handgun from his pocket.

Officer Trinh arrived in the back yard immediately following the shooting to assist with first aid on Lee. Officer Trinh stated just before the shooting occurred, he ran back to his car to drive around to the other street to cut Lee off from running through the yards. Officer Trinh further stated just before he was able to get into the car, he heard shots fired from behind the house. Officer Trinh stated he immediately ran to the back of the house. He was in fear of his partner's life and wanted to go help him.

Body camera video obtained confirmed what Officer Piper stated. The video shows Officer Piper and his partner Officer Trinh, arriving in the area of 4281 East 134th Street in the City of Cleveland. As Officer Piper approached the residence, it is at that moment when he heard a door close and then noticed Lee exiting from the rear of 4281 East 134th street. The body camera footage also shows Lee failing to comply with orders and pulling a handgun from his pocket.

CUYAHOGA COUNTY SHERIFF'S DEPARTMENT

Furthermore, the body camera video shows Lee raising the handgun up in the direction of Officer Piper as Officer Piper fired his weapon.

This information was also confirmed and further described by the witness, Kali Pace during the interview conducted on April 15th, 2021 at 1700 hrs. Pace stated the decedent, Lee, stayed at 4281 East 134 periodically. Pace referred to Lee as his street name "P-Nut" or "Nut". Pace stated her and her boyfriend Daron Armstrong have been staying upstairs of the residence. Furthermore, Pace stated Armstrong and Lee were friends. Pace stated she didn't have much interaction with Lee when he would be at the residence. Lee and Armstrong would usually interact with one another.

Pace stated on the evening of April 14th, 2021, Lee was at the residence and she believed that he was snorting cocaine by himself in the basement sometime after 10 pm. After doing so, Pace stated Lee became aggressive and was fighting with his girlfriend, "Perfect" over the telephone. Pace overheard Lee tell Perfect, "bitch, I will kill you!" After that, Pace recalled Lee coming and going from the residence throughout the night and using Armstrongs phone to call Perfect.

On April 15th, 2021, Pace recalled waking up between 6 am and 8 am to Lee throwing rocks at the window of the house (4281 East 134th Street). Lee was trying to get into the house and was yelling for Armstrong. When Lee entered the house, he grabbed Pace's cell phone and went to a separate room to call his girlfriend Perfect to ask her if his cousin was in jail. Pace stated Lee was not acting himself. Pace stated Lee was acting scared and paranoid and made the statement, "Im going to die about this shit."

Pace stated, approximately five minutes later Lee said the police were looking for him. Armstrong replied to Lee by telling him to run. At this point, Pace stated Lee ran out of the house. Pace stated she hid in a room upstairs of the residence squatting under a window while Armstrong ran and hid inside another room behind a chair. Pace witnessed Lee run out the back door of the residence and try to climb over the fence.

After Lee's unsuccessful attempt to get over the fence, Pace stated she saw Lee standing in the back yard and draw his gun from his right pocket. After he drew his gun from his right pocket, Pace stated Lee, then, pointed it at the Officer to shoot him. During this explanation, Pace physically demonstrated how Lee retrieved the gun and pointed it at the Officer. According to Pace, the Officer did not have his weapon out at that point. Pace ducked down and heard a shot fired, which she believes was Lee firing first followed by two additional shots being fired. After the shots were fired, Pace looked out the window again and saw Lee lying on the ground while the Officers were performing CPR on him. Lastly, Pace stated she has only known Lee for about a month and had seen him carry the same gun he had in his possession previously.

CUYAHOGA COUNTY SHERIFF'S DEPARTMENT

The Officers provided chest compressions along with triage equipment in attempt to stop the bleeding. After EMS arrived on scene EMT McLelland attached a three (3) lead monitor which did not detect electric heart activity. Lee also did not show any signs of life. EMT McLelland pronounced the patient, Lee, deceased on scene after life saving measures were taken.

(Please refer to the Cleveland Police Department Homicide Report, Witness Statements, and Medical Examiner Reports for further information)

INVESTIGATIVE PROCESS:

The following is a timeline of events relevant to this incident commencing with the initial call out to the scene, and concluding with the completed investigation provided to the Ohio Attorney General's Office Prosecutor

DATE/TIME	ASSIGNMENT
4/15/2021 at 0815 hrs	-CCSD UDF Team was notified and responded to scene - (4281 E. 134 th Street, Cleveland, Ohio). Scene processed by BCI crime scene unit- information collected. -Evidence turned over to CCSO evidence unit – placed into evidence. -Medical Examiner arrived on scene and took control of decedents body -Received body camera footage from CPD Officers on scene
4/16/2021	-Notified Attorney General Prosecutor Anthony Pierson -Autopsy performed by ME's office on decedent.
4/20/2021	-Completed EMS interviews
4/22/2021	-Request sent to CPD Personnel for Officer File
4/28/2021	-CPD Body Cam footage sent to APA Anthony Miranda for Garrity review.
5/11/2021	-CPPA President Jeff Fulmer returned call for CPD Interviews -Officer Piper scheduled for 05/14/2021 -Additional CPD Officer's scheduled for 05/14/2021
5/13/2021	-CPD Officer Piper Personnel file and reports emailed directly to APA Anthony Miranda from CPD Capt. Pillow for Garrity review
05/14/2021	Interview CPD Officer Daniel Piper, followed by Officer's Cedano, Lampkin, Trinh and Brown

CUYAHOGA COUNTY SHERIFF'S DEPARTMENT

5/18/2021	-Received "Cleaned" CPD reports from Anthony Miranda
Not yet received as of 5-28-21	Received DNA results from ME's Office
	Completed UDF investigative file submitted to Ohio Attorney General's Office Prosecutor Anthony Pierson for review.

PARTIES INVOLVED:**OFFICER:**

Name: Daniel W. Piper Jr
 DOB: August 26, 1980
 AGE: 40
 SEX: Male
 HEIGHT: 6'0"
 WEIGHT: 210
 SSN: [REDACTED]

HIRED DATE: January 10, 2011
 GRADUATED ACADEMY: June 24, 2011
 LAYED OFF: June 24, 2011
 RECALLED: April 5, 2012
 APPOINTMENT DATE: April 30, 2012
 ASSIGNMENT: Fourth District
 BADGE No. 1113
 RANK: Patrolman
 WEAPON: Issued
 MAKE: Glock
 MODEL: 17
 CALIBER: 9mm
 SERIAL# MPD932
 ROUND CAPACITY 17+1

The weapon used by Officer Piper was rendered safe by Detective Steven Veverka of the Cuyahoga County Sheriff's Department. The weapon was confiscated relative to this incident and turned over to the Cuyahoga County Sheriff's Department evidence unit for further processing.

CUYAHOGA COUNTY SHERIFF'S DEPARTMENT**OFFICER ATTIRE:**

On the date of this incident, Officer Piper was wearing the designated Cleveland Division of Police uniform of the day. Officer Piper was dressed in a long sleeve navy blue uniform shirt. The uniform had affixed to his outer vest carrier a silver plated metal badge same being clearly visible. Also, affixed and clearly visible on each sleeve of the uniform shirt were embroidered, Cleveland Police Department shoulder patch. Additionally, Officer Piper was wearing his issued duty gear on his duty belt to include his right handed holster and issued glock hand gun along with his issued less lethal weapons.

(Refer to CCSD photos DSC_0433.JPG to DSC_0501)

DECEDENT:



Name: Innes Kirk Lee Jr
 DOB: September 12, 1995
 Age: 25
 Sex: Male
 Height: 5'6
 Weight: 170
 SSN: [REDACTED]
 Address: 3677 East 147th Street,
 Cleveland, Ohio (OHLEG)

*Innes Lee was pronounced deceased by Cleveland Emergency Medical Service after life-saving measures were taken for the gunshot wounds. Due to the seriousness of the gunshot wounds, Lee succumbed to his injuries on scene.
 (Please see attached medical examiner reports)*

DECEDENT ATTIRE:

On the date of this incident, Innes Lee was wearing a grey long sleeve sweat jacket, white t-shirt with blue pants and black colored shoes. ***(Refer to photos DPB_4203.JPG to DPB_4221 of the Ohio Bureau of Criminal Investigations Crime Scene Unit)***

NEXT OF KIN:

NAME: Innes Lee Sr. (Father)
 DOB: June 7th, 1971
 AGE: 49
 Sex: Male
 SSN: [REDACTED]
 ADDRESS: 1660 East 93rd Street, Cleveland, Ohio 44106

CUYAHOGA COUNTY SHERIFF'S DEPARTMENT

CUYAHOGA COUNTY MEDICAL EXAMINERS OFFICE

According to the autopsy report provided by the medical examiner's office, the decedent (Lee) was transported from 4281 East 134th Street to the Cuyahoga County Medical Examiner's Office by Esposito Mortuary Services. The decedent was assigned Cuyahoga County Medical Examiner case number **IN2021-0707**.

On April 16, 2021 Dr. Joseph Felo M.D., Cuyahoga County Medical Examiner, Conducted a post-mortem examination and provided the following information:

CAUSE OF DEATH

Multiple gunshot wounds of the head, thorax, left arm, right upper arm with visceral, vascular and skeletal injuries

MANNER OF DEATH

Homicide (completed 4-23-21)

(Please refer to the Cuyahoga County Medical Examiner's Report for further detail.)

BACKGROUND ON PARTIES INVOLVED

Innes Lee Jr (DECEDENT)

- 25-year-old male
- Driver's license status: Suspended
- Permanent ID Card status: Expired
- Warrant Info
 - Homicide – Cleveland Police Department
 - Weapons Offense – Cuyahoga County Sheriffs Department
- Suspension Info
 - Non Compliance Suspension - #2016TRD013347 – Cleveland Muni
 - Court Suspension/Major Offense – Cuy Co. Juvenile #TR1241690
 - Court Suspension/Major Offense – Cuy Co. Juvenile #TR12417029
 - Non Compliance Suspension – Cuy Co. Juvenile #12409569
 - Court Suspension/Minor Offense – Cuy Co. Juvenile #TR12412821
 - Court Suspension/Minor Offense (x2) – Cuy Co. Juvenile #12409569
 - Non Compliance Suspension – Cuy. Co Juvenile #TR12417029
- Convictions
 - Miscellaneous / 08-08-2018 / Garfield Hts Municipal Court
 - No Drivers License / 08-08-2018 / Garfield Hts Municipal Court
 - Driving Under Suspension / 08-08-2018 / Garfield Hts Municipal Court
 - Driving Under Suspension / 05-27-2017 / Bedford Municipal Court
 - Driving Under Suspension / 04-12-2016 / Cleveland Municipal Court
 - Miscellaneous / 07-20-2014 / Shaker Hts Municipal Court
 - Driving Under Suspension / 09-30-2012 / Cuy Co Juvenile Court
 - Driving Under Suspension / 10-02-2012 / Cuy Co Juvenile Court

CUYAHOGA COUNTY SHERIFF'S DEPARTMENT

- Juvenile Miscellaneous / 07-24-2012 / Cuy Co Juvenile Court
- Seat Belt Violation / 05-25-2012 / Cuy Co Juvenile Court
- Speed / 09-20-2011 / Cuy Co Juvenile Court
- Juvenile Miscellaneous / 05-25-2012 / Cuy Co Juvenile Court
- Computerized Criminal History (CCH)
 - FBI # [REDACTED]
 - BCI # [REDACTED]
 - OHIO**
 - Aggravated Menacing Felony / May 28, 2014 / Cleveland Police Dept
 - Carrying Concealed Weapons / July 20, 2014 / Shaker Hts Police Dept
 - Domestic Violence – Felony, Improperly Handling Firearms in MV,
 - Endangering Children-Felony, Aggravated Menacing-Felony
 - / January 22, 2015 / Cleveland Police
 - Trafficking in Drugs-Felony, Possession of Criminal Tools-Felony
 - / February 2, 2016 / Cleveland Police
 - Trafficking in Drugs-Felony, Possessing Criminal Tools-Felony
 - / February 5, 2016 / Cleveland Police
 - Trafficking in Drugs-Felony, Possessing Criminal Tools-Felony
 - / May 4, 2016 / Cuyahoga County Sheriff
 - Assault Misdemeanor / June 22, 2016 / Cleveland Police Dept
 - Felonious Assault, Probation Violation / June 25, 2016
 - Cleveland Police
 - Probation Violation / March 7, 2017 / Orange Village Police Dept
 - Possession of Drugs-Felony / May 10, 2017 / Cleveland Police Dept
 - Probation Violation / August 4, 2017 / Cuyahoga County Sheriff
 - Probation Violation / August 28, 2018 / Cuyahoga County Sheriff
 - Probation Violation / December 11, 2018 / Cuyahoga County Sheriff
 - Trafficking in drugs-felony, possessing criminal tools
 - / February 25, 2019 / Cuyahoga County Sheriff
 - Sentenced to Lorain Correctional Institution - 1 year / Feb. 28, 2019
 - Aggravated Robbery-Felony / July 27, 2020 / Cleveland Police Dept.
 - ALABAMA**
 - Disorderly Conduct, Obstructing Justice, Making a false report, Resisting Arrest, Appears in public under the influence
 - July 5, 2020 / Talladega Co Sheriff's Department

Officer Daniel Piper

- EDUCATION
 - North Royalton High School
 - Cuyahoga Community College – West Campus
- YEARS EXPERIENCE
 - Appointment: April 30, 2012 to Present - 9 years
- ACADEMY HISTORY
 - Attended Cleveland Police Academy
 - January 10, 2011 to June 24, 2011
- TRAFFIC HISTORY / CRIMINAL HISTORY

CUYAHOGA COUNTY SHERIFF'S DEPARTMENT

- Suspensions
 - OVI Suspension / 08-17-2005 / Bedford Municipal Court
- Convictions
 - Assured Clear Distance / 12-18-2010 / Norwalk Municipal Court
 - Speed / 10-12-2009 / Huron Municipal Court
 - Traffic Control Lights / 08-29-2007 / Cleveland Municipal Court
 - OVI / 08-17-2005 / Bedford Municipal Court
 - Assured Clear Distance / 03/20/2004 / Berea Municipal Court
 - Speed / 08-21-2001 / Cleveland Municipal Court
 - Speed / 01-15-2000 / Athens Municipal Court
 - Speed / 07-15-1999 / Medina Municipal Court
- Accidents
 - Line of Duty / 11-11-2019 / Cleveland Police Department
 - Line of Duty / 10/17/2015 / Cleveland Police Department
 - Property Damage / 12-16-2010 / OSP – Norwalk
 - Non-Incapacitating / 06-12-2005 / Glenwillow Police Department
 - Property Damage / 03-20-2004 / OSP - Medina
- Computerized Criminal History (CCH)
 - Nothing reported for Officer Piper

INTERVIEWS:

Cleveland Police Interview's

Officer Daniel Piper

- On May 14, 2021, Detective's Goudy and Gibson interviewed Officer Daniel Piper accompanied by CPPA Director Jeff Follmer
- Officer Piper was and is currently assigned to the Community Policing Unit
- Officer Piper's partner at the time of the incident was Officer Gino Trinh
- Normal shift is 9a-5p with rotating days off – Friday and Saturday or Sunday and Monday.
- On the day of the incident, shift was 6a-2p. Initially came in early for an operation with vice that ended up being cancelled. Told to stay on that shift for the day.
- The weather on the day of the incident was overcast and cloudy
- Officer Piper was wearing standard CPD uniform and carried the issued Glock duty weapon with 3 fully loaded magazines of 9mm ammo.

CUYAHOGA COUNTY SHERIFF'S DEPARTMENT

- Started the shift in the area of E. 65th and Fleet working a complaint of illegal narcotics and possible prostitution.
- Heard information over the radio about a male that previously fled from the previous shift, returning to the area of Beechwood and East 134th Street.
- The male (Lee) was wanted on a homicide and felonious assault warrant.
- Officer Piper and his partner decided to respond to the area to assist the zone cars with locating the male (Lee) due to the inactivity on their previous assignment.
- After arriving in the area, a description of the male and house, where he is suspected to be at, was given over the radio.
- After briefing with the zone cars, Officer Piper and Trinh drove by the house once but did not see the male (Lee).
- When they drove back around, they parked their car near the address and exited.
- After they exited the vehicle, they began to make their way toward the driveway.
- As they were approaching the driveway, they heard what sounded like a door closing from behind the house.
- When Officer Piper and Trinh reached the driveway, they saw the male run towards the backyard.
- Officer Piper stated the male matched the description given to him plus the photo provided via his MDT
- Officer Piper alerted dispatch and began to chase after him.
- When Officer Piper reached the backyard, he saw the male attempting to climb up and over a wooden fence.
- The Male (Lee) was not able to get over the fence.
- When the male got off the fence, he began to reach into his right pocket.
- Officer Piper told the male (Lee) to stop reaching.
- The male (Lee) was having trouble removing the item from his pocket.
- Officer Piper then removed his duty weapon from his holster
- Officer Piper attempted to get closer to grab the male (Lee)
- As he Officer Piper tried grabbing the male (Lee) he spun around
- After the male (Lee) spun around, he pulled a gun out of his pocket
- The male (Lee) was approximately 3-6 feet away from Officer Piper.

CUYAHOGA COUNTY SHERIFF'S DEPARTMENT

- When Officer Piper saw the male with the gun in hand, he fired 4 rounds at the male (Lee)
- The male (Lee) went down to the ground
- Officer Piper notified dispatch of the shots being fired and the male (Lee) was down.
- EMS was requested. First aid and CPR was immediately administered by additional officers on scene.
- Officer Piper secured the male's (Lee) gun inside his right cargo pant pocket
- Officer Piper does not believe the male (Lee) fired any rounds at him
- Officer Piper stated he was in fear of his life when the male began to point the gun at him.

Officer Anthony Lampkin

- On May 14, 2021 Detective's Goudy and Gibson interviewed CPD Officer Anthony Lampkin accompanied by CPPA Director Jeff Follmer
- On the day of the incident, Officer Lampkin was working 7a-3p with rotating days off.
- Officer Lampkin's partner on the day of the incident was Officer Cedeno
- Officer Lampkin stated they were briefed about a male with a homicide warrant that fled from the previous shift.
- During their shift, Officers received a call about the male (Lee) believed to be in the area of Beachwood and East 136th Street again.
- Officers Lampkin and Cedeno, along with other Officers, arrived in the area and briefed on the situation
- After briefing, Officer Lampkin and Cedeno toured the area, but did not locate the male (Lee)
- Received further information stating the male (Lee) may be located at 4281 East 134th Street.
- When Officer Lampkin and Cedeno arrived on the street, Officers Piper and Trinh also arrived
- Officer Lampkin heard what sounded like a screen door shutting.
- Officer Trinh alerted Officer Lampkin to the male running.

CUYAHOGA COUNTY SHERIFF'S DEPARTMENT

- Officer Lampkin stated Officer Trinh ran back to his vehicle while Officer Piper ran up the driveway
- Officer Lampkin ran up the driveway of the neighbors residence when he saw the male (Lee) try to climb up and over.
- When Officer Lampkin saw the male (Lee) not make it over the fence, Officer Lampkin ran back around the other side of the house and up the driveway where Officer Piper was.
- As Officer Lampkin ran up the driveway, he heard Officer Piper yell "gun" followed by several shots
- Officer Lampkin observed the male (Lee) get struck and fall to the ground.
- As the male fell to the ground, the gun that the male (Lee) possessed, flung out of his right hand and landed on the ground.
- Officer Lampkin stated, at that point, Officer Piper notified dispatch, "male shot" send EMS
- Immediately following, Officer Lampkin along with the other responding CPD units assisted with first aid on the male (Lee)

Officer Juan Cedano

- On May 14, 2021 at 1211 hrs, Detectives Goudy and Gibson interviewed CPD Officer Juan Cedano.
- Ofc. Cedano was working the day of the incident 7a-3p with partner Anthony Lampkin.
- Ofc. Cedano stated he received a radio call of a guy they are looking for walking down the street, around E.134st
- Ofc. Cedano meet up with other Officers before looking for the suspect with a murder warrant.
- Sgt. May came over the radio and gave an exact address of where the suspect is at.
- Ofc. Cedano and Lampkins went to the southside of the house when they arrived on scene.
- Ofc. Piper went up the driveway of the reported address.
- Ofc. Cedano believes Ofc. Piper was first to see the suspect because he heard him say "he's running east".
- Ofc. Cedano started to run around the house to the backyard and heard gun shots.
- Ofc. Cedano told us Ofc. Lampkin's was in front of me and when I saw the guy on the ground and ran to get my medical kit.
- Ofc. Cedano stated "we all worked on him taking turns and switching".

CUYAHOGA COUNTY SHERIFF'S DEPARTMENT

- Ofc. Cedano stated when EMS arrived on scene they pronounced him died on scene.
- Ofc. Cedano stated he was notified through radio transmission to respond to the area of the incident.

Officer Fred Brown

- On May 14th, 2021 at 1211 hrs Detectives Goudy and Gibson interviewd CPD Officer Fred Brown.
- Ofc. Brown was working the day of the oncident 7a-3p with partner Castiglione. Crusier #414
- Ofc. Brown and Castiglione started their shift by going to an alarm call on Edna rd to assit.
- Ofc. Brown and Castiglione turned body cameras on when they arrived on scene at the alarm.
- Ofc. Brown heard over the radio that the male night shift was looking for in the area of E.138 and Beachwood was in the area.
- Ofc. Brown stated the toured the area looking on 7 different streets from E.130th to E.136th.
- Ofc. Brown stated they saw the other cars pull up and get out, we were on Caine rd.
- Officers on scene called out that they were going to check the address in question.
- Sgt. May was relaying information to us third party.
- Ofc. Brown and Castiglione went one street east of the address given, E.134th he stated.
- As Ofc. Brown and Castiglione exited there vehicle they heard over the radio that he was running east. We ran to the fence to catch him.
- Then Ofc. Brown heard shots fired and Ofc. Castiglione yelled get to cover.
- Ofc. Brown heard over the radio Ofc. Piper say "shots fired roll EMS".
- Ofc. Brown told Castiglione to grab the medical kit because he had the keys to the cruiser.
- We ran ove and jumped the fence and saw a male on the ground.
- We started CPR/First aid
- Ofc. Brown stated he was originally told about Lee through Roll call.

CUYAHOGA COUNTY SHERIFF'S DEPARTMENT**Officer Gino Trinh**

- On May 14, 2021 at 1140 hrs, Detectives Goudy and Gibson interviewed CPD Officer Gino Trinh with approximately 2 years experience
- Ofc Trinh was working on the day of the incident 9a-5p with partner Officer Daniel Piper assigned to marked unit 408 working in the community policing unit.
- Heard call over the radio to patrol units about a male returning to a residence on Beechwood Avenue where he previously ran from third shift units.
- The night shift sergeant said over CPD radio channel #4 the male had a warrant and was possibly armed.
- Ofc Trinh asked his partner, Ofc Piper, if he wanted to respond to the area to assist. Ofc Piper said yes to responding.
- Upon arriving in the area, Ofc Trinh stated they met up with zone cars to formulate a plan
- Afterwards, Ofc Trinh and Piper began driving around the block in the area of E. 134th and Beechwood Ave.
- They received additional information over the radio that the male could be at a particular address on a E. 134th street. The information also had a description of the residence.
- Ofc Trinh stated they pulled up on E. 134th Street parking one house away.
- In addition, Ofc Trinh stated Officers. Cedano and Lampkin parked just behind their car.
- As Ofc Trinh and Piper began to approach the driveway of the house, Ofc Trinh heard what sounded like a security door open, then close.
- When Ofc Trinh looked down the driveway, he saw the male running towards the back yard from the rear door.
- Ofc Piper confirmed to Ofc Trinh that it was in fact the male they had been looking for.
- When Ofc Piper began to run down the driveway, Ofc Trinh returned to his marked unit to drive it around to the other street to cut the male off.
- Just before Ofc Trinh was about to enter the marked unit, he heard the shots fired, followed by Ofc Piper, on the radio, saying, "shots fired, shots fired."
- After Ofc Trinh heard the shots being fired, he turned around and ran down the driveway.
- As Ofc Trinh ran down the driveway, he noticed Ofc Piper either standing over the male or retrieving the handgun from the male.
- When Ofc Trinh made it to Ofc Piper, Ofc Piper told him to retrieve the first aid kit.

CUYAHOGA COUNTY SHERIFF'S DEPARTMENT

- Ofc Trinh began rendering first aid to the male.
- Ofc Trinh stated he saw the males gun on the ground
- At this point, Ofc Trinh saw Ofc Piper retrieve the male's gun and secure it in his cargo pant pocket.
- Ofc Trinh stated even though he wasn't in fear of his own life, he was in fear of his partner, Piper's life and regretted that he didn't go down the driveway immediately with Ofc Piper when they initially spotted the male.

Sergeant Stephanie May

- On May 06, 2021 at 1130 hours Detectives Divis and Gibson interviewed Stephanie May, a Cleveland Police Sergeant with approximately twenty (20) years of service.
- Sgt. May worked 04/14/2021 from 2200 hours through 04/15/2021 at 0800.
- Sgt. May recalls a zone car being dispatched to 13617 Beachwood Avenue for a civil dispute.
- CPD officers Luongo and Moyano responded and encountered an unknown male later identified as Innes Lee and Isaac Foster who was arrested on scene for drug possession and possession of a fire arm. Lee fled from CPD officers as Foster was being placed under arrest.
- Sgt. May was advised that the homeowner wished to speak with her so Sgt. May called the homeowner identified as "Monique" on her cell phone. Monique explained that her daughter ended a relationship with her boyfriend Innes Lee and it was Lee that was at the 13617 Beachwood address.
- Monique explained to Sgt. May that Innes Lee was a suspect in a homicide case and Sgt. May recalled dealing with Innes Lee two (2) days prior as a different female came into the fourth district police station to file a complaint against Lee. Sgt. May passed this information along to the command staff up to her commander.
- Sgt. May received a call from Monique at 0800 hours stating that Lee was back at her house. Monique was crying and in fear as Lee told Monique that he had nothing to lose.
- Sgt. May broadcasted this information over her radio and informed CPD command staff of the updated information including the warrant for Lee in connection with a homicide.
- The following shift (1st) was now on duty and being "fresh bodies" as described by Sgt. May, had responded to a separate address provided by Monique to set up a perimeter to search for Lee.

CUYAHOGA COUNTY SHERIFF'S DEPARTMENT**EMS Interviews****Medic Jared Venczel**

- On April 20, 2021 at 0930 hrs, Detectives Harvey and Divis interviewed medic Jared Venczel.
- Jared Venczel has worked for Cleveland EMS for approximately five (5) years, his regular partner is Catrina Mclelland
- Venczel and Mclelland worked 04/15/21 from 0700-1900 and were stationed at Medic 11
- Received a call sometime in the morning for a male with several penetrating wounds
- Responded to scene and were met by several uniformed police officers who escorted Venczel and Mclelland to the patient.
- Patient was described as being approximately twenty-five (25) years old, wearing blue jeans and a sweatshirt, lying in the supine position with three (3) penetrating wounds.
- Penetrating wounds included one (1) to the left cheek, one (1) to the left side of the chest and one (1) to the back of the right leg. Injuries were determined to be incompatible with life.
- Venczel noted extreme blood loss, severe facial trauma and what he believed to be damage to the brain.
- Venczel did not provide medical services due to there being no signs of life and the patient being declared deceased on scene.

Medic Catrina Mclelland

- On 05/11/21 at 1419 hours Detective Divis conducted a telephone interview of medic Catrina Mclelland.
- Mclelland has worked for Cleveland EMS for approximately five (5) years and her regular partner is Jared Venczel.
- Mclelland worked 04/15/21 from 0700-1900 and was stationed at Medic 11.
- Mclelland received computer notes from dispatch to respond to an address off of East 134th St. for a male suffering from gunshot wounds.
- Mclelland and Venczel arrived on scene and were escorted by police to the backyard of a residential home.

CUYAHOGA COUNTY SHERIFF'S DEPARTMENT

- Upon arrival to the patient CPR was in progress and triage equipment had been applied by law enforcement to attempt to stop the bleeding.
- Mclelland described the patient as an African American male in his early twenties with a penetrating wound to the head, chest and leg.
- Mclelland attached a three (3) lead monitor which did not detect electric heart activity. Mclelland pronounced the patient deceased on scene.
- Mclelland was with the patient for approximately fifteen (15) minutes and did not provide any further medical services after the patient was pronounced deceased.
- Mclelland notified her dispatch center and Cleveland EMS Captain Kavouros that the patient has been pronounced deceased.

Civilian Interviews

Kali Pace

- Interview conducted on April 15, 2021 by Detective's Goudy and Divis.
- Kali Pace was temporarily residing at 4281 E. 134th St. with her boyfriend Daron Armstrong for the month of April 2021.
- On April 14, 2021 a male by the street name P-Nut (Innes Lee) came to this address at 2200 hours. P-Nut went into the basement and ingested cocaine alone then left and returned to the house several times throughout the night as he was fighting with his girlfriend on Pace's cellphone, at one point threatening to kill her.
- Pace was woken up on 04/15/21 between 0600 and 0800 to P-Nut trying to get into her residence at 4281 E. 134th St. P-Nut entered the home, went to the second floor of the home and used Pace's cellphone to call his girlfriend. P-Nut was acting paranoid and stated "I'm going to die about this shit".
- P-Nut stated the police were outside looking for him and Armstrong told P-Nut to run.
- P-Nut ran out of the back/side door of the home and Pace and Armstrong his in separate rooms upstairs. Pace watched out of the rear window as she saw P-Nut attempt to jump over a fence then draw a gun and point it at the police.

CUYAHOGA COUNTY SHERIFF'S DEPARTMENT

- Pace stopped watching out of the window because she was scared, she heard what she described as “pow” which Pace believed to be P-Nut shooting at the police. Pace heard two (2) gunshots after that and when she looked outside she was P-Nut lying on the ground with three (3) ncops trying to help him by pumping his chest.
- Pace remained hidden in 4281 E. 134th St. until police called that they were searching the house and found her later that day.

**The Ohio Attorney General's Office will determine whether any of the above-listed individuals shall be required to testify before a Cuyahoga County Grand Jury.*

Outstanding Documents/Interviews

As of 5-28-21: the completed official evidence and Autopsy reports from the CCMEIO has not been completed or received. The unofficial autopsy results were received via telephone for the purpose of completing this synopsis.

FINAL NOTES

This investigation was conducted with the purpose of determining, to the extent possible, the facts and circumstances surrounding this use of force incident. As unbiased collectors of fact, the Cuyahoga County Sheriff's Investigative Team has not, and will not, render an opinion of the legality of the officers' actions. Instead, it is anticipated that this investigation will provide the basis of information for decisions to be rendered by the Ohio Attorney General's Office and/or the Department of Justice.

CUYAHOGA COUNTY SHERIFF'S DEPARTMENT

INVESTIGATIVE FILES CONTENTS**Investigator Documents****CCSD Photos**

- "S:\UDF Team\Lee, Innes\Photos"
 - "S:\UDF Team\Lee, Innes\Photos\CCSD Photos\21015453 Photos"
 - "S:\UDF Team\Lee, Innes\Photos\CCSD Photos\21015453 Photos\DSC_0434.JPG"
 - "S:\UDF Team\Lee, Innes\Photos\CCSD Photos\21015453 Photos\DSC_0435.JPG"
 - "S:\UDF Team\Lee, Innes\Photos\CCSD Photos\21015453 Photos\DSC_0431.JPG"
 - "S:\UDF Team\Lee, Innes\Photos\CCSD Photos\21015453 Photos\DSC_0432.JPG"
 - "S:\UDF Team\Lee, Innes\Photos\CCSD Photos\21015453 Photos\DSC_0433.JPG"
 - "S:\UDF Team\Lee, Innes\Photos\CCSD Photos\21015453 Photos\DSC_0440.JPG"
 - "S:\UDF Team\Lee, Innes\Photos\CCSD Photos\21015453 Photos\DSC_0436.JPG"
 - "S:\UDF Team\Lee, Innes\Photos\CCSD Photos\21015453 Photos\DSC_0437.JPG"
 - "S:\UDF Team\Lee, Innes\Photos\CCSD Photos\21015453 Photos\DSC_0438.JPG"
 - "S:\UDF Team\Lee, Innes\Photos\CCSD Photos\21015453 Photos\DSC_0439.JPG"
 - "S:\UDF Team\Lee, Innes\Photos\CCSD Photos\21015453 Photos\DSC_0443.JPG"
 - "S:\UDF Team\Lee, Innes\Photos\CCSD Photos\21015453 Photos\DSC_0444.JPG"
 - "S:\UDF Team\Lee, Innes\Photos\CCSD Photos\21015453 Photos\DSC_0445.JPG"
 - "S:\UDF Team\Lee, Innes\Photos\CCSD Photos\21015453 Photos\DSC_0441.JPG"
 - "S:\UDF Team\Lee, Innes\Photos\CCSD Photos\21015453 Photos\DSC_0442.JPG"
 - "S:\UDF Team\Lee, Innes\Photos\CCSD Photos\21015453 Photos\DSC_0448.JPG"
 - "S:\UDF Team\Lee, Innes\Photos\CCSD Photos\21015453 Photos\DSC_0449.JPG"
 - "S:\UDF Team\Lee, Innes\Photos\CCSD Photos\21015453 Photos\DSC_0450.JPG"

CUYAHOGA COUNTY SHERIFF'S DEPARTMENT

- "S:\UDF Team\Lee, Innes\Photos\CCSD Photos\21015453 Photos\DSC_0451.JPG"
- "S:\UDF Team\Lee, Innes\Photos\CCSD Photos\21015453 Photos\DSC_0452.JPG"
- "S:\UDF Team\Lee, Innes\Photos\CCSD Photos\21015453 Photos\DSC_0453.JPG"
- "S:\UDF Team\Lee, Innes\Photos\CCSD Photos\21015453 Photos\DSC_0454.JPG"
- "S:\UDF Team\Lee, Innes\Photos\CCSD Photos\21015453 Photos\DSC_0455.JPG"
- "S:\UDF Team\Lee, Innes\Photos\CCSD Photos\21015453 Photos\DSC_0446.JPG"
- "S:\UDF Team\Lee, Innes\Photos\CCSD Photos\21015453 Photos\DSC_0447.JPG"
- "S:\UDF Team\Lee, Innes\Photos\CCSD Photos\21015453 Photos\DSC_0463.JPG"
- "S:\UDF Team\Lee, Innes\Photos\CCSD Photos\21015453 Photos\DSC_0464.JPG"
- "S:\UDF Team\Lee, Innes\Photos\CCSD Photos\21015453 Photos\DSC_0465.JPG"
- "S:\UDF Team\Lee, Innes\Photos\CCSD Photos\21015453 Photos\DSC_0466.JPG"
- "S:\UDF Team\Lee, Innes\Photos\CCSD Photos\21015453 Photos\DSC_0467.JPG"
- "S:\UDF Team\Lee, Innes\Photos\CCSD Photos\21015453 Photos\DSC_0468.JPG"
- "S:\UDF Team\Lee, Innes\Photos\CCSD Photos\21015453 Photos\DSC_0469.JPG"
- "S:\UDF Team\Lee, Innes\Photos\CCSD Photos\21015453 Photos\DSC_0470.JPG"
- "S:\UDF Team\Lee, Innes\Photos\CCSD Photos\21015453 Photos\DSC_0456.JPG"
- "S:\UDF Team\Lee, Innes\Photos\CCSD Photos\21015453 Photos\DSC_0457.JPG"
- "S:\UDF Team\Lee, Innes\Photos\CCSD Photos\21015453 Photos\DSC_0458.JPG"
- "S:\UDF Team\Lee, Innes\Photos\CCSD Photos\21015453 Photos\DSC_0459.JPG"
- "S:\UDF Team\Lee, Innes\Photos\CCSD Photos\21015453 Photos\DSC_0460.JPG"
- "S:\UDF Team\Lee, Innes\Photos\CCSD Photos\21015453 Photos\DSC_0461.JPG"
- "S:\UDF Team\Lee, Innes\Photos\CCSD Photos\21015453 Photos\DSC_0462.JPG"
- "S:\UDF Team\Lee, Innes\Photos\CCSD Photos\21015453 Photos\DSC_0478.JPG"

CUYAHOGA COUNTY SHERIFF'S DEPARTMENT

- "S:\UDF Team\Lee, Innes\Photos\CCSD Photos\21015453 Photos\DSC_0479.JPG"
- "S:\UDF Team\Lee, Innes\Photos\CCSD Photos\21015453 Photos\DSC_0480.JPG"
- "S:\UDF Team\Lee, Innes\Photos\CCSD Photos\21015453 Photos\DSC_0481.JPG"
- "S:\UDF Team\Lee, Innes\Photos\CCSD Photos\21015453 Photos\DSC_0482.JPG"
- "S:\UDF Team\Lee, Innes\Photos\CCSD Photos\21015453 Photos\DSC_0483.JPG"
- "S:\UDF Team\Lee, Innes\Photos\CCSD Photos\21015453 Photos\DSC_0484.JPG"
- "S:\UDF Team\Lee, Innes\Photos\CCSD Photos\21015453 Photos\DSC_0485.JPG"
- "S:\UDF Team\Lee, Innes\Photos\CCSD Photos\21015453 Photos\DSC_0471.JPG"
- "S:\UDF Team\Lee, Innes\Photos\CCSD Photos\21015453 Photos\DSC_0472.JPG"
- "S:\UDF Team\Lee, Innes\Photos\CCSD Photos\21015453 Photos\DSC_0473.JPG"
- "S:\UDF Team\Lee, Innes\Photos\CCSD Photos\21015453 Photos\DSC_0474.JPG"
- "S:\UDF Team\Lee, Innes\Photos\CCSD Photos\21015453 Photos\DSC_0475.JPG"
- "S:\UDF Team\Lee, Innes\Photos\CCSD Photos\21015453 Photos\DSC_0476.JPG"
- "S:\UDF Team\Lee, Innes\Photos\CCSD Photos\21015453 Photos\DSC_0477.JPG"
- "S:\UDF Team\Lee, Innes\Photos\CCSD Photos\21015453 Photos\DSC_0493.JPG"
- "S:\UDF Team\Lee, Innes\Photos\CCSD Photos\21015453 Photos\DSC_0494.JPG"
- "S:\UDF Team\Lee, Innes\Photos\CCSD Photos\21015453 Photos\DSC_0495.JPG"
- "S:\UDF Team\Lee, Innes\Photos\CCSD Photos\21015453 Photos\DSC_0496.JPG"
- "S:\UDF Team\Lee, Innes\Photos\CCSD Photos\21015453 Photos\DSC_0497.JPG"
- "S:\UDF Team\Lee, Innes\Photos\CCSD Photos\21015453 Photos\DSC_0498.JPG"
- "S:\UDF Team\Lee, Innes\Photos\CCSD Photos\21015453 Photos\DSC_0499.JPG"
- "S:\UDF Team\Lee, Innes\Photos\CCSD Photos\21015453 Photos\DSC_0500.JPG"
- "S:\UDF Team\Lee, Innes\Photos\CCSD Photos\21015453 Photos\DSC_0486.JPG"

CUYAHOGA COUNTY SHERIFF'S DEPARTMENT

- "S:\UDF Team\Lee, Innes\Photos\CCSD Photos\21015453 Photos\DSC_0487.JPG"
- "S:\UDF Team\Lee, Innes\Photos\CCSD Photos\21015453 Photos\DSC_0488.JPG"
- "S:\UDF Team\Lee, Innes\Photos\CCSD Photos\21015453 Photos\DSC_0489.JPG"
- "S:\UDF Team\Lee, Innes\Photos\CCSD Photos\21015453 Photos\DSC_0490.JPG"
- "S:\UDF Team\Lee, Innes\Photos\CCSD Photos\21015453 Photos\DSC_0491.JPG"
- "S:\UDF Team\Lee, Innes\Photos\CCSD Photos\21015453 Photos\DSC_0492.JPG"
- "S:\UDF Team\Lee, Innes\Photos\CCSD Photos\21015453 Photos\DSC_0508.JPG"
- "S:\UDF Team\Lee, Innes\Photos\CCSD Photos\21015453 Photos\DSC_0509.JPG"
- "S:\UDF Team\Lee, Innes\Photos\CCSD Photos\21015453 Photos\DSC_0510.JPG"
- "S:\UDF Team\Lee, Innes\Photos\CCSD Photos\21015453 Photos\DSC_0511.JPG"
- "S:\UDF Team\Lee, Innes\Photos\CCSD Photos\21015453 Photos\DSC_0512.JPG"
- "S:\UDF Team\Lee, Innes\Photos\CCSD Photos\21015453 Photos\DSC_0513.JPG"
- "S:\UDF Team\Lee, Innes\Photos\CCSD Photos\21015453 Photos\DSC_0514.JPG"
- "S:\UDF Team\Lee, Innes\Photos\CCSD Photos\21015453 Photos\DSC_0515.JPG"
- "S:\UDF Team\Lee, Innes\Photos\CCSD Photos\21015453 Photos\DSC_0501.JPG"
- "S:\UDF Team\Lee, Innes\Photos\CCSD Photos\21015453 Photos\DSC_0502.JPG"
- "S:\UDF Team\Lee, Innes\Photos\CCSD Photos\21015453 Photos\DSC_0503.JPG"
- "S:\UDF Team\Lee, Innes\Photos\CCSD Photos\21015453 Photos\DSC_0504.JPG"
- "S:\UDF Team\Lee, Innes\Photos\CCSD Photos\21015453 Photos\DSC_0505.JPG"
- "S:\UDF Team\Lee, Innes\Photos\CCSD Photos\21015453 Photos\DSC_0506.JPG"
- "S:\UDF Team\Lee, Innes\Photos\CCSD Photos\21015453 Photos\DSC_0507.JPG"
- "S:\UDF Team\Lee, Innes\Photos\CCSD Photos\21015453 Photos\DSC_0522.JPG"
- "S:\UDF Team\Lee, Innes\Photos\CCSD Photos\21015453 Photos\DSC_0523.JPG"

CUYAHOGA COUNTY SHERIFF'S DEPARTMENT

- "S:\UDF Team\Lee, Innes\Photos\CCSD Photos\21015453 Photos\DSC_0524.JPG"
- "S:\UDF Team\Lee, Innes\Photos\CCSD Photos\21015453 Photos\DSC_0525.JPG"
- "S:\UDF Team\Lee, Innes\Photos\CCSD Photos\21015453 Photos\DSC_0526.JPG"
- "S:\UDF Team\Lee, Innes\Photos\CCSD Photos\21015453 Photos\DSC_0527.JPG"
- "S:\UDF Team\Lee, Innes\Photos\CCSD Photos\21015453 Photos\DSC_0528.JPG"
- "S:\UDF Team\Lee, Innes\Photos\CCSD Photos\21015453 Photos\DSC_0529.JPG"
- "S:\UDF Team\Lee, Innes\Photos\CCSD Photos\21015453 Photos\DSC_0530.JPG"
- "S:\UDF Team\Lee, Innes\Photos\CCSD Photos\21015453 Photos\DSC_0516.JPG"
- "S:\UDF Team\Lee, Innes\Photos\CCSD Photos\21015453 Photos\DSC_0517.JPG"
- "S:\UDF Team\Lee, Innes\Photos\CCSD Photos\21015453 Photos\DSC_0518.JPG"
- "S:\UDF Team\Lee, Innes\Photos\CCSD Photos\21015453 Photos\DSC_0519.JPG"
- "S:\UDF Team\Lee, Innes\Photos\CCSD Photos\21015453 Photos\DSC_0520.JPG"
- "S:\UDF Team\Lee, Innes\Photos\CCSD Photos\21015453 Photos\DSC_0521.JPG"
- "S:\UDF Team\Lee, Innes\Photos\CCSD Photos\21015453 Photos\DSC_0538.JPG"
- "S:\UDF Team\Lee, Innes\Photos\CCSD Photos\21015453 Photos\DSC_0539.JPG"
- "S:\UDF Team\Lee, Innes\Photos\CCSD Photos\21015453 Photos\DSC_0540.JPG"
- "S:\UDF Team\Lee, Innes\Photos\CCSD Photos\21015453 Photos\DSC_0541.JPG"
- "S:\UDF Team\Lee, Innes\Photos\CCSD Photos\21015453 Photos\DSC_0542.JPG"
- "S:\UDF Team\Lee, Innes\Photos\CCSD Photos\21015453 Photos\DSC_0543.JPG"
- "S:\UDF Team\Lee, Innes\Photos\CCSD Photos\21015453 Photos\DSC_0544.JPG"
- "S:\UDF Team\Lee, Innes\Photos\CCSD Photos\21015453 Photos\DSC_0545.JPG"
- "S:\UDF Team\Lee, Innes\Photos\CCSD Photos\21015453 Photos\DSC_0531.JPG"
- "S:\UDF Team\Lee, Innes\Photos\CCSD Photos\21015453 Photos\DSC_0532.JPG"

CUYAHOGA COUNTY SHERIFF'S DEPARTMENT

- "S:\UDF Team\Lee, Innes\Photos\CCSD Photos\21015453 Photos\DSC_0533.JPG"
- "S:\UDF Team\Lee, Innes\Photos\CCSD Photos\21015453 Photos\DSC_0534.JPG"
- "S:\UDF Team\Lee, Innes\Photos\CCSD Photos\21015453 Photos\DSC_0535.JPG"
- "S:\UDF Team\Lee, Innes\Photos\CCSD Photos\21015453 Photos\DSC_0536.JPG"
- "S:\UDF Team\Lee, Innes\Photos\CCSD Photos\21015453 Photos\DSC_0537.JPG"
- "S:\UDF Team\Lee, Innes\Photos\CCSD Photos\21015453 Photos\DSC_0547.JPG"
- "S:\UDF Team\Lee, Innes\Photos\CCSD Photos\21015453 Photos\DSC_0548.JPG"
- "S:\UDF Team\Lee, Innes\Photos\CCSD Photos\21015453 Photos\DSC_0549.JPG"
- "S:\UDF Team\Lee, Innes\Photos\CCSD Photos\21015453 Photos\DSC_0550.JPG"
- "S:\UDF Team\Lee, Innes\Photos\CCSD Photos\21015453 Photos\DSC_0551.JPG"
- "S:\UDF Team\Lee, Innes\Photos\CCSD Photos\21015453 Photos\DSC_0552.JPG"
- "S:\UDF Team\Lee, Innes\Photos\CCSD Photos\21015453 Photos\DSC_0553.JPG"
- "S:\UDF Team\Lee, Innes\Photos\CCSD Photos\21015453 Photos\DSC_0554.JPG"
- "S:\UDF Team\Lee, Innes\Photos\CCSD Photos\21015453 Photos\DSC_0546.JPG"

Detective Joseph Goudy

- "S:\UDF Team\Lee, Innes\Investigators File\Det. Goudy"
 - "S:\UDF Team\Lee, Innes\Investigators File\Det. Goudy\Screenshot 2021-04-29 132303.png"
 - "S:\UDF Team\Lee, Innes\Investigators File\Det. Goudy\Prosecutor Garrity review Letter.pdf"

Detective Kevin Harvey

- "S:\UDF Team\Lee, Innes\Investigators File\Det. Harvey"

Detective Roger Gibson

- "S:\UDF Team\Lee, Innes\Investigators File\Det. Gibson"

CUYAHOGA COUNTY SHERIFF'S DEPARTMENT

Detective Danney Nukta

- "S:\UDF Team\Lee, Innes\Investigators File\Det. Nukta"S

Detective Randy Divis

- "S:\UDF Team\Lee, Innes\Investigators File\Det. Divis"
 - "S:\UDF Team\Lee, Innes\Investigators File\Det. Divis\Media"
 - "S:\UDF Team\Lee, Innes\Investigators File\Det. Divis\Media\SMachine DN21042814081.pdf"

Cleveland Police Department Files

Reports and Body Camera Information

- "S:\UDF Team\Lee, Innes\Body Camera\4281_E_134__Officer_Involved_Shooting__.mp4"
- "S:\UDF Team\Lee, Innes\Body Camera\4281_E_134_Homicide_Suspect_.mp4"
- "S:\UDF Team\Lee, Innes\Body Camera_Clip_1_1__AXON_Body_2_Video_2021-04-15_0805.mp4"
- "S:\UDF Team\Lee, Innes\Body Camera\13617_Beach_wood__TRUN__Asst_CW_Homicide(1).mp4"
- "S:\UDF Team\Lee, Innes\Body Camera\13617_Beach_wood__TRUN__Asst_CW_Homicide(2).mp4"
- "S:\UDF Team\Lee, Innes\Body Camera\4281_E_134_Off__invol_shooting.mp4"
- "S:\UDF Team\Lee, Innes\Body Camera\4299_E73_Cwell_IR_Buckley__Police_Nor_Ems_Wanted_Checks_Okay.mp4"
- "S:\UDF Team\Lee, Innes\Body Camera\8550_Aetna_Asst_A13_to_handle_.mp4"
- "S:\UDF Team\Lee, Innes\Body Camera\13617_Beachwood__Trun__Assist_W_Scene_Sec__BCI_To_Handle(1).mp4"
- "S:\UDF Team\Lee, Innes\Body Camera\13617_Beachwood__Trun__Assist_W_Scene_Sec__BCI_To_Handle(2).mp4"
- "S:\UDF Team\Lee, Innes\Body Camera\13617_Beachwood__Trun__Assist_W_Scene_Sec__BCI_To_Handle.mp4"

CUYAHOGA COUNTY SHERIFF'S DEPARTMENT

- "S:\UDF Team\Lee, Innes\Body
Camera\13617_Beachwood__Trun__Info__Assist_Crime_Scene_P
erm_On_136(1).mp4"
- "S:\UDF Team\Lee, Innes\Body
Camera\13617_Beach_wood__TRUN__Asst_CW_Homicide.mp4"
- "S:\UDF Team\Lee, Innes\Body
Camera\13617_Beach_wood_Asst_B37_Male_Fled_Utl_Goa.mp4"
- "S:\UDF Team\Lee, Innes\Body Camera\13617_Beachwood_.mp4"
- "S:\UDF Team\Lee, Innes\Body
Camera\13617_Beachwood_Civil_Dispute_Info__Foster__Brown_
_Foster_under__evid_seized.mp4"
- "S:\UDF Team\Lee, Innes\Body
Camera\13617_Beachwood_Homicide_Assisted_With_Victims_Fa
mily.mp4"
- "S:\UDF Team\Lee, Innes\Body
Camera\13617_Beachwood_Troub_Unk_Assist_A18(1).mp4"
- "S:\UDF Team\Lee, Innes\Body
Camera\13617_Beachwood_TRUN_Cw_Homicide_Assisted_With_
Family_A18_Handle.mp4"
- "S:\UDF Team\Lee, Innes\Body Camera\13617_Beachwood-
assist_B37_W__Tour_For_Susp.mp4"
- "S:\UDF Team\Lee, Innes\Body
Camera\13617_Beechwood_Ave_Trunk_Assisted_A18.mp4"
- "S:\UDF Team\Lee, Innes\Body
Camera\13617Beachwood_TrobUnk_Assist4A16Complete.mp4"
- "S:\UDF Team\Lee, Innes\Body
Camera\Assist__4281_E_134__Canvass_Area_for_Witnesses_S
urveillance_Video.mp4"
- "S:\UDF Team\Lee, Innes\Body
Camera\AXON_Body_2_Video_2021-04-15_0721.mp4"
- "S:\UDF Team\Lee, Innes\Body
Camera\13617_Beachwood_Asst_B37.mp4"
- "S:\UDF Team\Lee, Innes\Body
Camera\13617_Beachwood_Ave_IR__Foster__1_male_under_vsd
l.mp4"
- "S:\UDF Team\Lee, Innes\Body
Camera\13617_Beachwood_Ave_Trunk_Unk_Assist_Enag_Woth_Victi
m_Fam.mp4"
- "S:\UDF Team\Lee, Innes\Body
Camera\13617_Beachwood_CD_X_Asst_B36.mp4"
- "S:\UDF Team\Lee, Innes\Body
Camera\CLEANAssist_ZC_C_W_Homicide_Suspect__OIS_4281
_E_134.mp4"
- "S:\UDF Team\Lee, Innes\Body
Camera\CLEANAssist_ZC_C_W_Homicide_Suspect__OIS_4281_
E_134.mp4"

CUYAHOGA COUNTY SHERIFF'S DEPARTMENT

- "S:\UDF Team\Lee, Innes\Body
Camera\CLEANAXON_Body_2_Video_2021-04-15_0805(1).mp4"
- "S:\UDF Team\Lee, Innes\Body
Camera\CLEANAXON_Body_2_Video_2021-04-15_0805(2).mp4"
- "S:\UDF Team\Lee, Innes\Body
Camera\CLEANAXON_Body_2_Video_2021-04-15_0805.mp4"
- "S:\UDF Team\Lee, Innes\Body
Camera\CLEANAXON_Body_2_Video_2021-04-15_0810(1).mp4"
- "S:\UDF Team\Lee, Innes\Body
Camera\CLEANAXON_Body_2_Video_2021-04-15_0810(2).mp4"
- "S:\UDF Team\Lee, Innes\Body
Camera\CLEANAXON_Body_2_Video_2021-04-15_0810.mp4"
- "S:\UDF Team\Lee, Innes\Body
Camera\CLEANE_134_Beachwood_Police_involved_shootg_Coun
ty_to_handle.mp4"
- "S:\UDF Team\Lee, Innes\Body
Camera\CLEANE134_Officer_Involved_Shooting_Asst.mp4"
- "S:\UDF Team\Lee, Innes\Body Camera\CLEANE134_OIS.mp4"
- "S:\UDF Team\Lee, Innes\Body
Camera\CLEAN4281_E_134_Officer_Involved_Shooting__(1).mp4
"
- "S:\UDF Team\Lee, Innes\Body
Camera\CLEAN13617_Beachwood_Fel_Susp_And_Foot_Pursuit.
mp4"
- "S:\UDF Team\Lee, Innes\Body
Camera\CLEAN13617_Beachwood_Male_with_warrant_shots_Ho
micide_IA_.mp4"
- "S:\UDF Team\Lee, Innes\Body
Camera\CLEAN13617_Beachwood_Trouble_Unknown_Officer_Sh
ooting.mp4"
- "S:\UDF Team\Lee, Innes\Body
Camera\CLEANA_O_E_131_Beachwood_Touring_for_Homicide_
Suspect.mp4"
- "S:\UDF Team\Lee, Innes\Body
Camera\E136_Beachwood_Off_Involved_Shoot.mp4"
- "S:\UDF Team\Lee, Innes\Body Camera\Scene.mp4"
- "S:\UDF Team\Lee, Innes\Body
Camera\Start_Video_Inspection_408.mp4"
- "S:\UDF Team\Lee, Innes\Body Camera\Vehicle_Check_.mp4"
- "S:\UDF Team\Lee, Innes\Body Camera\W_134_And_Caine_
_Tour_Area_For_Homicide_Suspect.mp4"
- "S:\UDF Team\Lee, Innes\Body
Camera\E_134___Beacwood_Officer_involved_shootg_Countu_t
o_handle.mp4"

CUYAHOGA COUNTY SHERIFF'S DEPARTMENT

Use of Force Policy

- "S:\UDF Team\Lee, Innes\CPD File\Use of Force Policy\SMachine DN21052812331.pdf"

Police Dispatch Records

- "S:\UDF Team\Lee, Innes\CPD File\Dispatch"
 - "S:\UDF Team\Lee, Innes\CPD File\Dispatch\O400 incident"
 - "S:\UDF Team\Lee, Innes\CPD File\Dispatch\O400 incident\0400 Dispatch Log.pdf"
 - "S:\UDF Team\Lee, Innes\CPD File\Dispatch\O400 incident\0800 Dispatch Log.pdf"
 - "S:\UDF Team\Lee, Innes\CPD File\Dispatch\O400 incident\Monique Call to CPD.wav"
 - "S:\UDF Team\Lee, Innes\CPD File\Dispatch\O400 incident\04-15-21 03.50.33 Cleveland (216) 623-5400 - Station-Integrated-Sip-Polycom-2 (265) (1).wav"
 - "S:\UDF Team\Lee, Innes\CPD File\Dispatch\O400 incident\04-15-21 03.50.45 (440) 511-2415 - Station-Integrated-Sip-Polycom (273).wav"
 - "S:\UDF Team\Lee, Innes\CPD File\Dispatch\Radio Call Logs"
 - "S:\UDF Team\Lee, Innes\CPD File\Dispatch\Radio Call Logs\Phone Calls - Disk #1"
 - "S:\UDF Team\Lee, Innes\CPD File\Dispatch\Radio Call Logs\Phone Calls - Disk #1\Phone calls #1"
 - "S:\UDF Team\Lee, Innes\CPD File\Dispatch\Radio Call Logs\Phone Calls - Disk #1\Phone calls #1\Merged (x500).wav"
 - "S:\UDF Team\Lee, Innes\CPD File\Dispatch\Radio Call Logs\Phone Calls - Disk #2"
 - "S:\UDF Team\Lee, Innes\CPD File\Dispatch\Radio Call Logs\Phone Calls - Disk #2\Phone Calls #2"
 - "S:\UDF Team\Lee, Innes\CPD File\Dispatch\Radio Call Logs\Phone Calls - Disk #2\Phone Calls #2\Merged (x500).wav"
 - "S:\UDF Team\Lee, Innes\CPD File\Dispatch\Radio Call Logs\Phone Calls - Disk #3"
 - "S:\UDF Team\Lee, Innes\CPD File\Dispatch\Radio Call Logs\Phone Calls - Disk #3\Phone Calls #3"
 - "S:\UDF Team\Lee, Innes\CPD File\Dispatch\Radio Call Logs\Phone Calls - Disk #3\Phone Calls #3\Merged (x500).wav"
 - "S:\UDF Team\Lee, Innes\CPD File\Dispatch\Radio Call Logs\Phone Calls - Disk #4"

CUYAHOGA COUNTY SHERIFF'S DEPARTMENT

- "S:\UDF Team\Lee, Innes\CPD File\Dispatch\Radio Call Logs\Phone Calls - Disk #4\Phone Calls #4"
 - "S:\UDF Team\Lee, Innes\CPD File\Dispatch\Radio Call Logs\Phone Calls - Disk #4\Phone Calls #4\Merged (x194).wav"
 - "S:\UDF Team\Lee, Innes\CPD File\Dispatch\Radio Call Logs\Radio Calls"
 - "S:\UDF Team\Lee, Innes\CPD File\Dispatch\Radio Call Logs\Radio Calls\Phone calls #1"
 - "S:\UDF Team\Lee, Innes\CPD File\Dispatch\Radio Call Logs\Radio Calls\Phone calls #1\Merged (x500).wav"
 - "S:\UDF Team\Lee, Innes\CPD File\Dispatch\Radio Call Logs\Radio Calls\4-15-21 CH1-5 1201 to 1159.mp3"
 - "S:\UDF Team\Lee, Innes\CPD File\Dispatch\Radio Call Logs\21-110000.pdf"

CPD Reports

- "S:\UDF Team\Lee, Innes\CPD File\Reports"
 - "S:\UDF Team\Lee, Innes\CPD File\Reports\Crime Scene Report.pdf"
 - "S:\UDF Team\Lee, Innes\CPD File\Reports\Daily Duty Assignments.pdf"

Cleveland Emergency Medical Service

Cleveland Emergency Medical Service Run Reports

- "S:\UDF Team\Lee, Innes\EMS\CAD reports"
 - "S:\UDF Team\Lee, Innes\EMS\CAD reports\4281 E. 134 St. 2.pdf"
 - "S:\UDF Team\Lee, Innes\EMS\CAD reports\4281 E. 134 St..pdf"

Cleveland Emergency Medical Service Interviews

- "S:\UDF Team\Lee, Innes\EMS\Medic Katrina Mcllelland"
 - "S:\UDF Team\Lee, Innes\EMS\Medic Katrina Mcllelland\EMS Mcllelland.MP3"
 - "S:\UDF Team\Lee, Innes\EMS\Medic Katrina Mcllelland\Mcllelland Interview.docx"
- "S:\UDF Team\Lee, Innes\EMS\Medic Jared Venczel"

CUYAHOGA COUNTY SHERIFF'S DEPARTMENT

- "S:\UDF Team\Lee, Innes\EMS\Interview of EMS J. Venczel-21015453-0420134730.zip
- "S:\UDF Team\Lee, Innes\EMS\Medic Jared Venczel\Interview.doc"

Innes Lee (Decedent)

- "S:\UDF Team\Lee, Innes\Lee File"
 - "S:\UDF Team\Lee, Innes\Lee File\Innes Lee Police Reports.pdf"
 - "S:\UDF Team\Lee, Innes\Lee File\Innes Lee.pdf"
 - "S:\UDF Team\Lee, Innes\Lee File\LEE Image.jpg"
 - "S:\UDF Team\Lee, Innes\Lee File\clear report.pdf"
 - "S:\UDF Team\Lee, Innes\Lee File\Juvenile Court Info.pdf"
 - "S:\UDF Team\Lee, Innes\Lee File\Juvenile Court Info2.pdf"

Cleveland Police Officers

Officer Daniel Piper

- "S:\UDF Team\Lee, Innes\Ofc. Daniel Piper #1113"
 - "S:\UDF Team\Lee, Innes\Ofc. Daniel Piper #1113\OHLEG-SE Person Detail_files"
 - "S:\UDF Team\Lee, Innes\Ofc. Daniel Piper #1113\OHLEG-SE Person Detail.html"
 - "S:\UDF Team\Lee, Innes\Ofc. Daniel Piper #1113\Leads Printout.pdf"
 - "S:\UDF Team\Lee, Innes\Body Camera\CPD Piper Personnel File.pdf"
- "S:\UDF Team\Lee, Innes\Ofc. Daniel Piper #1113\Interview"
 - "S:\UDF Team\Lee, Innes\Ofc. Daniel Piper #1113\Interview\Interview.doc"
 - "S:\UDF Team\Lee, Innes\Ofc. Daniel Piper #1113\Interview\Notification Form.pdf"
 - "S:\UDF Team\Lee, Innes\Ofc. Daniel Piper #1113\Interview\UDF- Officer Piper-21015453-0514141316.mp4"

Officer Anthony Lampkin

- "S:\UDF Team\Lee, Innes\CPD File\Officers\Ofc. Anthony Lampkin #2462"
 - "S:\UDF Team\Lee, Innes\CPD File\Officers\Ofc. Anthony Lampkin #2462\Notification Form.pdf"

CUYAHOGA COUNTY SHERIFF'S DEPARTMENT

- "S:\UDF Team\Lee, Innes\CPD File\Officers\Ofc. Anthony Lampkin #2462\UDF Officer Lampkin-21015453-0514130209.mp4"
- "S:\UDF Team\Lee, Innes\CPD File\Officers\Ofc. Anthony Lampkin #2462\Interview.doc"

Officer Fred Brown

- "S:\UDF Team\Lee, Innes\CPD File\Officers\Ofc. Fred Brown #1393"
 - "S:\UDF Team\Lee, Innes\CPD File\Officers\Ofc. Fred Brown #1393\Notification Form.pdf"
 - "S:\UDF Team\Lee, Innes\CPD File\Officers\Ofc. Fred Brown #1393\Officer Fred Brown JR.doc"
 - "S:\UDF Team\Lee, Innes\CPD File\Officers\Ofc. Fred Brown #1393\UDF Officer Brown -21015453-0514134554.mp4"

Officer Juan Cedano

- "S:\UDF Team\Lee, Innes\CPD File\Officers\Ofc. Juan Cedano #483"
 - "S:\UDF Team\Lee, Innes\CPD File\Officers\Ofc. Juan Cedano #483\Notification Form.pdf"
 - "S:\UDF Team\Lee, Innes\CPD File\Officers\Ofc. Juan Cedano #483\UDF-Officer Sedano-21015453-0514134236.mp4"
 - "S:\UDF Team\Lee, Innes\CPD File\Officers\Ofc. Juan Cedano #483\CPD Officer Juan Sedano.doc"

Officer Gino Trinh

- "S:\UDF Team\Lee, Innes\CPD File\Officers\Ofc. Gino Trinh #505"
 - "S:\UDF Team\Lee, Innes\CPD File\Officers\Ofc. Gino Trinh #505\Investigation Notification form.pdf"
 - "S:\UDF Team\Lee, Innes\CPD File\Officers\Ofc. Gino Trinh #505\UDF- Officer Trinh-21015453-0514140900.mp4"
 - "S:\UDF Team\Lee, Innes\CPD File\Officers\Ofc. Gino Trinh #505\Interview.doc"

Sgt. Stephanie May

- "S:\UDF Team\Lee, Innes\CPD File\Officers\Sgt. May"
 - "S:\UDF Team\Lee, Innes\CPD File\Officers\Sgt. May\On 05.docx"

CUYAHOGA COUNTY SHERIFF'S DEPARTMENT

- "S:\UDF Team\Lee, Innes\CPD File\Officers\Sgt. May\Sgt. May-21015453-0506150109.mp4"
- "S:\UDF Team\Lee, Innes\CPD File\Officers\Sgt. May\Interview.doc"

Witnesses

- "S:\UDF Team\Lee, Innes\Witnesses\Interviews\Kali Pace"
 - "S:\UDF Team\Lee, Innes\Witnesses\Interviews\Kali Pace\Kali Pace Witness Statement.pdf"
 - "S:\UDF Team\Lee, Innes\Witnesses\Interviews\Kali Pace\Kali Pace.pdf"
 - "S:\UDF Team\Lee, Innes\Witnesses\Interviews\Kali Pace\UDF Interview - Kali Pace-21015453-0415185610.mp4"
 - "S:\UDF Team\Lee, Innes\Witnesses\Interviews\Kali Pace\Interview Pace.pdf"
- "S:\UDF Team\Lee, Innes\Witnesses\Interviews\Daron Armstrong"
 - "S:\UDF Team\Lee, Innes\Witnesses\Interviews\Daron Armstrong\Daron Armstrong.pdf"
 - "S:\UDF Team\Lee, Innes\Witnesses\Interviews\Daron Armstrong\UDF Interview - Daron Armstrong-21015453.mp4"
 - "S:\UDF Team\Lee, Innes\Witnesses\Interviews\Daron Armstrong\armstrong.pdf"

Cuyahoga County Medical Examiner

- S:\UDF Team

Respectfully Submitted,

Detective Joseph Goudy #12

Detective Roger Gibson #46

Detective Kevin Harvey #343

Detective Danney Nukta #81

Detective Randy Divis #191

Det. Sgt. Steve Bartczak

Google Maps 13614 Beachwood Ave



Image capture: May 2019 © 2021 Google

Cleveland, Ohio

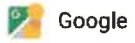

Street View



Google Maps 4281 E 134th St

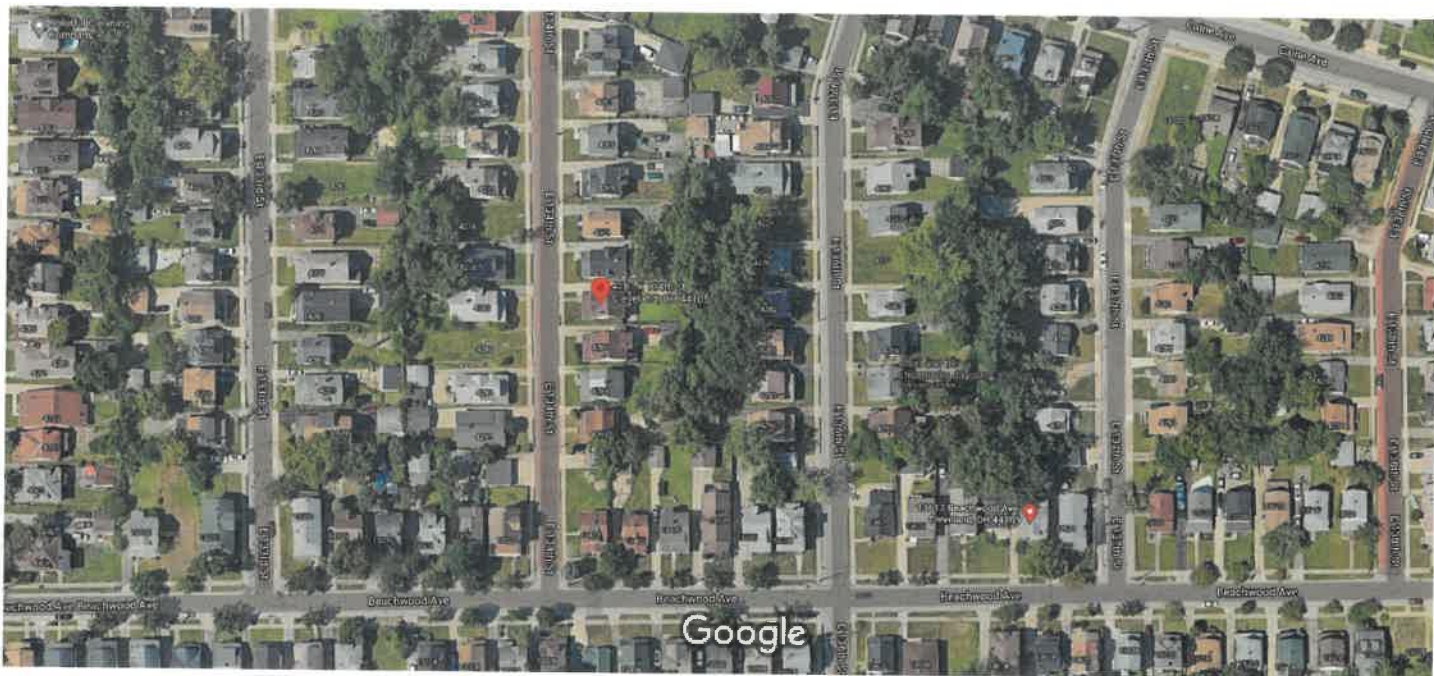

Imagery ©2021 Maxar Technologies, U.S. Geological Survey, USDA Farm Service Agency, Map data ©2021 50 ft



4281 E 134th St

Building



Directions



Save



Nearby



Send to your phone



Share



4281 E 134th St, Cleveland, OH 44105

Photos



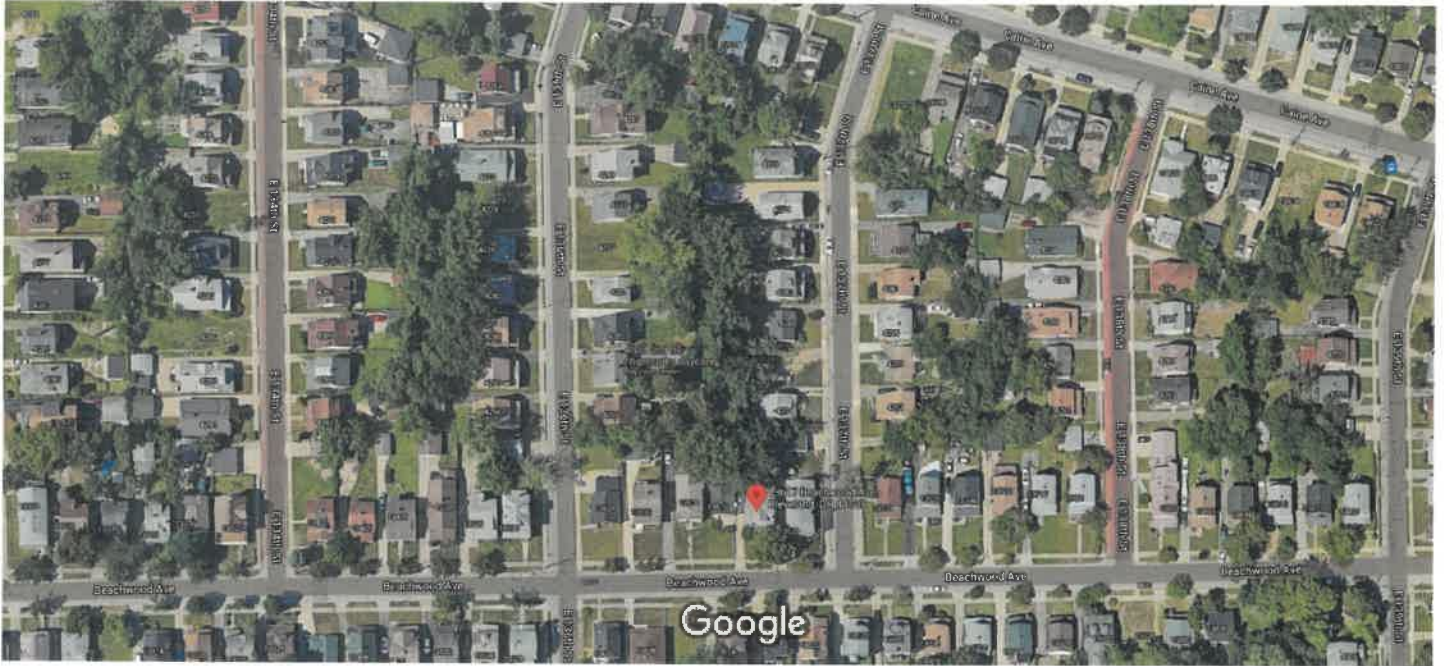

Imagery ©2021 Maxar Technologies, Map data ©2021 50 ft 

CUYAHOGA COUNTY SHERIFF'S OFFICE

FILE NO. 21015453

DATE April 20, 2021

FROM Detective Kevin Harvey

TO Detective Sgt. Bartczak

SUBJECT Neighborhood Canvas

COPIES TO File...

On April 15th, 2021 at approximately 0900hrs, Detectives from the Cuyahoga County Sheriff's Department, Detective Bureau responded to an Officer Involved, Use of Deadly Force at 4281 E. 134th St., Cleveland OH 44105. Upon arrival, Detective Kevin Harvey #343 was assigned to canvass the western side of E. 134th Street. Assisting Detective Harvey was City of Cleveland Division of Police, Internal Affairs Detective Moutezuma #9250.

Houses canvassed in connection with the incident were the following;

4283 E. 134th: Spoke with Brandy Calhoun () who stated that her grandmother Juanita Calhoun () was the homeowner and was unavailable to speak with detectives. It should be noted that this structure had a visible camera in the front bay window.

4278 E. 134th: No answer or camera

4273 E. 134th: Spoke with Patricia Warren () who stated she heard 4 shots. No visible camera on property.

4270 E. 134th: No answer/ No visible camera on property

4289 E. 134th: This property was an abandoned structure, with no visible cameras on the property.

13401 Beachwood: Spoke with Tyrone Anderson () who did not hear anything.

4277 E. 134th: This property was an abandoned structure, with no visible cameras on the property.

4269 E. 134th: Spoke with Ronald Jackson () who heard nothing.

4265 E. 134th: Spoke with Connie Sheffield () who heard 4-5 shots. No visible cameras on property.

4261 E. 134th: No answer/No visible cameras

4257 E. 134th: No answer/No visible cameras.

Respectfully Submitted,

Detective Kevin Harvey

CLEVELAND DIVISION OF POLICE

CLEVELAND, OHIO

DIVISIONAL INFORMATION

DIST. 4 ZONE 4

4-12-21

EXAMINED BY Stephanie Maye 9272 RANK Sgt

4-12-21

FROM P.O. Nicholas Sefcik #539

TO Bruce Cutlip #8476, Lieutenant

SUBJECT **Homicide suspect Innes Lee c/w 2020-274496**

COPIES TO Chief's Office, District Files, Homicide, C.P.P.A.

Sir:

On Monday April 12, 2021 while assigned to the 4th District lobby I had a victim of a felonious assault respond. Shamorra Kindred stated that she was assaulted by Innes Lee, 2021-106220 Felonious Assault/NS. Lee has an active warrant for Murder c/w 2020-274496. Kindred states that Lee threatened to kill her and she is afraid for her and her childrens' lives. Kindred states that Lee is known to stay at the Econolodge and Quality Inn in Willoughby and at a house off Caine Ave. She was not sure of the exact address but states it is on a brick street with a silver Nissan or ~~WW~~ in the driveway. She could point out the house. The assault that she was the victim of occurred on Sandusky but again she didn't know the exact address but could point the house out. Lee was with Lebron Sanford when he assaulted Kindred. She didn't provide any more info about Sanford.

Kindred states that Lee has called her from (216)800-9223 and (216)762-0625 but doesn't believe either is his phone. She believes he does not actually have a phone of his own.

Shamorra Kindred



- Two to Homicide
- Sgt Haver Auburn notified

[Handwritten signature]

Spoke with Keith Haver forwarded via email Sgt. Maye 9272

I also spoke with Sgt. Hoover c/w this incident. No assistance needed

[Handwritten signature] 9272

RECEIVED
APR 12 2021
BY: _____

RESPECTFULLY,

[Handwritten signature]

P.O. Nicholas Sefcik #539



CLEVELAND DIVISION OF POLICE
FIELD CASE REPORT

CASE# 2021-00106220

EVENT	REPORTED DATE/TIME 04/12/2021 01:00	OCCURRED INCIDENT TYPE Menacing	LOCATION OF OCCURRENCE SANDUSKY AVE Cleveland, OH 44105
	OCCURRED FROM DATE/TIME 04/10/2021 03:00	OCCURRED THRU DATE/TIME 04/10/2021 03:00	

OFFENSES	STATUTE/DESCRIPTION	COUNTS	ATTEMPT/COMMIT
	01	2903.21 Aggravated Menacing	1
02	2905.03 Unlawful Restraint	1	Committed

SUBJECT	JACKET/SUBJECT TYPE Adult Victim	NAME (LAST, FIRST, MIDDLE SUFFIX) KINDRED, SHAMORRA					
	DOB [REDACTED] 1998	AGE or AGE RANGE 22	ADDRESS (STREET, CITY, STATE, ZIP) [REDACTED]				
	RACE Black	SEX Female	HEIGHT or RANGE 5'5	WEIGHT or RANGE 188	HAIR Brown	EYE Brown	
	DL NUMBER/STATE	PRIMARY PHONE [REDACTED]	PHONE #2	PHONE #3			

SUBJECT	JACKET/SUBJECT TYPE Adult Witness	NAME (LAST, FIRST, MIDDLE SUFFIX) SANFORD, LEBRON					
	DOB	AGE or AGE RANGE	ADDRESS (STREET, CITY, STATE, ZIP)				
	RACE Black	SEX Male	HEIGHT or RANGE	WEIGHT or RANGE	HAIR	EYE	
	DL NUMBER/STATE	PRIMARY PHONE	PHONE #2	PHONE #3			

SUBJECT	JACKET/SUBJECT TYPE Adult Witness	NAME (LAST, FIRST, MIDDLE SUFFIX) D'AIA,					
	DOB	AGE or AGE RANGE	ADDRESS (STREET, CITY, STATE, ZIP)				
	RACE Black	SEX Female	HEIGHT or RANGE	WEIGHT or RANGE	HAIR	EYE	
	DL NUMBER/STATE	PRIMARY PHONE [REDACTED]	PHONE #2	PHONE #3			

REPORTING OFFICER 0539 Sefcik	DATE 04/12/2021	REVIEWED BY Maye, Stephanie L	04/12/2021
---	---------------------------	---	-------------------



CLEVELAND DIVISION OF POLICE
FIELD CASE REPORT

CASE# 2021-00106220

ADDITIONAL SUBJECTS

SUBJECT	JACKET/SUBJECT TYPE Adult Suspect		NAME (LAST, FIRST, MIDDLE SUFFIX) LEE, INNES, K, Jr				
	DOB 09/12/1995		AGE or AGE RANGE 25		ADDRESS (STREET, CITY, STATE, ZIP) 3677 147TH ST CLEVELAND,		
	RACE Black		SEX Male	HEIGHT or RANGE 5#6	WEIGHT or RANGE 170	HAIR Black	EYE Brown
	DL NUMBER/STATE		PRIMARY PHONE		PHONE #2		PHONE #3

SUBJECT	JACKET/SUBJECT TYPE		NAME (LAST, FIRST, MIDDLE SUFFIX)				
	DOB		AGE or AGE RANGE		ADDRESS (STREET, CITY, STATE, ZIP)		
	RACE		SEX	HEIGHT or RANGE	WEIGHT or RANGE	HAIR	EYE
	DL NUMBER/STATE		PRIMARY PHONE		PHONE #2		PHONE #3

SUBJECT	JACKET/SUBJECT TYPE		NAME (LAST, FIRST, MIDDLE SUFFIX)				
	DOB		AGE or AGE RANGE		ADDRESS (STREET, CITY, STATE, ZIP)		
	RACE		SEX	HEIGHT or RANGE	WEIGHT or RANGE	HAIR	EYE
	DL NUMBER/STATE		PRIMARY PHONE		PHONE #2		PHONE #3

SUBJECT	JACKET/SUBJECT TYPE		NAME (LAST, FIRST, MIDDLE SUFFIX)				
	DOB		AGE or AGE RANGE		ADDRESS (STREET, CITY, STATE, ZIP)		
	RACE		SEX	HEIGHT or RANGE	WEIGHT or RANGE	HAIR	EYE
	DL NUMBER/STATE		PRIMARY PHONE		PHONE #2		PHONE #3

SUBJECT	JACKET/SUBJECT TYPE		NAME (LAST, FIRST, MIDDLE SUFFIX)				
	DOB		AGE or AGE RANGE		ADDRESS (STREET, CITY, STATE, ZIP)		
	RACE		SEX	HEIGHT or RANGE	WEIGHT or RANGE	HAIR	EYE
	DL NUMBER/STATE		PRIMARY PHONE		PHONE #2		PHONE #3

REPORTING OFFICER 0539 Sefcik	DATE 04/12/2021	REVIEWED BY Maye, Stephanie L	04/12/2021
---	---------------------------	---	-------------------



CLEVELAND DIVISION OF POLICE

FIELD CASE REPORT

CASE# 2021-00106220

NARRATIVE

On Monday April 12, 2021 while assigned to the 4th District lobby VIC#1 (Shamorra Kindred) responded to report that she was assaulted.

Kindred states she was at a party on Saturday early morning, approximately 3:00 am when the assault occurred. She did not know the exact address of the house but states she could point it out if she was in the area. While at the party Kindred and another female went to the bathroom to make out. A short time after they got in the bathroom and male started knocking on the door saying he needed to use the bathroom. While he was doing this SUSP#1 (Innes Lee) was also pounding on the door to get in. When Kindred opened the door Lee grabbed her and started yelling at her. He was making threats to kill her and getting in her face. Kindred's friend tried to get between Lee and Kindred to help her out and assist her to leave. While Kindred was attempting to get down the steps to leave Lee grabbed her again and she smacked her across the face. Kindred again tried to leave but Lee kept getting in her face. He then punched her with a closed fist in the right eye and put his hands around her throat and started to strangle her. Kindred states she thought he was going to kill her at that moment. Eventually Lee let her go and she was able to get out of the house. As she was leaving Lee continued to threaten to kill her.

Kindred responded to UH for treatment. She states she had X-rays taken and was given a CT scan. She told the nurse that she was having trouble breathing and they requested she return for follow up. Kindred stated that she was going to go to UH once she left the police station.

Kindred also states that she is afraid for her life and her children's life. She believes that Lee may try to kill her. Lee has an active warrant for Murder through Cleveland PD. 2020-274496

Sgt Cruz took a photo of her injury. MTE 4th dist prop book page 250 line 21
Kindred has other photos of her injury on her cell phone. She was advised to save those for the detectives and prosecutor.
There were no Z/C available to assist Kindred to get a good address on Sandusky
Request 4th Dist det to follow up.

REPORTING OFFICER
0539 Sefcik

DATE
04/12/2021

REVIEWED BY
Maye, Stephanie L

04/12/2021

On April 15, 2021 at approximately 1700 hours Detective J. Goudy and I, (Detective R. Divis) conducted a formal witness interview of Kali Pace at the Cuyahoga County Sheriff's Department's Detective Bureau. This interview was in connection with Cleveland Police Officer Daniel Piper's use of deadly force on Innes Lee that occurred at 4281 E. 134th St. Cleveland Ohio. Detective Goudy read Pace her Miranda rights which Pace acknowledged and agreed to speak to us regarding this incident.

Pace described P-Nut (Innes Lee) as being a; short, fat, black male with a small afro who stays at 4281 E. 134th several days a week. P-Nut was at this address the night of April 14th and Pace believed P-Nut was ingesting cocaine sometime after 10pm. After ingesting cocaine by himself in the basement, P-Nut was acting aggressive and fighting with his girlfriend "Perfect". P-Nut was threatening Perfect over the phone and stated he would beat the fuck out of Perfect and said "Bitch I will kill you". P-Nut was picked up that night by his cousin to go to a balloon release for P-Nut's deceased grandmother. P-Nut returned to 4281 E. 134th Street several times throughout the night to use Daron's phone to try to call Perfect.

Pace stated that on April 15th her day started by waking up between 0600-0800 to "P-Nut" throwing rocks at the window of the house Pace was sleeping at located at 4281 E. 134th St. P-Nut was trying to get into the home while yelling to Pace's boyfriend Daron Armstrong who was also in the home. The morning of April 15th P-Nut entered the side door of the house, went upstairs to the second floor of the home and grabbed Pace's cellphone. P-Nut went into a separate room and was talking to his girlfriend "Perfect" on the phone asking Perfect if his cousin was in jail. P-Nut was not acting himself, Pace noted that he was scared and paranoid and was saying "I'm going to die about this shit". When asked if Pace knew what P-Nut was talking about, Pace responded "No, but I know if someone says they're gonna die about it they're either going to do something dumb and get killed".

Less than five (5) minutes later, P-Nut said the police were looking for him and Daron told P-Nut to run. P-Nut ran out of the house, Pace hid in one room upstairs squatting under a window and Daron hid in another room behind a chair. Pace saw P-Nut run out of the back door and then Pace looked out of the window and saw P-Nut try to hop over a gate but he didn't make it over. P-Nut was just standing there then he drew a black gun out of his right pocket and pointed it towards the cops to try to shoot. Note at this time, Pace motioned reaching towards her right hip to display to Detective Goudy and I how P-Nut retrieved his gun. Pace stated "the cops didn't even have their guns out". When P-Nut figured out he couldn't run anywhere he pulled his gun out according to Pace. Pace stated, "and I know cops are supposed to do what's told, like if a gun gets pointed do your job and that's what ya'll did, ya'll did ya'll job". Pace stated she thought P-Nut was trying to shoot one of the cops because he didn't want to go to jail. Pace ducked down and heard a "pow" believing that P-Nut shot first and she heard an additional two gun shots fired back for a total of three (3) shots. When Pace looked back out of the window she saw P-Nut lying on the ground. Paces saw three (3) cops trying to help P-Nut by pumping his chest, telling P-Nut to "stay with them" and calling EMS.

Pace provided the following additional pertinent information during this interview: Pace had only known P-Nut for approximately one month prior to this event and was not very familiar with Perfect. Pace has seen P-Nut carry a gun in the past and states she has seen P-Nut carry the same gun that she had seen with P-Nut the day of this incident. Pace described the gun as an all-black handgun. Pace knew that P-

On April 15, 2021 at approximately 1435 hours I (Detective R. Divis) removed Kali Pace from her temporary residence of 4281 E. 134th St. Cleveland Ohio in connection with a search warrant obtained by the Cuyahoga County Sheriff's Department. Pace identified herself as Kali Pace, DOB: 03/23/99, SOC: [REDACTED] Pace stated she has been living at this address for one (1) month and had not left the house since the day before. This house belongs to somebody that Pace considers to be an uncle but is of no actual relation named Ron. Pace was the owner of a Volkswagen Passat parked in the driveway of 4281 E. 134th St. as well as the Chevy Astro van parked in front of this address on E. 134th St. Pace identified "Nut" (P-Nut later identified as Innes Lee) as being a friend of her boyfriend Daron Armstrong and stated she had never seen P-Nut before that day. Pace woke up to P-Nut throwing rocks at her window and then he either broke in or used a key to get into the house. P-Nut ran upstairs saying the police were here and Pace went and hid. Pace stated she was upstairs in the room on the left in the back and Daron was in the other room on the left. The night before this incident Pace heard P-Nut arguing with his girlfriend "Perfect" and was threatening her.

At this time of the witness interview it was learned that a gun and drugs were located where Pace and Daron Armstrong were removed from inside of 4281 E. 134th St. I then read Pace her Miranda Rights which she acknowledged and agreed to continue to speak with me regarding these matters. Pace advised Lt. Caraballo and I that the gun and the drugs belong to Daron and that they currently have active cases together as co-defendants as well as a case against each other. Pace states there were drugs in the first room to left upstairs including some jars of weed in the window and an AR-15 pistol behind the couch. Pace stated Daron's money was in his jacket on the bed and there was cocaine that had been cut with another substance upstairs in a box of movies. Pace stated that both Daron and P-Nut sell drugs and P-Nut carries a gun. P-Nut carries a small black gun and it is always the same gun that he has with him. Daron told P-Nut to run so P-Nut ran and then a few seconds later Pace heard shooting so she stayed where she was at. Pace was hiding in the second bedroom on the left and was peeking out of the window when she saw P-Nut turn around and pull the gun out "when he tried to shoot you guys". Pace reiterated that P-Nut drew a gun in an attempt to get away and stated "my uncle is a police officer I know ya'll don't draw your weapons unless somebody drawing a weapon at ya'll therefore ya'll did ya'lls self defense shit ya'll gotta live ya'll life too". The next thing Pace saw was P-Nut lying on the ground and Pace continued hiding in the same place. Pace later checked on Daron in the other room, Daron did not witness the incident but he told Pace that he thought his friend was dead. Please refer to body camera footage for further details.

Nut had the gun when he came into the house that day because he always carried a gun. P-Nut was acting crazy saying that he was going to kill his girlfriend and was fighting with his girlfriend the night before. P-Nut was fighting over the phone with his girlfriend Perfect and threatened to go over Perfect's house which was around the corner. Perfect was threatening to have people do something to P-Nut or shoot him and P-Nut was threatening to beat her up. Perfect told P-Nut she was going to call the cops on him so Pace told P-Nut to leave her alone. P-Nut stays at 4281 E. 134th for days at a time and has been doing so since March. Pace does not know how P-Nut got in the house; he might have used a key. Pace continued to describe the previous day's events which included additional fights between P-Nut and Perfect. Please refer to body camera footage for further details.

On May 11, 2021 at approximately 1419 hours I, (Detective R. Divis #191) contacted Catrina Mclelland on her cell phone at [REDACTED] to conduct a phone interview. A phone interview was conducted due to Mclelland's recent medical leave and inability to leave her fire station as she was on temporary light duty as well as the attempt to contain the spread of the coronavirus. Mclelland identified herself over the phone and confirmed her birthdate as [REDACTED] 1976. Mclelland works for the Cleveland EMS Public Department of Public Safety as a paramedic. Mclelland has been a paramedic for Cleveland EMS for approximately five (5) years and is partnered with Cleveland EMS Jared Venczel. Venczel has been Mclelland's partner for three (3)- four (4) years. Mclelland worked 04/15/21 from 0700-1900 with her regular partner Jared Venczel, and recalls responding to an address off of E. 134th St. for a male with a "GSW" or gunshot wound. Mclelland was in her squad at medic 11 which is located near Broadway and Fleet Avenue when she received notes that the male was in a residential backyard. This call was sometime near the start of Mclelland's shift but she does not recall the time. Upon arrival to the scene there was a heavy presence of local law enforcement and several officers were placing up yellow caution tape to set the perimeter of the call. Mclelland and Venczel grabbed their equipment and were directed to the backyard of a residential home. There was a male with several penetrating wounds to his body, cpr was in progress and it appeared that law enforcement had attempted to use triage equipment to stop bleeding. Mclelland and Venczel took over and applied a monitor to the patient (Innes Lee). Mclelland recalls the patient having a penetrating wound to the head, chest and leg. The patient had injuries incompatible with life as it appeared on the cardiac monitor. Mclelland announced the patient dead on arrival based on the three lead which detects electrical conduction from the heart. The patient was an African American male in his early twenties (20s), with a sheared shirt and possibly blue jeans. The patient did not have a pulse, his airway was compromised from blood and his tongue was protruded and very large. Mclelland notified the red center (dispatch center) and Captain Kavouros that the male was pronounced dead. Mclelland did not provide any medical services because there were no life saving measures to be taken given his injuries. Mclelland was on scene for a long time but was only with the patient for approximately ten (10) to fifteen (15) minutes. Mclelland felt it was important to preserve the integrity of the scene for any ongoing investigation due to the heavy presence of law enforcement. Please refer to audio recording for further details.

CUYAHOGA COUNTY SHERIFF'S OFFICE

FILE NO. 21015453

DATE 05/14/2021

FROM Detective Gibson

TO Sgt. Bartchek

SUBJECT Interview of CPD Officer Fred Brown Jr.

COPIES TO File

On 05/14/21 at 1211 hrs, Detective Gibson and I, Detective Goudy, conducted an interview with Cleveland Police Officer Fred Brown Jr. in reference to the Use of Deadly Force, Officer Involved Shooting that occurred on April 15, 2021. The incident occurred at 4281 East 134th Street in the City of Cleveland. Officer Brown is, and was assigned to the Patrol Unit at the time of the incident. Brown and Castiglione were working normal shift time 7a-3p with rotating days off and assigned cruiser #414. Officer Brown stated the weather was daylight, colder. Officer Brown was wearing his Cleveland Police uniform and carried his duty weapon with one round in the chamber and a full 15 round magazine in the gun. In addition Brown also carries two extra 17 round magazines loaded with 9mm ammunition.

Officer Brown stated he and Officer Castiglione started their shift by going to an alarm call and then another zone car called out with a vehicle on Edna rd. to assist them. As we pulled up to Edna Rd. we turned our body cameras on and heard the radio traffic about the male the night shift was looking for was in the area of eE.138 and Beachwood. Officer Brown stated they toured they area, 7 different streets looking for the male from E.130th to E.136th. Eventually we saw the other cars get out to check, we were on Caine rd about to turn down I think E.132. Then we saw Officer Piper and other cars pull and we could tell they are about to get out. Officers on scene then called out over the radio that they were going to check this address. Sgt. May was relaying information to us over the radio from a third party saying Innes Lee might be at this address. So Officer Castiglione and I started to go one street east I think E.134. As we got out of our cars we heard over the radio that he is running east so we started to run so hopefully we could catch him on the other side of the fence. Then we heard shots fired and my partner Castiglione yelled get to cover and I ran back to my cruiser, then I heard Officer Piper over the radio say "shots fired, roll EMS". I told Castiglione to grab the first aid kit because he had the keys; we ran over to the area and jumped the fence into the backyard. When I jumped over I saw a male on the ground, we started first aid/cpr to the best of our ability and switched out people with chest compressions. Officer Brown stated he was originally told about Lee through roll call. Before the shooting I heard our Sgt. Calling over the radio address that he could possibly be at. I know that I called over the radio that shots were fired but I do not know if it went over the radio or not.

Officer Brown stated when he first saw the male he was on the ground wearing a gray hoodie and blue jeans with his shirt up. Medical treatment was being administered immediately, Officer Brown never saw the gun in the backyard, Brown remembers Officer Piper saying he has the suspects gun in his pocket; Officer Piper told him and pointed a gun at me. Officer Brown does not recall hearing the suspect say anything. Officer Brown said he did not fire any shots and stated that it was scary to hear the shots fired but he didn't feel like he was being fired upon. Officer Brown stated he was well rested and did not work 48 hours before his shift the day of the incident.

(Please refer to the audio and video interview conducted with CPD Officer Daniel Piper for further detail.)

Respectfully Submitted,

Detective Roger Gibson #46

CUYAHOGA COUNTY SHERIFF'S OFFICE

FILE NO. 21015453

DATE April 20, 2021

FROM Detective Randy Divis

TO Detective Sgt. Bartczak

SUBJECT Interview - EMT Jared Venczel

COPIES TO File...

On 04/20/2021 at approximately 0930 hours I (Detective R. Divis) along with Detective Kevin Harvey interviewed Cleveland EMS Medic Jared Venczel on Cuyahoga County Sheriff's Department's sixth floor Detective Bureau in connection with the Cleveland Police Use of Deadly Force that occurred on 04/15/2021. Venczel has been employed by Cleveland EMS for approximately five and a half years and estimated to have responded to over one hundred (100) fatalities. Venczel's badge number is #138 and he was assigned to medic vehicle M11 on 04/15/21 with his partner of three years, Catrina Mclelland. Venczel and Mclelland were scheduled to work at Cleveland firestation #11 on Thursday 04/15/21 from 0700 hours to 1900 hours. Venczel recalls being contacted that day on an ambulance phone by his dispatch center and advised of a person suffering from gunshot wounds on E 134th St. Venczel was advised to stage for police and upon arrival Venczel noted the street was blocked on the north and south end by police. Venczel was staged at the north end of the street for several minutes and was then escorted by police to the scene.

Venczel was escorted by several uniformed police officers to a backyard where a male in a hooded sweatshirt and jeans, approximately twenty-five (25) years old was laying supine (upward) with several penetrating injuries incompatible with life. Venczel noted there was no sign of life in this male, he had no movement, no heartrate, no respiration and his airway was compromised. Venczel described three (3) penetrating injuries that he noted including one (1) to the left cheek, one (1) to the left side of the chest, and one (1) to the back of the right leg. Venczel noted extreme blood loss, significant facial trauma and what Venczel believed to be damage to the brain. Venczel did not want to disturb the scene as he noted there were no medical services that could be provided and that the patient was declared dead on scene. Venczel and Mclelland were with the patient for approximately two (2)- five (5) minutes and were unable to identify the patient. Mclelland completed the report using the name "John Doe" for the patient. In addition to Venczel and Mclelland, Cleveland EMS Captain Kavourus responded as well.

(Please refer to the audio and video interview conducted with CPD Sgt Stephanie May for further detail.)

Respectfully Submitted,

Detective Randy Divis

CUYAHOGA COUNTY SHERIFF'S OFFICE

FILE NO. 21015453

DATE May 14, 2021

FROM Detective Joseph Goudy

TO Detective Sgt. Bartczak

SUBJECT Interview - CPD Officer Anthony Lampkin

COPIES TO File...

On 05/14/21 at approximately 1045 hrs, Detective Gibson and I, Detective Goudy, conducted an interview with Cleveland Police Officer Anthony Lampkin. Officer Lampkin was accompanied to the interview by CPPA Director Jeff Follmer. Officer Lampkin, badge #2462, is currently assigned to the fourth district working first shift, 0700 to 1500 hrs, with rotating days off. On the day of the incident, Officer Lampkin was working his scheduled shift and assigned to patrol his zone. He stated the weather was a little rainy on the day of the incident.

Officer Lampkin stated him and his partner, Officer Cedeno, were briefed by the previous shift about a male (Lee) who had a homicide warrant, and fled from them earlier in the morning on the previous shift. During the shift, Officer Lampkin stated Officers received a call from dispatch to respond to E. 136 and Beechwood in reference to the male that fled previously. The male was believed to be in the area again. Officers Lampkin and Cedeno, along with other officers, arrived in the area and met up to brief on the situation with the male. After the briefing was over, Officer Lampkin stated they toured the area looking for the male. They did not locate the male. Officer Lampkin stated they received further information that the male may be located at 4281 East 134th Street.

Upon arrival on the street, Officer Lampkin stated Officers Piper and Trinh arrived with them near the residence. Officer Lampkin stated Officer's Piper and Trinh began walking toward the driveway. As they approached the driveway, Officer Lampkin stated they heard what sounded like a screen door shutting. At that point, Officer Lampkin stated Officer Trinh alerted him that the male (Lee) was running. At that point, Officer Lampkin stated, Officer Trinh ran back to his vehicle while Officer Piper ran up the driveway. Officer Lampkin stated he ran up the driveway of the neighbor's residence when he saw Lee try to climb up and over the fence in attempt to cut him off. When Officer Lampkin saw that Lee was not able to make it over the fence, he ran back around the residence to go up the driveway of 4281.

As Officer Lampkin ran up the driveway and into the backyard, he heard Officer Piper yell "gun" followed by several shots. He observed the male (Lee) get struck. As the male (Lee) got struck, the firearm that was in his right hand flung out and landed on the ground. Officer Lampkin stated at that point, Officer Piper radioed dispatch, "Male shot" and to send EMS. Immediately thereafter, Officer Lampkin stated they began to perform first aid on the male (Lee).

(Please refer to the audio and video interview conducted with CPD Officer Anthony Lampkin for further detail.)

Respectfully Submitted,

Detective Joseph Goudy #12

CUYAHOGA COUNTY SHERIFF'S OFFICE

FILE NO. 21015453

DATE May 14, 2021

FROM Detective Joseph Goudy

TO Detective Sgt. Bartczak

SUBJECT Interview - CPD Officer Daniel Piper

COPIES TO File...

On 05/14/21 at 1211 hrs, Detective Gibson and I, Detective Goudy, conducted an interview with Cleveland Police Officer Daniel Piper in reference to the Use of Deadly Force, Officer Involved Shooting that occurred on April 15, 2021. The incident occurred at 4281 East 134th Street in the City of Cleveland. Officer Piper is, and was at the time of the incident, assigned to the Community Policing Unit. Officer Piper was working with his partner, Officer Gino Trinh and they were assigned to marked unit #408. The normal shift time for Officers Piper and Trinh is 9a to 5p with rotating days off between Friday and Saturday or Sunday and Monday. On the day of the incident, Officers Piper and Trinh started their shift at 0600 hrs due to assisting the vice unit and swat team with search warrants. Officer Piper stated they received notice the night before that the operation was cancelled and was still given the opportunity to work 6a-2p on the regular assignment. Officer Piper stated the weather during the time of the incident was overcast and cloudy. Officer Piper was wearing his standard Cleveland Police Uniform and carried his duty weapon with one round in the chamber and a full 15 round magazine in the gun. In addition, Officer Piper was also carrying 3 additional 17 round magazines which were also fully loaded with 9 mm ammunition.

Officer Piper stated he and Officer Trinh started their shift in the area of E. 65th Street and Fleet Avenue in reference to a complaint they received pertaining to illegal drug activity and prostitution. While investigating that complaint, Officer Piper stated they heard the radio traffic about a male that night shift was previously looking for was located in the area of E. 134th Street and Beachwood Avenue. The male was wanted on homicide and felonious assault warrants. Officer Piper stated he said to Officer Trinh, "let's go up there to assist them and see if we can help find this guy." When Officer Piper and Trinh arrived in the area, they met up with the responding zone cars. Shortly thereafter, Officer Piper stated, they received an address and description of the house the male frequents. Officer Piper stated when they arrived on the street, Officer Trinh was driving, and they drove by the house once and didn't see anything initially except a car in the driveway. When they went back around, they parked the car near the address. Just before they reached the driveway, Officer Piper stated he heard a door closing sound coming from the address they were given. When Officers Piper and Trinh approached the driveway, they saw the male run from the back of the house towards the backyard. Officer Piper stated he originally saw a picture of the male on his mobile data terminal (MDT) prior to exiting his marked unit and the male running from behind the house matched the photo he previously seen.

At this point, Officer Piper stated he alerted dispatch that the male was seen running through the backyard. At this point, Officer Piper stated he began to run up the driveway and into the backyard area where the male was located. Officer Piper stated Officer Trinh ran back to the marked unit to drive around to the other street to prevent the male from eluding capture. As Officer Piper entered the backyard, he saw the male trying to climb up and over the back fence of the property. Officer Piper stated he told the male to get down. At this point, Officer Piper stated it appeared as if the male could not get over the fence. When the male got off the fence, he began to reach into his pocket. Officer Piper stated he told the male to stop reaching. It appeared to Officer Piper that the male could not get whatever he was reaching for in his pocket out right away. At this point, Officer Piper removed his duty weapon from his holster. Officer Piper stated he attempted to get closer to the male to grab him. As Officer Piper attempted to grab the male, the male spun around. After the male spun around, Officer Piper pushed him away to get some distance. As Officer Piper pushed the male away, the male pulled a gun out of his pocket. The male was approximately 3 to 6 feet away. At this point, Officer Piper stated he then fired 4 rounds at the male from his duty weapon. The male went down and Officer Piper notified dispatch of shots being fired and that the male was down. In addition Officer Piper requested EMS to respond.

After the shooting occurred, Officer Piper stated he advised other officers that responded to the backyard to get a first aid kit. Officer Piper stated he then secured the male's gun by placing it in his right cargo pant pocket. Officers immediately

CUYAHOGA COUNTY SHERIFF'S OFFICE

began first aid on the male until EMS arrived. When asked if the male fired any rounds, Officer Piper replied, "he did not believe so." Officer Piper stated he was in fear of his life when the male began to point the gun at him.

(Please refer to the audio and video interview conducted with CPD Officer Daniel Piper for further detail.)

Respectfully Submitted,

Detective Joseph Goudy #12

CUYAHOGA COUNTY SHERIFF'S OFFICE

FILE NO. 21015453

DATE May 14, 2021

FROM Detective Joseph Goudy

TO Detective Sgt. Bartczak

SUBJECT Interview - CPD Officer Gino Trinh

COPIES TO File...

On 05/14/21 at 1140 hrs, Detective Gibson and I, Detective Goudy, spoke with Cleveland Police Officer Gino Trinh, badge #505 in reference to the officer involved shooting incident that occurred on April 15, 2021. Officer Trinh stated his appointment date with the City of Cleveland Division of Police was January of 2019. Officer Trinh is currently assigned to the community policing unit working the 9a-5p shift with Sundays and Mondays off. Officer Trinh's partner is Officer Daniel Piper. On the day of the incident, Officer's Trinh and Piper were assigned to marked unit #408. Officer Trinh described the day as to being cloudy and chilly with occasional snow. Officer Trinh stated he was in a standard Cleveland Police uniform on the day of the incident and carried his weapon with one round in the chamber along with a full magazine positioned inside his duty weapon. In addition, he was carrying his two issued magazines, which were fully loaded with 9mm ammunition.

Officer Trinh stated he and Piper started patrolling a certain area. While doing so, they heard the night shift sergeant saying over the Cleveland Police radio channel 4, a male with a warrant and possibly armed is at a certain location. Officer Trinh stated he then asked Piper if he wanted to go and assist with looking for the guy. Officer Piper said yes and they went over to meet with the other zone cars to formulate a plan to look for the male. After meeting with the other zone cars, Officers Trinh and Piper responded to the area of E. 134th and Beachwood area to look for the male. While other units went to the house where he was last seen, Trinh and Piper drove around the block to potentially cut him off due to hearing over the radio the male was known to run. After circling the block a few times, they couldn't locate the male. At one point, they received information stating the male has been known to stay at a particular address along with a description. Officer Trinh stated they drove by the house once and circled back to check on it.

Officer Trinh stated when they arrived at the house; they pulled up one house away. When he and Piper exited their vehicle they walked over to the driveway. As they reached the driveway, Officer Trinh stated he heard a "security door" open and close. When they looked down the driveway, Officer Trinh stated he saw the male. Officer Piper stated to Officer Trinh that it was the male. As Officer Piper ran down the driveway, Officer Trinh ran back to their zone car and advised Officer Lampkin, the male is running. Officer Trinh stated his intentions were to drive around the block to cut the male off from running. Just before Officer Trinh was able to get into the vehicle, he heard shots fired. At this point, Officer Trinh stated he heard Officer Piper over the radio say "Shots fired." After Officer Trinh heard the shots fired, he ran down the driveway and saw Officer Piper either over the male or retrieving the handgun. Officer Trinh stated Officer Piper told him to get the first aid kit.

Immediately after retrieving the first aid kit, Officer Trinh began first aid. Officer Trinh along with the other officers were switching on and off with the rendering of CPR and first aid on the male. EMS was notified to respond as well. Officer Trinh stated just before he was about to start doing first aid on the male, he saw the males handgun on the ground. At that point, Officer Trinh stated he saw Officer Piper retrieve the handgun off the ground, make it safe and secured it in his cargo pant pocket. Officer Trinh stated he was in fear of Officer Piper's life at the time when he heard the shots fired.

(Please refer to the audio and video interview conducted with CPD Gino Trinh for further detail.)

Respectfully Submitted,

Detective Joseph Goudy #12

CUYAHOGA COUNTY SHERIFF'S OFFICE

FILE NO. 21015453

DATE 05/14/2021

FROM Detective Gibson

TO Sgt. Bartchek

SUBJECT Interview of CPD Officer Juan Sedano

COPIES TO File

On 05/14/21 at 1211 hrs. Detective Gibson and I, Detective Goudy, conducted an interview with Cleveland Police Officer Juan Cedano in reference to the Use of Deadly Force, Officer Involved Shooting that occurred on April 15, 2021. The incident occurred at 4281 East 134th Street in the City of Cleveland. Officer Cedano at the time of the incident was assigned to the Patrol division. Officer Cedano was working with his partner Officer Lampkin. Officer Cedano described the weather as cold, rainy and cloudy. Officer Cedano was wearing his standard Cleveland Police Uniform and carried his duty weapon with one round in the chamber and a full 15 round magazine in the gun. In addition, Officer Cedano was also carrying 3 additional 17 round magazines which were also fully loaded with 9 mm ammunition.

Officer Cedano stated he received radio call saying the guy they were looking for was walking down the street, E.134st he thinks. Cedano stated that before they arrived on scene they met up with other Officers to talk about a plan because the suspect has a murder warrant and is known to be armed and ran away from night shift. Then Sgt. May came over the radio and gave us an exact address of where the suspect was. When we arrived on scene my partner and I went to the Southside of the house and Piper went up the driveway. Officer Cedano stated he thinks Officer Piper was the first to see the suspect because he could here he say he's running east. Officer Cedano stated when he came running around the house he heard the shots fired and saw the guy on the floor. Officer Cedano stated when he got the driveway he heard the shots fired. Officer Cedano stated Lampkin was in front of me and as soon as I saw the guy on the floor I went to grab the first aid kit. We all worked on the guy taking turns and switching. Officer Cedano stated once EMS arrived they pronounced him dead right there.

Officer Cedano stated he was notified through radio transmission to respond in the area of the incident and then more Officers responded to help. Radio was giving us directions of where the suspect was. Officer Cedano stated he heard officers saying he's running and then heard shots fired over the radio. Officer Cedano stated he parked a few house's south of the incident area. Officer Cedano described the suspect as a black male, 240lbs and 5ft 8inches tall. Officer Cedano stated that the suspect was trying to get away and trying to shot Officer Piper. Officer Cedano stated the suspect did have a weapon. Officer Cedano stated he did not think the suspect was able to fire his weapon. Cedano stated that the suspect's weapon was collected but he doesn't know where it went. Officer Cedano stated after the shooting we conducted CPR on the suspect. Officer Cedano stated he was rested and did not work any other shifts 48 hours prior to the incident date.

(Please refer to the audio and video interview conducted with CPD Officer Daniel Piper for further detail.)

Respectfully Submitted,

Detective Roger Gibson #46

CUYAHOGA COUNTY SHERIFF'S OFFICE

FILE NO. 21015453

DATE May 6, 2021

FROM Detective Randy Divis

TO Detective Sgt. Bartczak

SUBJECT Interview - CPD Sgt Stephanie May

COPIES TO File...

On 05/06/21 at approximately 1130 hours I, (Detective R. Divis) along with Detective R. Gibson interviewed Cleveland Police Sergeant Stephanie May in the presence of Cleveland Police Captain Bentley at the Cuyahoga County Sheriff's Department's Detective Bureau conference room in connection with the Cleveland Police use of deadly force on April 15, 2021. Sgt. May has been a member of the Cleveland Police Department for approximately twenty (20) years. Sgt. May's shift began on 04/14/21 at 2200 hours and was scheduled to go until 04/15/21 at 0800 hours.

Sgt. May recalled a zone car responding to 13617 Beachwood for a civil dispute where a male refused to leave. Officers responded and were met by two (2) males which unbeknownst to Cleveland police were Innes Lee and his cousin Isaac Foster. Lee stated they were at their auntie's house and their auntie was not answering the door. While police were talking to Isaac Foster, Innes Lee fled from the police and jumped over a fence. The homeowner of 13617 "Monique" wanted to go undetected according to Sgt. May and began screaming at the police at her doorstep in an attempt to mask her calling the police to Innes Lee and Isaac Foster. Isaac Foster was arrested by Officer Luongo and Officer Moyano for possession of a firearm and drugs in an illegally parked vehicle outside of Monique's home. Officers Luongo and Moyano explained to Sgt. May that Monique wished to speak with her. Sgt. May called Monique and Monique explained very explicit details about Innes Lee to Sgt. May including the fact that Innes Lee was the suspect that shot a woman named "Kay Kay". Sgt. May states she dealt with Innes Lee two (2) days prior where a female came into the district to complain about Innes Lee. A police report was taken and Sgt. May forwarded Innes Lee's information up to the commander's office so when Sgt. May heard the name Innes she knew it was the same homicide suspect. Monique told Sgt. May that she had a gun for her protection and she would use it if she had to because Innes Lee told Monique that he would be back. Monique's daughter advised Monique that Innes was at a certain address so Monique looked up the address and Sgt. May made sure that each Cleveland Police roll call was aware of this incident.

At approximately 0800 hours Monique called Sgt. May to state Innes Lee was back at her house, Monique was crying and in fear. Monique did know that Innes carries a gun though she did not specifically see it that night. Innes Lee told Monique that he had nothing to lose and Monique pleaded for Innes to leave. Sgt. May advised Monique to lay down and not look outside, Monique described Innes Lee as wearing a hooded sweatshirt with his hood up. Sgt. May broadcasted this information including the homicide warrant for Innes Lee over the radio as well as notified Lt. Petranick, Lt. Strong, Captain Edens and Sgt. Allen in person. Monique googled an address and provided it to Sgt. May who passed it on to day shift CPD officers which is where Innes Lee was located. A perimeter was set up around the location provided by Monique. Monique blames herself for Lee's death but Sgt. May states that Innes was on a mission. Monique's daughter had broken off a relationship with Innes Lee which is why Lee went to Monique's house. Sgt. May stated that Lee and Foster acted as if they did not know each other at the scene of 13617 Beachwood but they were knocking on the door so loud that neighbors could hear them.

(Please refer to the audio and video interview conducted with CPD Sgt Stephanie May for further detail.)

Respectfully Submitted,

Detective Randy Divis

On 05/06/21 at approximately 1130 hours I, (Detective R. Divis) along with Detective R. Gibson interviewed Cleveland Police Sergeant Stephanie May in the presence of Cleveland Police Captain Bentley at the Cuyahoga County Sheriff's Department's Detective Bureau conference room in connection with the Cleveland Police use of deadly force on April 15, 2021. Sgt. May has been a member of the Cleveland Police Department for approximately twenty (20) years. Sgt. May's shift began on 04/14/21 at 2200 hours and was scheduled to go until 04/15/21 at 0800 hours. Sgt. May recalled a zone car responding to 13617 Beachwood for a civil dispute where a male refused to leave. Officers responded and were met by two (2) males which unbeknownst to Cleveland police were Innes Lee and his cousin Isaac Foster. Lee stated they were at their auntie's house and their auntie was not answering the door. While police were talking to Isaac Foster, Innes Lee fled from the police and jumped over a fence. The homeowner of 13617 "Monique" wanted to go undetected according to Sgt. May and began screaming at the police at her doorstep in an attempt to mask her calling the police to Innes Lee and Isaac Foster. Isaac Foster was arrested by Officer Luongo and Officer Moyano for possession of a firearm and drugs in an illegally parked vehicle outside of Monique's home. Officers Luongo and Moyano explained to Sgt. May that Monique wished to speak with her. Sgt. May called Monique and Monique explained very explicit details about Innes Lee to Sgt. May including the fact that Innes Lee was the suspect that shot a woman named "Kay Kay". Sgt. May states she dealt with Innes Lee two (2) days prior where a female came into the district to complain about Innes Lee. A police report was taken and Sgt. May forwarded Innes Lee's information up to the commander's office so when Sgt. May heard the name Innes she knew it was the same homicide suspect. Monique told Sgt. May that she had a gun for her protection and she would use it if she had to because Innes Lee told Monique that he would be back. Monique's daughter advised Monique that Innes was at a certain address so Monique looked up the address and Sgt. May made sure that each Cleveland Police roll call was aware of this incident. At approximately 0800 hours Monique called Sgt. May to state Innes Lee was back at her house, Monique was crying and in fear. Monique did know that Innes carries a gun though she did not specifically see it that night. Innes Lee told Monique that he had nothing to lose and Monique pleaded for Innes to leave. Sgt. May advised Monique to lay down and not look outside, Monique described Innes Lee as wearing a hooded sweatshirt with his hood up. Sgt. May broadcasted this information including the homicide warrant for Innes Lee over the radio as well as notified Lt. Petranick, Lt. Strong, Captain Edens and Sgt. Allen in person. Monique googled an address and provided it to Sgt. May who passed it on to day shift CPD officers which is where Innes Lee was located. A perimeter was set up around the location provided by Monique. Monique blames herself for Lee's death but Sgt. May states that Innes was on a mission. Monique's daughter had broken off a relationship with Innes Lee which is why Lee went to Monique's house. Sgt. May stated that Lee and Foster acted as if they did not know each other at the scene of 13617 Beachwood but they were knocking on the door so loud that neighbors could hear them.

Cuyahoga County Juvenile Court

1 jic

People Cases Scheduling Service Community Control Support Intake Detention Accounting Reports Admin Log out

Innes Lee

DOB: 09/12/1995

Gender: Male

Age: 25

Race: Black or African American

CCO:

Names → Contact Information → Additional Information → Physical Description → Family Tree → SOGIE Information → Summary

View/Modify Person

Person Summary Report

Names

Primary Name

Last:	Lee	Suffix:	Jr.	First:	Innes	Middle:	Inmate Number:
-------	-----	---------	-----	--------	-------	---------	----------------

Alias Name(s)

Last	Suffix	First	Middle
Lee		Ennis	K
FOSTER		INNES	
LEE		INNES	

[Modify this section](#)

Contact Information

Addresses

Address 1: 9916 Mount Auburn Ave Apt Number:

Address 2:

City: Cleveland State/Province/Region: OH Zip Code: 44104 Country: UNITED STATES
 County: Cuyahoga CensusBlock: 2002 CensusTract: 120200

Primary Private Unknown

Address 1: 1311 E 92ND ST Apt Number: 4

Address 2:

City: CLEVE State: OH Zip Code: 44106 Country: United States
 County: CensusBlock: CensusTract:

Primary Private Unknown

Address 1: 4134 E 127TH ST Apt Number:

Address 2:

City: CLEVELAND State: OH Zip Code: 44105 Country: United States
 County: CensusBlock: CensusTract:

Primary Private Unknown

Address 1: 11717 Princeton Ave Apt Number:

Address 2:

City: Cleveland State: OH Zip Code: 44105 Country: UNITED STATES
 County: Cuyahoga CensusBlock: 2006 CensusTract: 121100

Primary Private Unknown

Phone Number(s)

Phone Number	Type
(216)240-5893	Home
(216)704-5357	Home

Email:

[Modify this section](#)

Additional Information

Status: Active

SS Number: 289980903 DOB: 09/12/1995

Birth City: Birth State:

Religion:

DL Number TU722451 Issue Date: Exp Date: 06/08/2012 State: OH

State Id

In Custody Of: Order Date:

Committed To: Protective Supervision

School:

School Status: Grade:

Source of Income:

Marital Status:

Twin

Crossover Status: Non-participant FSS (Fugitive Safe Surrender):

Crossover Date: FSS Date:

Notes:

Modify this section

Physical Description

Gender: Male Race: Black or African American Height: 5 FT 4 IN

Weight: 145 Eye Color: Brown Hair Color: Black

Distinguishing Marks:

DNA Processed DNA Processor: Processed Date:

Handicapped

Modify this section



People Cases Scheduling Service Community Control Support Intake Detention Accounting Reports Admin Log out

Innes Lee

DOB: 09/12/1995

Gender: Male

Age: 25

Race: Black or African American

CCO:

Names → Contact Information → Additional Information → Physical Description → **Family Tree** → SOGIE Information → Summary

Family Tree

Family Tree by Date: 05/13/2021

Male Female

Primary Family Tree

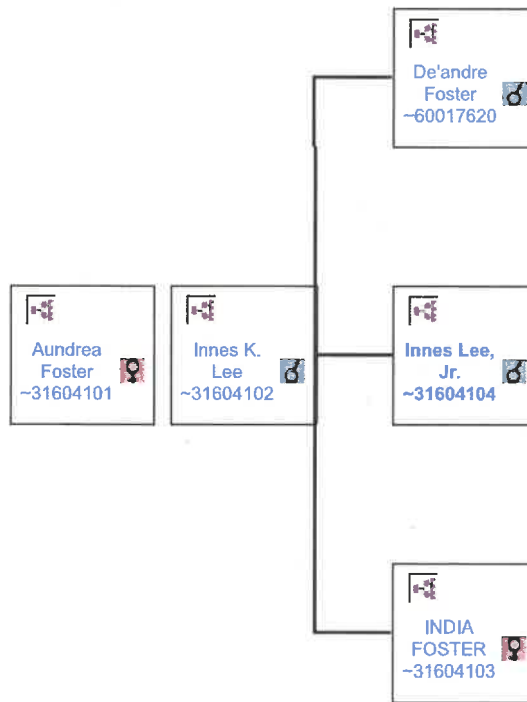

Other Family Tree

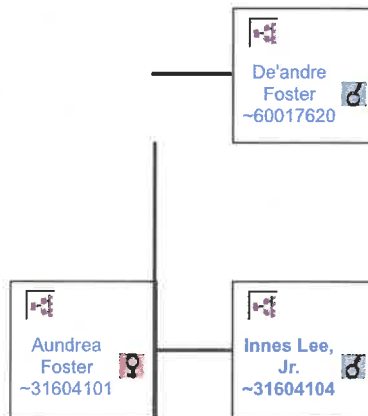

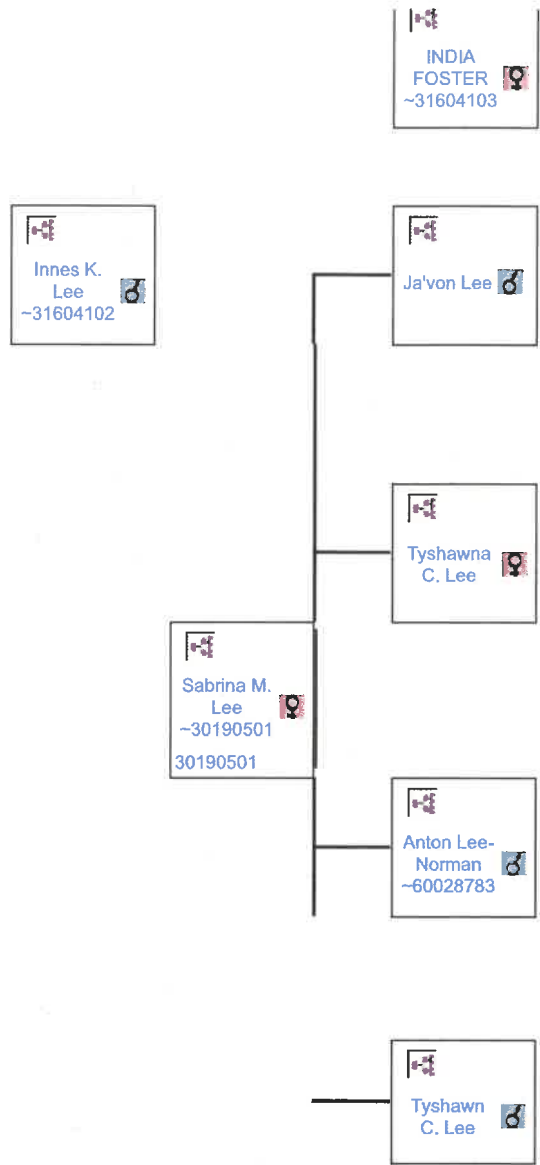

PREVIOUS / Save NEXT / Save

Cuyahoga County Sheriff's Department



General Statement and Information

For Sheriff's Department Only	
File Number	_____
Type of Ticket	_____

Describe, in detail, in your own words, an account of the events as you know them. Include the date, time and location. Include the names and addresses of other persons involved including any witnesses. Upon completion, sign and date the statement at the bottom.

I, Kali do hereby make the following statement of my own free will and accord concerning shooting which occurred on / at 4-15-20 4281 E 134th berklewood on the 15th day of April at 8 (am) (pm) on April 15th at 8am I heard a noise outside the address 4281 E 134th to hear it was P-Nut. After that P-Nut came in grabbed my/daron phone to call his ^{girl} Perfect he asked about his cousin to her and they - him & Perfect was ~~arguing~~ yelling at each other over the phone during them yelling P-Nut froze and told me and daron the cops outside daron and I panic and started to move around. Daron told P-Nut he has to go or get out on leave so I and daron ran in ~~the house~~ the house and hid there when P-Nut ran downstairs out the back door trying to hop the gate but he couldn't so he pulled out his gun drew fire and that's when the cops drew fire back altogether I heard 3 or 4 shots I seen this by looking out the window peeking and then seen P-Nut on the ground then I looked again I seen cops pumping his chest telling him to stay with us they pumped until (ems) came then I stayed crunched down me and daron scared because we don't actually know what was going on

Signature	Date and Time	Phone	DOB
Address	City and State		Social Security Number
Signature of Deputy Sheriff	Date and Time Received		

CUYAHOGA COUNTY SHERIFF'S DEPARTMENT



General Statement and Information

For Sheriff's Department Use Only

File Number _____

Type of Incident _____

Describe, in detail, in your own words, an account of the events as you know them. Include the date, time and location. Include the names and addresses of other persons involved including any witnesses. Upon completion, sign and date the statement at the bottom.

I, _____ do hereby make the following statement of my own free will and accord concerning _____ which occurred on / at _____ on the _____ day of _____ at _____ (am)(pm)

outside, probably after 30 mins after it happen I finally move from my spot I peek and peeped and was checking on daron to see if he's okay we sat there holding and hugging each other to calm ~~one another~~ ^{another} down and he held me while I told him I seen his friend dead on the ground after all the shooting me and daron stayed still and put because we didn't know what was going to happen next after hours we dozed off want to sleep but I kept waking up due to sounds outside then when I finally try to close my eyes again I hear police so I finally awake come down to a cop pointing a gun and light at me and told me to show my hands I did as told they pat me down and asked me was anyone else in there with me I lied and said no that I know of not in the room I was in so there, was scared and they asked me question and I answer them, and now im here I had nothing to do with the homicide or anything inside that home only thing mine is my phone and shoes and keys, ~~was~~ ^{an} ^{phone} other than anything else I was just there at that home because my boyfriend.

Signature 	Date and Time Apr. 15 th 20	Phone [REDACTED]	DOB 3-23-99
Address 4801 E 177 th Street G	City and State Cleveland OH	[REDACTED]	Social Security Number [REDACTED]
Signature of Deputy Sheriff #191	Date and Time Recv'd 04/15/21	1826	



Cuyahoga County Regional Forensic Science Laboratory
11001 Cedar Avenue, Cleveland, Ohio 44106
Phone: (216) 721 5610 Fax: (216) 707 3123

Notification of NIBIN Entry

CCRFSL Case Number: 2021-003401

Date: 04/27/2021

Agency Case Number: 21015453

Agency Name: Cuyahoga County Sheriff Office

Agency Address: 1215 W. 3rd Street
Cleveland, OH 44113

Requested Analysis: NIBIN Entry

Offense(s): Homicide

Evidence Item(s):

Request Number: 0005

Agency Other ID:

The following evidence was submitted to the laboratory by Watson, Michael on 4/16/2021:

18	<i>9MM SMITH & WESSON MODEL: M&P9 WITH 1 LIVE ROUND FROM CHAMBER AND 7 FROM MAGAZINE SERIAL: HMP6782</i>	1
18.4	Test fire of Item 18	

Description:

The above cartridge case(s) was entered into NIBIN and will be searched against the regional database (Zone 5, the Ohio Partition). If a lead is developed, a separate notification will be sent.

Analyst:

Justin M. Rodriguez

Justin Rodriguez
Forensic Scientist

All activities related to this case were completed between the date the evidence was received, as noted on this document, and the document's issue date. Specific activity dates are maintained in the case file for this case.

Information displayed in *Italics* is data supplied by the submitting agency or entered by CCMEIO in-take personnel.

Results in this document relate only to the item(s) tested and apply to the item(s) as received.

This document shall not be reproduced except in full, without the written approval of the Cuyahoga County Regional Forensic Science Laboratory.

CUYAHOGA COUNTY SHERIFF'S OFFICE

FILE NO. 21015453

DATE 04/15/2021

FROM Deputy Danney A. Nukta #81

TO Sheriff Viland

SUBJECT Investigation

COPIES TO Lt. Carabello; Sgt. Gregory

On April 15th, 2021 at approximately 0900hrs, Detectives from the Cuyahoga County Sheriff's Department, Detective Bureau responded to an Officer Involved, Use of Deadly Force at 4281 E. 134th St., Cleveland OH 44105. Upon arrival, Detective Danney Nukta #81 was assigned to canvass the western side of E. 134th Street. Assisting Detective Nukta was City of Cleveland Division of Police, Internal Affairs Detective Jessica Bennett #9229.

Houses canvassed in connection with the incident were the following:

133 Beachwood: - Spoke with Marcia Sudduth who stated she heard approximately 4 gun shots between 7 and 8am. Ms. Sudduth stated she does not have any video surveillance equipment on her property

4294 E134th: - Spoke with Joyelle Owens via RING doorbell camera (contact number [REDACTED]). She stated she was at home during the incident, her Ring camera (located on her front door directly across from 4281 did not capture any video footage).

4290 E134th: -Spoke with Agnes Berry; she stated she heard 4 shots. Camera was located on the front porch however she stated the camera is not functional.

4278 E134th - No answer/No camera

4270 E134th - No answer/No camera

4266 E134th: -Spoke with John Wells who stated he heard 3 shots. No camera on property

4262 E134th: No answer/appeared to be unoccupied. No cameras located

4258 E134th: - Spoke with Debra Williams who stated she was sleeping at the time and did not hear anything until the emergency vehicle sirens woke her up. No cameras on property.

4254 E134th: -Spoke with Eric Dunham who stated he was watching television at the time and heard 4 shots at approximately 8:23am. He stated he did not see anything but mention he heard faint talking in the distance around the time of the gunshots. No cameras on the property.

The canvass of the neighborhood was recorded on body camera footage and is contained within the case file.

CLASS 128

CLEVELAND POLICE RANGE RECORD

NAME PIPER, DANIEL RANK 1113 APPOINTED 1-10-11 QUALIFIED _____ ASSIGNMENT _____

JANUARY																				
FEBRUARY																				
MARCH																				
APRIL																				
MAY												8	NEW		25					
JUNE												24	LO			6	SR		25	
JULY																				
AUGUST																				
SEPTEMBER																				
OCTOBER																				
NOVEMBER																			28	P
DECEMBER																				25
QUALIFICATION	2008		2009		2010		2011		2012		2013		20							
TYPE OF COURSE																				
TOTAL																				

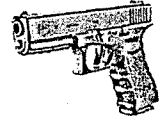

2020 STATE FIREARMS RE-QUALIFICATION

****Please print legibly****

LAST NAME: Piper BADGE: 1113 PAYROLL: _____

FIRST NAME: Daniel ASSIGNMENT: 446 / C.P./+

*****DO NOT HANDLE YOUR FIREARM UNTIL INSTRUCTED*****

MAKE: Glock MODEL: 19 SERIAL: MPD 932

HANDGUN EXAMINATION

		INITIAL TEST	1 ST RETEST	2 ND RETEST	3 RD RETEST
TOTAL HITS IN PREFERRED AREA	+1 POINT EACH				
<i>SUBTRACT THE BELOW PENALTIES FROM THE ABOVE TOTAL</i>					
HEAD OR HIP CIRCLE MISSES	-1 POINT EACH				
HIP CIRCLE MISSES	-1 POINT EACH				
HITS OFF SILHOUETTE	-1 POINT EACH				
ROUNDS FIRED OVER ALLOTTED TIME	-1 POINT EACH				
ROUNDS BEYOND 25 ALLOTTED	-1 POINT EACH				
TOTAL FINAL SCORE WAS A PASS / FAIL:		<u>25</u>			

****Please circle qualifying officers****

INSTRUCTED BY: 9993/1976/2230/2316/2176/1382/384 OTHER _____

SHOTGUN EXAMINATION

All pellets (54 total) MUST strike within the silhouette portion of the target.

NOTE: Pellets striking outside of the silhouette, THAT ARE ERRANT IN NATURE & WELL OUTSIDE OF THE ESTABLISHED SHOT GROUPING, may be excluded from scoring at the discretion of the Certified Firearms Instructor scoring the target.

Stage:	Feet:	Rounds:	Condition:	Time:	After Action:	INITIAL TEST	1 ST RETEST	2 ND RETEST	3 RD RETEST
1	10	2	3	4 sec	Scan				
2	20	2	2	3 sec	Scan / Load				
3	30	2	2	3 sec	Scan				
4	50	2	2	20 sec	Scan	N/A	N/A	N/A	N/A
TOTAL FINAL SCORE WAS A PASS / FAIL:						<u>6</u>			

****Please circle qualifying officers****

INSTRUCTED BY: 9993/1976/2230/2316/2176/1382/384 OTHER _____

DUTY AMMUNITION ISSUED FOR SERVICE MAGAZINES: ~~46~~ of ~~52~~ 50

SIGNATURE: Daniel W. Piper BADGE: 1113 DATE: 7-29-2020

15

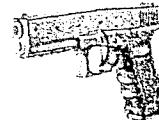

2019 STATE FIREARMS RE-QUALIFICATION

****Please print legibly****

LAST NAME: Piper BADGE: 1113 PAYROLL: 195664

FIRST NAME: David ASSIGNMENT: 44 / C.P.H.

DO NOT HANDLE YOUR FIREARM UNTIL INSTRUCTED

MAKE: Glock MODEL: 619 SERIAL: MPD932

HANDGUN EXAMINATION

		INITIAL TEST	1 ST RETEST	2 ND RETEST	3 RD RETEST
TOTAL HITS IN PREFERRED AREA	+1 POINT EACH				
SUBTRACT THE BELOW PENALTIES FROM THE ABOVE TOTAL					
HEAD OR HIP CIRCLE MISSES	-1 POINT EACH				
HIP CIRCLE MISSES	-1 POINT EACH				
HITS OFF SILHOUETTE	-1 POINT EACH				
ROUNDS FIRED OVER ALLOTTED TIME	-1 POINT EACH				
ROUNDS BEYOND 25 ALLOTTED	-1 POINT EACH				
TOTAL FINAL SCORE:		<u>24</u>			

****Please circle qualifying officers****

INSTRUCTED BY: 9993/1976/2230/2316/2176/1382/384 OTHER _____

SHOTGUN EXAMINATION

All pellets (54 total) MUST strike within the silhouette portion of the target.

NOTE: Pellets striking outside of the silhouette, THAT ARE ERRANT IN NATURE & WELL OUTSIDE OF THE ESTABLISHED SHOT GROUPING, may be excluded from scoring at the discretion of the Certified Firearms Instructor scoring the target.

Stage:	Feet:	Rounds:	Condition:	Time:	After Action:	INITIAL TEST	1 ST RETEST	2 ND RETEST	3 RD RETEST
1	10	2	3	4 sec	Scan				
2	20	2	2	3 sec	Scan / Load				
3	30	2	2	3 sec	Scan				
4	50	2	2	20 sec	Scan	N/A	N/A	N/A	N/A
TOTAL FINAL SCORE:						<u>6</u>			

****Please circle qualifying officers****

INSTRUCTED BY: 9993/1976/2230/2316/2176/1382/384 OTHER 2123

DUTY AMMUNITION ISSUED FOR SERVICE MAGAZINES: 46 or 52

SIGNATURE: Del W. Piper BADGE: 1113 DATE: 2-11-19



2018 STATE FIREARMS RE-QUALIFICATION

****Please print legibly****

LAST NAME: Piper BADGE: 1113 PAYROLL: 195664

FIRST NAME: Daniel ASSIGNMENT: 3rd / DSU

FIREARM INFORMATION

MAKE: Glock MODEL: 19 SERIAL: MPP932

HANDGUN EXAMINATION

		PRACTICE	TEST	RETEST	2ND RETEST
TOTAL HITS IN PREFERRED AREA	+1 POINT EACH				
<i>SUBTRACT THE BELOW PENALTIES FROM THE ABOVE TOTAL</i>					
HEAD OR HIP CIRCLE MISSES	-1 POINT EACH				
HIP CIRCLE MISSES	-1 POINT EACH				
HITS OFF SILHOUETTE	-1 POINT EACH				
ROUNDS FIRED OVER ALLOTTED TIME	-1 POINT EACH				
ROUNDS BEYOND 25 ALLOTTED	-1 POINT EACH				
TOTAL FINAL SCORE:		<u>25</u>	<u>25</u>		

****Please circle qualifying officers****

INSTRUCTED BY: 9993/1976/2230/2316/2176/628/1382/2526/384 OTHER _____

SHOTGUN EXAMINATION

All pellets (54 total) MUST strike within the silhouette portion of the target.									
NOTE: Pellets striking outside of the silhouette, THAT ARE ERRANT IN NATURE & WELL OUTSIDE OF THE ESTABLISHED SHOT GROUPING, may be excluded from scoring at the discretion of the Certified Firearms Instructor scoring the target.									
Stage:	Feet:	Rounds:	Condition:	Time:	After Action:	INITIAL TEST	1 ST RETEST	2 ND RETEST	3 RD RETEST
1	10	2	3	4 sec	Scan				
2	20	2	2	3 sec	Scan / Load				
3	30	2	2	3 sec	Scan				
4	50	2	2	20 sec	Scan	N/A	N/A	N/A	N/A
TOTAL FINAL SCORE:						<u>6</u>			

****Please circle qualifying officers****

INSTRUCTED BY: 9993/1976/2230/2316/2176/628/1382/2526 OTHER _____

DUTY AMMUNITION ISSUED FOR SERVICE MAGAZINES: 46 or 52

SIGNATURE: Daniel W. Piper BADGE: 1113 DATE: 3-16-18

14



2017 STATE FIREARMS RE-QUALIFICATION

****Please print legibly****

LAST NAME: Piper BADGE: 1113 PAYROLL: 195664

FIRST NAME: Daniel ASSIGNMENT: 3rd / DSU

FIREARM INFORMATION

MAKE: Glock MODEL: 19 SERIAL: MPD932

HANDGUN EXAMINATION

		INITIAL TEST	1 ST RETEST	2 ND RETEST	3 RD RETEST
TOTAL HITS IN PREFERRED AREA	+1 POINT EACH				
<i>SUBTRACT THE BELOW PENALTIES FROM THE ABOVE TOTAL</i>					
HEAD OR HIP CIRCLE MISSES	-1 POINT EACH				
HIP CIRCLE MISSES	-1 POINT EACH				
HITS OFF SILHOUETTE	-1 POINT EACH				
ROUNDS FIRED OVER ALLOTTED TIME	-1 POINT EACH				
ROUNDS BEYOND 25 ALLOTTED	-1 POINT EACH				
TOTAL FINAL SCORE:		<u>25</u>			

****Please circle qualifying officers****

INSTRUCTED BY: 9993/1214/1976/2230/2316/2176/628/1382/OTHER _____

SHOTGUN EXAMINATION

All pellets (54 total) MUST strike within the silhouette portion of the target.

NOTE: Pellets striking outside of the silhouette, THAT ARE ERRANT IN NATURE & WELL OUTSIDE OF THE ESTABLISHED SHOT GROUPING, may be excluded from scoring at the discretion of the Certified Firearms Instructor scoring the target.

Stage:	Feet:	Rounds:	Condition:	Time:	After Action:	INITIAL TEST	1 ST RETEST	2 ND RETEST	3 RD RETEST
1	10	2	3	4 sec	Scan				
2	20	2	2	3 sec	Scan / Load				
3	30	2	2	3 sec	Scan				
4	50	2	2	20 sec	Scan	N/A	N/A	N/A	N/A
TOTAL FINAL SCORE:						<u>6</u>			

****Please circle qualifying officers****

INSTRUCTED BY: 9993/1214/1976/2230/2316/2176/628/1382/OTHER _____

DUTY AMMUNITION ISSUED FOR SERVICE MAGAZINES: 46 or 52

SIGNATURE: D. W. Piper BADGE: 1113 DATE: 7-14-17



2016 STATE FIREARMS RE-QUALIFICATION

****Please print legibly****

LAST NAME: Piper BADGE: 1113 PAYROLL: 195664

FIRST NAME: Daniel ASSIGNMENT: 3rd / DSU

FIREARM INFORMATION

MAKE: Glock MODEL: 19 SERIAL: MPD932

HANDGUN EXAMINATION

		INITIAL TEST	1 ST RETEST	2 ND RETEST	3 RD RETEST
TOTAL HITS IN PREFERRED AREA	+1 POINT EACH				
SUBTRACT THE BELOW PENALTIES FROM THE ABOVE TOTAL					
HEAD OR HIP CIRCLE MISSES	-1 POINT EACH				
HIP CIRCLE MISSES	-1 POINT EACH				
HITS OFF SILHOUETTE	-1 POINT EACH				
ROUNDS FIRED OVER ALLOTTED TIME	-1 POINT EACH				
ROUNDS BEYOND 25 ALLOTTED	-1 POINT EACH				
TOTAL FINAL SCORE:		<u>25</u>			

****Please circle qualifying officers****

INSTRUCTED BY: 9993/1214/1976/2230/1806/2316/2176/OTHER _____

Sgt. Campbell Suva Nuti Merritt Blaine O'Connor Reddy

SHOTGUN EXAMINATION

All pellets (54 total) MUST strike within the silhouette portion of the target.

NOTE: Pellets striking outside of the silhouette, THAT ARE ERRANT IN NATURE & WELL OUTSIDE OF THE ESTABLISHED SHOT GROUPING, may be excluded from scoring at the discretion of the Certified Firearms Instructor scoring the target.

Stage:	Feet:	Rounds:	Condition:	Time:	After Action:	INITIAL TEST	1 ST RETEST	2 ND RETEST	3 RD RETEST
1	10	2	3	4 sec	Scan	<u>2</u>			
2	20	2	2	3 sec	Scan / Load	<u>2</u>			
3	30	2	2	3 sec	Scan	<u>2</u>			
4	50	2	2	20 sec	Scan	N/A	N/A	N/A	N/A
TOTAL FINAL SCORE:						<u>6</u>			

****Please circle qualifying officers****

INSTRUCTED BY: 9993/1214/1976/2230/1806/2316/2176/OTHER _____

Sgt. Campbell Suva Nuti Merritt Blaine O'Connor Reddy

DUTY AMMUNITION ISSUED FOR SERVICE MAGAZINES: **46 or 52**

SIGNATURE: Daniel W. Piper BADGE: 1113 DATE: 3-11-16



2015 STATE FIREARMS RE-QUALIFICATION

****Please print legibly****

LAST NAME: Piper BADGE: 1113 PAYROLL: _____

FIRST NAME: Daniel ASSIGNMENT: 3rd / DSU

FIREARM INFORMATION

MAKE: Glock MODEL: 19 SERIAL: MPP 932

HANDGUN EXAMINATION

		INITIAL TEST	1 ST RETEST	2 ND RETEST	3 RD RETEST
TOTAL HITS IN PREFERRED AREA	+1 POINT EACH				
SUBTRACT THE BELOW PENALTIES FROM THE ABOVE TOTAL					
HEAD OR HIP CIRCLE MISSES	-1 POINT EACH				
HIP CIRCLE MISSES	-1 POINT EACH				
HITS OFF SILHOUETTE	-1 POINT EACH				
ROUNDS FIRED OVER ALLOTTED TIME	-1 POINT EACH				
ROUNDS BEYOND 25 ALLOTTED	-1 POINT EACH				
TOTAL FINAL SCORE:		<u>25</u>			

****Please circle qualifying officers****

INSTRUCTED BY: 9993 1214 1623 1976 2048 1806 2316 OTHER _____

SHOTGUN EXAMINATION

All pellets (54 total) MUST strike within the silhouette portion of the target.

NOTE: Pellets striking outside of the silhouette, THAT ARE ERRANT IN NATURE & WELL OUTSIDE OF THE ESTABLISHED SHOT GROUPING, may be excluded from scoring at the discretion of the Certified Firearms Instructor scoring the target.

Stage:	Feet:	Rounds:	Condition:	Time:	After Action:	INITIAL TEST	1 ST RETEST	2 ND RETEST	3 RD RETEST
1	10	2	3	4 sec	Scan	<u>2</u>			
2	20	2	2	3 sec	Scan / Load	<u>2</u>			
3	30	2	2	3 sec	Scan	<u>2</u>			
4	50	2	2	20 sec	Scan	N/A	N/A	N/A	N/A
TOTAL FINAL SCORE:						<u>6</u>			

****Please circle qualifying officers****

INSTRUCTED BY: 9993 1214 1623 1976 2048 1806 2316 OTHER _____

DUTY AMMUNITION ISSUED FOR SERVICE MAGAZINES: 46 or 52

SIGNATURE: Det W. P. T. BADGE: 1113 DATE: 3-10-15

Piper, Daniel #1113

CLEVELAND POLICE RANGE RECORD

PAYROLL: _____

195664

1/10/2011

APPOINTED _____ QUALIFIED _____ ASSIGNMENT _____

JANUARY																									
FEBRUARY				11	P	25	S	6					11	P	25	S	6								
MARCH	10	P	25	S	6							16	P	25	S	6									
APRIL																									
MAY																									
JUNE																									
JULY									14	P	25	S	6								29	P	25	S	6
AUGUST																									
SEPTEMBER																									
OCTOBER																									
NOVEMBER																									
DECEMBER																									
QUALIFICATION	2015			2016			2017			2018			2019			2020			2021						
TYPE OF COURSE																									
TOTAL																									

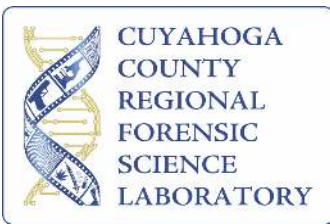

Cuyahoga County Regional Forensic Science Laboratory
11001 Cedar Avenue, Cleveland, Ohio 44106
Phone: (216) 721 5610 Fax: (216) 707 3123

Notification of Firearm Inspection

CCRFSL Case Number: 2021-003401
Agency Case Number: 21015453
Agency Name: Cuyahoga County Sheriff Office
Agency Address: 1215 W. 3rd Street
Cleveland, OH 44113
Requested Analysis: Test Fire
Offense(s): Homicide
Lab Case #: 2021-003401
Request Number: 0004

Date: 04/27/2021

The following evidence was submitted to the laboratory by Watson, Michael on 4/16/2021:

Evidence Item(s): 018 Agency Item No: 1

Description: *9MM SMITH & WESSON MODEL: M&P9 WITH 1 LIVE ROUND FROM CHAMBER AND 7 FROM MAGAZINE SERIAL: HMP6782*

Package Type:	Box	Package Sealed:	Yes
Type:	Pistol	Action:	Semi-Automatic
Make:	Smith & Wesson	Model:	M&P 9 Shield
Caliber:	9 mm	Serial Number:	HMP6782
Country of Origin:	USA	Importer:	NA
Magazine Capacity:	8 round	Firearm Capacity:	9 rounds
Submitted Ammunition:	Eight (8) CBC 9 mm Luger caliber cartridges		
Test Information:	Submitted magazine and six (6) rounds laboratory stock ammunition used for test fire.		
Operating Condition:	Firearm was test fired without malfunction. (Operable)		
Test Samples:	Retained		
Item Status:	Retained		
NIBIN Case:	Yes		
Remarks:			

The following evidence was submitted to the laboratory by Watson, Michael on 4/16/2021:

Evidence Item(s): 019 Agency Item No: 010

Description: *One black GLOCK 19 with streamlight TLR-1 flashlight SERIAL:MPD932*

Package Type:	Box	Package Sealed:	Yes
Type:	Pistol	Action:	Semi-Automatic
Make:	Glock	Model:	19
Caliber:	9 mm	Serial Number:	MDP932
Country of Origin:	Austria	Importer:	Glock Inc.
Magazine Capacity:	No Magazine	Firearm Capacity:	1 round
Submitted Ammunition:	No ammunition		
Test Information:	Firearms section magazine and six(6) rounds laboratory stock ammunition used for test fire.		
Operating Condition:	Firearm was test fired without malfunction. (Operable)		
Test Samples:	Retained		
Item Status:	Retained		
NIBIN Case:	No		
Remarks:			



Cuyahoga County Regional Forensic Science Laboratory
11001 Cedar Avenue, Cleveland, Ohio 44106
Phone: (216) 721 5610 Fax: (216) 707 3123

Notification of Firearm Inspection

Lab Case #: 2021-003401

Agency Case #: 21015453

Analyst:

James Kooser

Witness: Koeth, Kristen

All activities related to this case were completed between the date the evidence was received, as noted on this document, and the document's issue date. Specific activity dates are maintained in the case file for this case.

Information displayed in *Italics* is data supplied by the submitting agency or entered by CCMEIO in-take personnel.

Results in this document relate only to the item(s) tested and apply to the item(s) as received.

This document shall not be reproduced except in full, without the written approval of the Cuyahoga County Regional Forensic Science Laboratory.



**Cuyahoga County
Medical Examiner's Office**
11001 Cedar Avenue, Cleveland, Ohio 44106
MEDICAL EXAMINER'S VERDICT

Thomas P. Gilson, M.D.
Medical Examiner

**THE STATE OF OHIO,
SS.
CUYAHOGA COUNTY**

CASE NUMBER: IN2021-00707

Be it Remembered, That on the 15th day of April, 2021 information was given to me, **Thomas P. Gilson, M.D.**, Medical Examiner of said County, that the dead body of a man supposed to have come to his death as the result of criminal or other violent means, or by casualty, or by suicide, or suddenly when in apparent health, or in any suspicious or unusual manner, (Sec. 313-11, 313-12 R.C. Ohio) had been found on ground, in rear yard, at 4281 East 134th Street in Cleveland of Cuyahoga County, on the 15th day of April, 2021.

I viewed or caused to be viewed the said body at the Medical Examiner's Office. After the viewing and making inquiry into the circumstances that caused the death of the said person, I obtained further information, to-wit: (CCSO #21-015453). I also carefully examined or caused to be examined the said dead body at 7:55AM on the 16th day of April, 2021 and I find as follows: to wit:

I, **Thomas P. Gilson, M.D.**, Medical Examiner of said county, having diligently inquired, do true presentment make in what manner Innes Kirk Lee Jr., whose body was at the Medical Examiner's Office on the 16th day of April, 2021 came to his death. The said Innes Kirk Lee Jr. was never married, 25 years of age, a resident of Cleveland, Cuyahoga County, Ohio, and a native of Cleveland, Ohio; was of the Black race, and had brown eyes, black hair, black beard, black mustache, was 65 inches in height, and weighed 186 pounds.

Upon full inquiry based on all the known facts, I find that the said Innes Kirk Lee Jr. came to his death officially on the 15th day of April, 2021 on ground, in rear yard, at 4281 East 134th Street and was officially pronounced dead at 8:36 A.M., by Dr. Collins. There is history that on the morning of April 15th, 2021, Cleveland Police was patrolling in the area of the aforementioned location. At about 8:24 A.M., this same date, a male identified as, the said Innes Kirk Lee Jr., 1660 East 93rd Street, was observed by officers, fleeing the scene, and a pursuit ensued. When in the rear yard at the aforementioned East 134th Street address, weapons were produced, and this man was shot during legal intervention, and collapsed to the ground. The Cuyahoga County Sheriff's Office and Cleveland Paramedics were called and on arrival, the said Innes Kirk Lee Jr. was found to have expired and was pronounced dead at the aforementioned time and date. The County Medical Examiner's Office was notified and Esposito Mortuary Services was dispatched. This man was then transported to the Medical Examiner's Office where an autopsy was performed. That death in this case was the end result of multiple gunshot wounds of head, thorax, left arm, and right upper leg with visceral, vascular, and skeletal injuries, and was homicidal in nature.

Cause of Death: Multiple gunshot wounds of head, thorax, left arm, and right upper leg with visceral, vascular, and skeletal injuries.
HOMICIDE.

Innes Kirk Lee Jr.
(Name of Deceased)

Cuyahoga County Medical Examiner

,M.D.



Cuyahoga County Regional Forensic Science Laboratory
11001 Cedar Avenue, Cleveland, OH 44106



TOXICOLOGY LABORATORY FINAL REPORT

Report Date: 06/09/2021
 CCRFSL Case: 2021-003401
 Agency Case: IN2021-00707
 Agency Representative: Joseph Felo

Individual: Lee Jr, Innes Kirk
 Submitting Agency: Cuyahoga County Medical Examiners Office
 Address: 11001 Cedar Avenue, Cleveland, OH 44106

Specimen(s) Received

Lab Item #	Description
030	Femoral Blood 1
031	Urine 1
032	Bile 1
033	Vitreous Humor 1
034	Vitreous Humor 2
035	Gastric Contents 1
036	Long-term Storage 1
037	Long-term Storage 2
038	Long-term Storage 3
039	Liver 1
040	Brain 1
041	Blood 1 (Right Thorax)

Item: 030: Femoral Blood 1		
Drug Group/Class	Result	Quantitation
Basic Drugs by GC/MS		
Cotinine		
Cocaine/Metabolites Confirmation by GC/MS		
Cocaine	Positive	<15 ng/mL
Cocaethylene	Positive	16 ± 2 ng/mL
Benzoylcegonine	Positive	211 ± 32 ng/mL
ELISA		
SEE CONFIRMATION		
Volatiles Screening and Confirmation by GC/FID		
Ethanol	Positive	0.086 ± 0.007 g/dL

Item: 031: Urine 1		
Drug Group/Class	Result	Quantitation
Basic Drugs by GC/MS		
Nicotine	Positive	
Anhydroecgonine methyl ester	Positive	
Ecgonine methyl ester	Positive	
Cotinine	Positive	
Doxylamine	Positive	
Dextromethorphan	Positive	
Cocaine	Positive	



**Cuyahoga County Regional Forensic Science Laboratory
11001 Cedar Avenue, Cleveland, OH 44106**



TOXICOLOGY LABORATORY FINAL REPORT

Report Date: 06/09/2021
 CCRFSL Case: 2021-003401
 Agency Case: IN2021-00707
 Agency Representative: Joseph Felo

Individual: Lee Jr, Innes Kirk
 Submitting Agency: Cuyahoga County Medical Examiners Office
 Address: 11001 Cedar Avenue, Cleveland, OH 44106

Cocaethylene Benzoyllecgonine	Positive Positive	
----------------------------------	----------------------	--

Item: 033: Vitreous Humor 1		
Drug Group/Class Volatiles Screening and Confirmation by GC/FID Ethanol	Result Positive	Quantitation 0.118 ± 0.009 g/dL

COMMENTS:

All laboratory activities related to this case were completed between the date the evidence was received, as noted in this report, and the report's issue date. Specific activity dates are maintained in the case file for this case.

The result(s) in this report relate only to the items tested. Other specimens received will be held with the case (not tested).

'None Detected/Not Performed' in ELISA testing indicates that there were no positive signals in the ELISA (confirmation testing not performed).

Where quantitative results have been provided, method uncertainty is determined at a CL of 95.45%. 'Mass Spectrum Match Only' denotes the finding has not been confirmed against the retention time of a reference standard.

Specimens submitted for this case will be held for one year prior to disposal. Please notify Toxicology if the specimens are to be held for a longer period of time (216 698 5638).

This report shall not be reproduced, except in full, and with written approval of the Cuyahoga County Regional Forensic Science Laboratory.

Chief Toxicologist 
 Luigino Apollonio Ph.D.



Cuyahoga County Regional Forensic Science Laboratory
11001 Cedar Avenue, Cleveland, OH 44106



Page 3 of 4

TOXICOLOGY LABORATORY FINAL REPORT

Report Date: 06/09/2021
CCRFSL Case: 2021-003401
Agency Case: IN2021-00707
Agency Representative: Joseph Felo

Individual: Lee Jr, Innes Kirk
Submitting Agency: Cuyahoga County Medical Examiners Office
Address: 11001 Cedar Avenue, Cleveland, OH 44106

Analysis Summary

VOLATILES SCREENING AND CONFIRMATION by GC/FID: Ethanol, Methanol, Acetone, Isopropanol. **VOLATILES by GC/MS:** includes (but not limited to) Acetaldehyde, Acetone, Chloroform, Dichloromethane, Ethanol, Ethyl Acetate, Isopropanol, Methanol, Toluene

ACIDIC/NEUTRAL DRUGS by GC/MS and GC/FID: Butalbital, Caffeine, Carbamazepine, Carisoprodol, Ibuprofen, Levetiracetam, Meprobamate, Metaxalone, Pentobarbital, Phenobarbital, Phenytoin

CARBON MONOXIDE by CO-Oximetry: Carbon Monoxide (Carboxyhemoglobin)

GLYCOLS CONFIRMATION by GC/MS: Ethylene Glycol, Propylene Glycol

GABAPENTIN/PREGABALIN CONFIRMATION by LC-MS/MS: Gabapentin, Pregabalin

ELISA (Enzyme-Linked Immunosorbent Assay) SCREEN: Amphetamine (Target = d-Amphetamine); Barbiturates (Target = Pentobarbital); Benzodiazepines (Target = Alprazolam); Cannabinoids (Target = 11-nor- Δ -9-THC-COOH (marijuana metabolite)); Carisoprodol (Target = Carisoprodol); Cocaine Metabolite (Target = Benzoyllecgonine); Fentanyl (Target = Fentanyl); Methamphetamine (Target = d-Methamphetamine); Oxycodone (Target = Oxycodone); Phencyclidine (Target = Phencyclidine); Tricyclic Antidepressants (Target = Nortriptyline); Methadone (Target = Methadone); Opiates (Target = Morphine); Zolpidem (Target = Zolpidem); Buprenorphine (Target = Buprenorphine)

BASIC DRUGS by GC/MS (screening and confirmation): includes common antidepressants, opioids/narcotic analgesics, CNS stimulants, antipsychotics, antiarrhythmics, dissociative anesthetics, antihistamines, hypnotosedatives/anxiolytics, muscle relaxants, cathinones, and other agents

ACETAMINOPHEN and SALICYLATES SCREEN by Colorimetry (Qualitative): Acetaminophen, Salicylates

PHENCYCLIDINE (PCP) CONFIRMATION by GC/MS: Phencyclidine

CLINICAL CHEMISTRIES: Sodium, Potassium, Chloride, Glucose, Urea (as VUN), Creatinine, Magnesium, Calcium, Lactate

COCAINE AND METABOLITES CONFIRMATION by GC/MS: Benzoyllecgonine, Cocaine, Cocaethylene

CANNABINOIDS CONFIRMATION by LC-MS/MS: Δ 9-THC, 11-OH- Δ 9-THC (marijuana metabolite), 11-nor- Δ 9-THC-COOH (marijuana metabolite).
CANNABINOIDS CONFIRMATION by GC/MS: TOTAL 11-nor- Δ 9-THC-COOH (marijuana metabolite)

OPIOIDS CONFIRMATION by GC/MS: Morphine, 6-Acetylmorphine (heroin metabolite), Codeine, Hydrocodone, Dihydrocodeine, Hydromorphone, Oxycodone, Oxycodone

BENZODIAZEPINES CONFIRMATION by LC-MS/MS: (\pm)-Zopiclone, 2-Hydroxyethylflurazepam, 3-Hydroxyflunitrazepam, 4-Hydroxyalprazolam, 7-Aminoclonazepam, 7-Aminoflunitrazepam, Alprazolam, Bromazepam, Clobazam, Clonazepam, Clonazepam, Delorazepam, Deschloroetizolam, Diazepam, Diclazepam, Estazolam, Etizolam, Flualprazolam, Flubromazepam, Flubromazepam, Flunitrazepam, Flunitrazepam, Flurazepam, Lorazepam, Lorazepam, Lorazepam, Methylenedioxymethamphetamine, Midazolam, N-Desalkylflurazepam, N-Desmethylclobazam, N-Desmethylflunitrazepam, Nitrazepam, Nitrazepam, Nordiazepam, Oxazepam, Phenazepam, Temazepam, Triazolam, Zaleplon, Zolpidem, α -Hydroxyalprazolam, α -Hydroxymidazolam and α -Hydroxytriazolam

AMINES CONFIRMATION by LC-MS/MS analysis: (\pm)-Amphetamine, beta-Phenethylamine, 3,4-Methylenedioxy-N-ethylamphetamine (MDEA), (\pm)-Methamphetamine, Methylenedioxymethamphetamine (MDA), Methylenedioxymethamphetamine (MDMA), Phentermine, Ephedrine/Pseudoephedrine

FENTANYL and ANALOGUES CONFIRMATION by LC-MS/MS: N-Methyl norfentanyl, Norfentanyl, Norcarfentanil, AP-238, 2MAP-237, Methoxyacetyl fentanyl, Acetyl fentanyl, Beta-hydroxy fentanyl, Benzyl fentanyl, THF fentanyl, 4-ANPP, p-Methoxyacetyl fentanyl, Acryl fentanyl, Alfentanil, Fentanyl, *para*-Fluoro acryl fentanyl, *para*-Fluoro fentanyl, Cyclopropyl fentanyl, 2-Furanyl fentanyl, Fentanyl carbamate, (\pm)-*trans*-3-Methylfentanyl, Crotonyl fentanyl, Carfentanil, (\pm)-*cis*-3-Methylfentanyl, Butyryl fentanyl, *para*-Fluoroisobutyryl fentanyl (FIBF), Sufentanil, Phenyl fentanyl, Cyclopentenyl fentanyl, *para*-Fluorofuranyl fentanyl, Valeryl fentanyl, Isobutyryl fentanyl, Thiophene fentanyl, Isovaleryl fentanyl; plus Metonitazene, Borphine, Isotonitazene, Protonitazene



**Cuyahoga County Regional Forensic Science Laboratory
11001 Cedar Avenue, Cleveland, OH 44106**



Page 4 of 4

TOXICOLOGY LABORATORY FINAL REPORT

Report Date: 06/09/2021
CCRFSL Case: 2021-003401
Agency Case: IN2021-00707
Agency Representative: Joseph Felo

Individual: Lee Jr, Innes Kirk
Submitting Agency: Cuyahoga County Medical Examiners Office
Address: 11001 Cedar Avenue, Cleveland, OH 44106

SENT TO REFERENCE LABS: Synthetic Cannabinoids, Cathinones, Cyanide, GHB, LSD, Psilocin, Valproic Acid, heavy metals (Antimony, Arsenic, Lead, Barium, Cadmium, Bismuth, Mercury, Selenium), or any other compounds not listed above

ABBREVIATIONS: UNS = Specimen unsuitable for testing; QNS = Quantity insufficient for analysis; < = less than; > = greater than; LRL= Lower reporting limit; C.L. = Confidence Level
UNITS FOR VOLATILES: 100 mg/dL = 0.100 g/dL = 0.100 g/%. **UNITS:** 1 mg/L = 1000 µg/L = 1000 ng/mL



**Cuyahoga County
Medical Examiner's Office**
11001 Cedar Avenue, Cleveland, Ohio 44106
REPORT OF AUTOPSY

Thomas P. Gilson, M.D.
Medical Examiner

**THE STATE OF OHIO,
SS.
CUYAHOGA COUNTY**

CASE NUMBER: IN2021-00707

**REPORT OF AUTOPSY OF: Innes Kirk Lee Jr.
ADDRESS: 1660 East 93rd Street, Cleveland, Ohio**

I, **Thomas P. Gilson, M.D.**, Medical Examiner of Cuyahoga County, Ohio, Certify that on the **16th** day of **April, 2021** at **9:10 AM** in accordance with Section 313.13 of the Revised Code, of the State of Ohio, an autopsy was performed on the body of **Innes Kirk Lee Jr.**.

The following is the report of autopsy to the best of my knowledge and belief: This person was a **male, never married**, aged **25 years**, of the **Black** race; had **brown eyes, black hair, good teeth**, was **65 inches** in height, weighing **186 pounds**; a native of **Cleveland, Ohio**.

ANATOMIC DIAGNOSES:

- I. Gunshot wound of head
 - A. Lacerations of skin and subcutaneous soft tissues of the upper lip and left zygomatic face
 - B. Abrasion of margin of left nostril
 - C. Lacerations of oral mucosa
 - D. Fractures of maxilla
 - E. Fracture avulsions of five maxillary teeth

- II. Gunshot wound of thorax
 - A. Lacerations of skin and subcutaneous soft tissues of the left thorax, pericardial sac, heart, both lungs, pulmonary artery, ascending aorta, right pulmonary vein, and right sixth intercostal soft tissues
 - B. Subcutaneous hematomas of left lateral and right posterior thorax
 - C. Fractures of left third and right seventh ribs
 - D. Hemopericardium, 50 ml
 - E. Bilateral hemothoraces: right = 200 ml, left = 600 ml

- III. Gunshot wound of left arm
 - A. Lacerations of skin and subcutaneous soft tissues of the distal left upper arm
 - B. Fracture of distal left humerus

- IV. Gunshot wound of posterior right upper leg with lacerations of skin and subcutaneous soft tissues

- V. Obesity
 - A. Body weight = 186 pounds
 - B. Body length = 65 inches
 - C. Body mass index = 30.9 kg/m²

- VI. Electrocardiogram electrode pads

Cause of Death: Multiple gunshot wounds of head, thorax, left arm, and right upper leg with visceral, vascular, and skeletal injuries.
HOMICIDE.

Joseph A. Felo, D.O.
(Name of Pathologist)

Pathologist Signature

Innes Kirk Lee Jr.
(Name of Deceased)

Cuyahoga County Medical Examiner, M.D.

GROSS ANATOMIC DESCRIPTION

As initially viewed on the scene, the body is that of an adult black male lying supine on the grass of the back yard of a residential home. The body is underneath a canopy erected by the Cuyahoga County Sheriff's Office. The body is clothed with a cut sweatshirt, cut shirt, cut pants, undershorts, socks, and shoes. His arms are handcuffed behind his back and the handcuffs were removed at the scene. Lacerations consistent with gunshot wounds are on the left face, beneath the right nostril, on the left anterior thorax, on the lateral left elbow, and two in the posterior right upper leg. The body is cool with mild rigor mortis and dorsal lividity. Prior to autopsy, and at the Cuyahoga County Medical Examiner's Office, the body is undressed by a member of the Trace Evidence Department.

EXTERNAL EXAMINATION: The nude body is that of a normally-developed and adequately nourished obese black male, whose appearance is consistent with the reported age of 25 years. The body weighs 186 pounds and is 65 inches in length.

The body is in full rigor mortis. Lividity is dorsal and unfixed. The skin temperature is cold.

The scalp hair is short, black, curly, and has a normal distribution. A black moustache and goatee are present, and the remainder of the is clean-shaven. The conjunctivae are clear, the corneas are clear, and the irides are brown. The pupils are unremarkable. Both earlobes have single pierced holes, and the ears are otherwise unremarkable. The nose and mouth show no chronic abnormalities. The teeth are natural and in good condition. The neck has an obese configuration, and there are no palpable masses. The thorax is symmetrical and has an obese configuration. The breasts are of normal adult male configuration, and there are no palpable masses. The abdomen is rounded and soft, and longitudinal striae are on the anterior and both lateral surfaces of the abdomen. The external genitalia are of normal adult male uncircumcised conformation, and there are no external lesions. The extremities appear normal, and the joints are not deformed. All digits are present. The skin is of normal pliability and texture. An approximate 6" long and ¼" wide faint, non-hemorrhagic furrow is around the distal left lower arm with an approximate 2" sparing of the volar surface. Focal areas of dark brown and red-brown granulation tissues are on the anterior proximal right lower leg, anteromedial proximal left lower leg, and posterior mid-section of the left lower leg in 4 ½" x ¼", ½" x ¼", and 1" x ⅛" areas, respectively.

SCARS AND IDENTIFYING MARKS:

1. A 7" x 2" black tattoo of "NFMS" is on the anterior and both lateral surfaces of the neck.
2. A 10" x 9" black tattoo of letters, clouds, two hands, and three stacks of paper money is on the anterior thorax.
3. An 8" x 8" black tattoo of a ribbon with "I'm Nothing Without my Gun", a ribbon with "But Together We Kill Shit" and multiple shapes resembling bullet shell casings and placards is on the right lateral thorax and right lateral abdomen.
4. Confluent black tattoos of a hooded head, flower, letters, clouds, buildings, skull, and bone is around the circumference of the right arm in a 21" length.
5. A 1 ¼" x ½" oval scar is on the posterior proximal left upper arm.
6. Two 2" linear scars are on the posterior proximal left upper arm.
7. A ¾" linear scar is on the posterior distal left upper arm.
8. A 6 ½" x 6" black tattoo of a map of streets, numbers, and letters is on the medial left upper arm.
9. A 7 ½" x 6" black tattoo of "MONEY MAKING NUT", two dollar signs, and "We All Blessed" is on the dorsal, radial, and volar left lower arm.
10. A ⅞" x ⅛" oval scar is on the dorsal left hand.
11. Five oval and irregular scars, each less than 1 ½" in greatest dimension, are on the anterior and medial right upper leg.

EXTERNAL AND INTERNAL EVIDENCE OF RECENT THERAPY:

1. Single electrocardiogram electrode pads are taped to the skin of the left anterior upper thorax and each anterior side of the lower abdomen.

EXTERNAL AND INTERNAL EVIDENCE OF RECENT INJURY:

1. Perforating gunshot wound of face:
 - I. Entrance: A $\frac{3}{8}$ " x $\frac{1}{4}$ " oval laceration is in the skin of the right upper lip, and is centered on a point 5" below the scalp vertex and $\frac{5}{8}$ " right of the facial midline. A $\frac{1}{8}$ " wide brown-red abrasion is at the lateral margin of the oval laceration and three superficial lacerations, each less than $\frac{1}{8}$ " in length, are at the medial margin of the oval laceration. No black powder or stipple wounds are deposited on the skin adjacent to the abraded laceration and no black powder is visible within the subcutaneous soft tissues beneath the abraded laceration.
 - II. Path of projectile: The bullet perforates the skin and subcutaneous soft tissues of the upper lip and perforates the medial maxilla.
 - III. Injuries associated with bullet path:
 - a. A longitudinal laceration is in the left paramedian upper lip skin and multiple transverse lacerations are in the left upper lip skin in a $1\frac{3}{8}$ " x $\frac{5}{8}$ " area.
 - b. A $\frac{1}{8}$ " x $\frac{1}{16}$ " brown-pink abrasion is at the anterior margin of the left nostril.
 - c. An approximate 2" x 1" mucosal laceration is in the left upper lip labial and gingival mucosa.
 - d. Multiple superficial lacerations, each less than $\frac{1}{4}$ " in greatest dimension, are in the lower lip mucosa.
 - e. Fractures are in the maxilla.
 - f. The four maxillary incisors and the left maxillary canine teeth are fractured and avulsed from their sockets.
 - IV. Exit: A 1" x $\frac{5}{8}$ " irregular laceration is in the skin of the left zygomatic face, and is centered on a point $5\frac{1}{2}$ " below the scalp vertex and $2\frac{1}{4}$ " left of the facial midline.
 - V. Course and direction: Front to back, right to left, and downward.
2. Penetrating gunshot wound of thorax:
 - I. Entrance: A $\frac{3}{8}$ " x $\frac{5}{16}$ " oval laceration is in the skin of the anterior left lateral thorax, and is centered on a point 5 1" above the sole of the right foot and 6" left of the anterior thoracic midline. The oval laceration has a dark brown concentric abrasion that is $\frac{1}{8}$ " wide at its medial margin and $\frac{1}{16}$ " wide around the remainder of the margins. No black powder or stipple wounds are deposited on the skin adjacent to the abraded laceration, and no black powder is visible within the subcutaneous soft tissues beneath the abraded laceration.
 - II. Path of projectile: The bullet sequentially perforates the subcutaneous soft tissues of the left anterior thorax, the anterior left 3rd rib, the upper lobe of the left lung, the left pericardial sac, the heart and adjacent pulmonary artery and ascending aorta, the right pulmonary vein, the lower lobe of the right lung, the posterior right 6th intercostal soft tissues, and penetrates the subcutaneous soft tissues of the posterior right thorax.
 - III. Injuries associated with bullet path:
 - a. Dark red hematomas are in the left lateral and right posterior thoracic subcutaneous soft tissues.
 - b. A transverse fracture is through the anterior left 3rd rib.
 - c. An approximate 2" hemorrhagic laceration is through the medial edge of the upper lobe of the left lung.
 - d. A $\frac{3}{4}$ " diameter laceration is through the left pericardial sac.
 - e. Extensive lacerations are in the anterior left atrium, the base of the left ventricle and interventricular septum, the atrial septum, the pulmonic and aortic valves, the pulmonary artery trunk and ascending aorta, and the left main coronary artery.
 - f. An approximate 1" laceration is through the right pulmonary vein and adjacent bronchus to the right lower lobe with a cylindrical hemorrhagic laceration that extends through the lower lobe of the right lung.
 - g. A hemorrhagic laceration is through the posterior right 6th intercostal soft tissues with an approximate 1" x $\frac{1}{8}$ " slightly

- concave fracture of the superior margin of the adjacent right 7th rib.
- h. Liquid blood is in the right pleural cavity, left pleural cavity, and pericardial sac in volumes measured 200 ml, 600 ml, and 50 ml, respectively.
- IV. Recovery of projectile: A copper jacketed bullet with grey metal core is recovered from the posterior right thoracic subcutaneous soft tissues on a point centered 50" above the sole of the right foot, 5" right of the spinal midline, and 1" beneath the surface of the skin. The jacket has six folded back petals and longitudinal black striations around its circumference. The bullet is $\frac{3}{8}$ " long with a $\frac{5}{16}$ " diameter jacketed base and a $\frac{5}{8}$ " diameter grey metal nose. The bullet is photographed and is submitted to the Cuyahoga County Regional Forensic Science Laboratories following the autopsy.
- V. Course and direction: Left to right, front to back, and downward.
3. Penetrating gunshot wound of left arm:
- I. Entrance: A $\frac{1}{8}$ " x $\frac{3}{8}$ " oval laceration is in the skin of the lateral left elbow, and with the left arm in neutral anatomic position, is centered on a point 47" above the sole of the right foot. The oval laceration is surrounded by a brown concentric abraded margin that is less than $\frac{1}{16}$ " wide. No black powder or stipple wounds are deposited on the skin adjacent to the abraded laceration, and no black powder is visible within the subcutaneous soft tissues beneath the abraded laceration.
- II. Path of projectile: The bullet perforates the distal left humerus and penetrates the subcutaneous soft tissues of the distal left upper arm without lacerating any of the major blood vessels of the left upper arm.
- III. Injury associated with bullet path:
- a. A comminuted fracture is in the distal shaft of the left humerus.
- IV. Recovery of projectile: A 1" x $\frac{3}{4}$ " x $\frac{5}{8}$ " irregular, copper jacketed bullet with grey metal core is recovered from the medial distal muscles of the left upper arm, on a point approximately 50" above the sole of the right foot with the left arm in a neutral anatomic position. Linear black striations are on the jacket and the jacketed base of the bullet has a $\frac{5}{16}$ " diameter. The bullet is photographed and is submitted to the Cuyahoga County Regional Forensic Science Laboratories following the autopsy.
- V. Course and direction: Left to right, front to back, and upward with the left arm in neutral anatomic position.
4. Perforating gunshot wound of distal posterior right upper leg:
- I. Entrance: A $\frac{1}{2}$ " diameter circular laceration is in the skin of the posterior and medial distal right upper leg, and is centered on a point 22" above the sole of the right foot and $1\frac{1}{4}$ " left of the posterior midline of the right upper leg. A $\frac{1}{4}$ " wide brown-pink abrasion is at the left lateral margin of the circular laceration, and multiple superficial lacerations are at the right lateral margin in a $\frac{3}{4}$ " x $\frac{1}{4}$ " area. No black powder or stipple wounds are deposited on the skin adjacent to the abraded laceration, and no black powder is visible within the subcutaneous soft tissues beneath the abraded laceration.
- II. Path of projectile: The bullet perforates the subcutaneous soft tissues of the posterior distal right upper leg without lacerating the muscles of the posterior right upper leg.
- III. Exit: A $1\frac{1}{4}$ " x 1" irregular laceration is in the skin of the posterior and lateral distal right upper leg, and is centered on a point $22\frac{1}{2}$ " above the sole of the right foot and $\frac{3}{4}$ " right of the posterior midline of the right upper leg.
- IV. Course and direction: Left to right and upward with no anterior or posterior deviation.

The above wounds are numbered by convention from the top downward, and the numbering is not intended to imply the sequence in which the wounds may have been sustained. The above wounds and injuries, once having been described, will not be referred to below. The remainder of the external examination of the head, neck, trunk, and extremities is unremarkable.

INTERNAL EXAMINATION: The body is opened by means of the usual "Y" and biparietal incisions. There is a diffuse increase of subcutaneous adipose tissues with the anterior abdominal wall having a 2 ½" maximal thickness. The viscera of the thoracic and abdominal cavities occupy their normal sites. The serosal surfaces are smooth and glistening. No fluid is present within the abdominal cavity. There are no abnormal masses present. The diaphragmatic leaves are normally situated. The margins of the liver and spleen are in proper relationship to their costal margins. The weights of the organs are as follows and, unless specified below, show no additional evidence of congenital or acquired disease.

Heart - 310 grams
Right lung - 250 grams
Left lung - 230 grams
Spleen - 100 grams
Liver - 960 grams
Right kidney - 120 grams
Left kidney - 100 grams
Brain - 1090 grams

NECK: The neck organs are excised en bloc and examined separately. The surface of the tongue and serial cross sections through the tongue show no gross abnormalities. The larynx and trachea have a normal caliber and are free of obstruction. The laryngeal and tracheal mucosa is soft and tan-pink. The paravertebral musculature is unremarkable. The cervical spine, hyoid bone, and tracheal cartilage are intact.

CARDIOVASCULAR:

Heart: The heart is normal in configuration. The coronary arteries have a normal anatomic distribution, and multiple cross sections show no narrowing of lumina and no evidence of thrombosis. The epicardium is smooth and glistening. There is a normal amount of epicardial fat and its distribution is normal. The great vessels enter and leave the heart in a normal manner. The cardiac chambers have a normal configuration. The septa are intact, and there are no congenital abnormalities. The myocardium is of normal consistency and appearance. The left and right ventricles are 1.4 cm and 0.3 cm thick, respectively. The heart valves are thin, pliable, and delicate, and are free of deformity. Valve circumferences are as follows: tricuspid valve = 10.5 cm, pulmonic valve = 6.0 cm, mitral valve = 7.5 cm, and aortic valve = 5 cm.

Aorta and its major branches: The aorta and its principal branches are patent throughout. There are no thrombi, areas of erosion, or zones of narrowing present.

Venae cavae and their major tributaries: The superior and inferior venae cavae and their major tributaries are patent throughout. No areas of extrinsic or intrinsic stenosis are present.

RESPIRATORY: The major bronchi have a normal caliber and are free of obstruction. The right and left lungs have a normal lobar configuration. The visceral pleura is smooth and glistening and mottled moderately with black streaks. There are no subpleural emphysematous bullae. The pulmonary arteries are free of emboli and thrombi. The lungs are crepitant throughout. The parenchyma is unremarkable.

RETICULOENDOTHELIAL: The spleen has a normal configuration. The capsule is blue-grey and smooth, without areas of thickening. On section, the splenic pulp is of normal consistency and appearance. No abnormal lymph nodes are encountered.

DIGESTIVE: The esophagus is free of lesions. The stomach has a normal configuration. The serosa is smooth and glistening. The wall is of normal thickness and the mucosa is thrown into rugal folds. There are no areas of ulceration. The stomach contains approximately 70 ml of light brown liquid. The duodenum is free of ulceration and other intrinsic lesions. The remainder of the small bowel, the colon, and the rectum are normal in appearance. The appendix is present and is unremarkable.

HEPATOBIILIARY:

Liver: The capsule is smooth and glistening. The liver configuration is normal. Multiple cross sections through the liver reveal a normal lobular pattern.

Gallbladder: The gallbladder is of normal size and configuration. The wall is thin and the mucosa is bile-stained. It contains approximately 13 ml of bile. No calculi are present.

PANCREAS: The pancreas is firm and normally lobulated. Multiple cross sections through the pancreas reveal normal tan-yellow parenchyma without intrinsic lesions.

GENITOURINARY SYSTEM:

Kidneys: The right and left kidneys are similar. The capsules strip with ease to reveal smooth subcapsular surfaces. The renal arteries and veins are patent and free of stenosing lesions. On section, the renal cortices are of normal thickness and the cortico-medullary demarcations are distinct. The medullae are unremarkable. The pelvo-calyceal systems are normal in appearance. The ureters are unremarkable.

Bladder: The bladder is of normal configuration. The mucosa is intact and free of ulcerations or other lesions. It contains approximately 2 ml of urine.

Prostate and seminal vesicles: Multiple cross sections through the prostate reveal rubbery, firm, grey-white parenchyma, free of lesions. The seminal vesicles are unremarkable.

Testes: The testes are both present within the scrotal sac, and bivalve sections show normal parenchyma.

ENDOCRINE SYSTEM: No abnormalities are present in the pituitary, thyroid, or adrenal glands.

MUSCULOSKELETAL: The axial and appendicular skeleton show no abnormalities. The exposed musculature is unremarkable.

HEAD/BRAIN: The scalp shows no evidence of contusions or galeal hemorrhages. The skull is intact. The dura is smooth and glistening. The convexities of the cerebral hemispheres are symmetrical. The leptomeninges are thin and transparent. The subarachnoid space does not contain any hemorrhage. The cerebrum presents normal convolutions, with no flattening of the gyri or deepening or widening of the sulci. There is no evidence of subfalcial, uncal, or cerebellar tonsillar herniation present. The major cerebral arteries show no atherosclerosis or congenital anomalies. The roots of the cranial nerves are unremarkable. Serial coronal sections through the cerebral hemispheres show a grossly normal cortical ribbon and underlying white matter. The basal ganglia and diencephalon show no gross abnormalities. Serial cross sections through the brainstem and sagittal sections through the cerebellum fail to show any gross lesions or abnormalities. The ventricular system is symmetrical and of normal size and configuration. After removal of the brain, the base of the skull does not demonstrate any fractures.

SPINAL CORD: The spinal cord is smooth, tan-grey, and glistening, and serial cross sections through the spinal cord show no gross abnormalities.

Issue samples are retained and preserved, but are not submitted for histologic evaluation.

Detective Randy Divis and Detective Dan Nukta, both of the Cuyahoga County Sheriff's Office, were present during the autopsy.

This report was reviewed
by another CCMEO
board-certified
forensic pathologist.

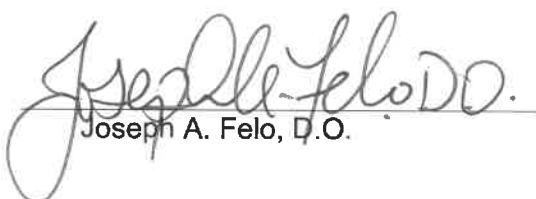
Joseph A. Felo, D.O.

Date

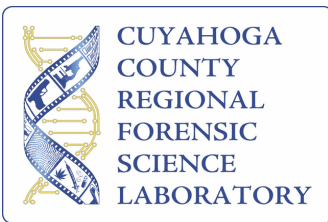

Cuyahoga County Regional Forensic Science Laboratory
11001 Cedar Avenue, Cleveland, Ohio 44106
Phone: (216) 721 5610 Fax: (216) 707 3123

Notification of Firearm Inspection

CCRFSL Case Number: 2021-003449 **Date:** 04/22/2021
Agency Case Number: 21015543
Agency Name: Cuyahoga County Sheriff Office
Agency Address: 1215 W. 3rd Street
Cleveland, OH 44113
Requested Analysis: Test Fire
Offense(s): Drug Trafficking
Lab Case #: 2021-003449
Request Number: 0002

The following evidence was submitted to the laboratory by Watson, Michael on 4/16/2021:

Evidence Item(s): 001 **Agency Item No:** 001

Description: *.556 CAL DEL-TON INC RIFLE SERIAL: DTI S188685*

Firearms Section Description: Del-Ton 5.56 X 45 mm caliber pistol. The correct serial number is S188685.

Package Type:	Box	Package Sealed:	Yes
Type:	Pistol	Action:	Semi-Automatic
Make:	Del-Ton	Model:	DTI 13
Caliber:	5.56 X 45 mm	Serial Number:	S188685
Country of Origin:	USA	Importer:	NA
Magazine Capacity:	30 round	Firearm Capacity:	31 rounds
Submitted Ammunition:	None		
Test Information:	Submitted magazine and six (6) rounds of laboratory stock ammunition used for test fire.		
Operating Condition:	Firearm was test fired without malfunction. (Operable)		
Test Samples:	Retained		
Item Status:	Retained		
NIBIN Case:	Yes		
Remarks:			

Analyst:

James Kooser

Witness: Koeth, Kristen

All activities related to this case were completed between the date the evidence was received, as noted on this document, and the document's issue date. Specific activity dates are maintained in the case file for this case.

Information displayed in *Italics* is data supplied by the submitting agency or entered by CCMEIO in-take personnel.

Results in this document relate only to the item(s) tested and apply to the item(s) as received.

This document shall not be reproduced except in full, without the written approval of the Cuyahoga County Regional Forensic Science Laboratory.

Cleveland, OH 2

Today Hourly 10 Day Weekend Monthly Radar Video

Monthly Weather - Cleveland, OH

As of 9:53 am EDT

< Mar Apr 2021 View May >

SUN	MON	TUE	WED	THU	FRI	SAT
28 ☁️🌧️ 51° 34°	29 ☀️☁️ 51° 44°	30 ☁️🌀 74° 52°	31 ☁️🌧️ 52° 29°	1 ☁️ 31° 26°	2 ☀️☁️ 39° 26°	3 ☀️☁️ 61° 45°
4 ☀️ 59° 40°	5 ☀️☁️ 71° 48°	6 ☀️☁️ 78° 58°	7 ☀️☁️ 78° 61°	8 ☁️🌧️ 85° 57°	9 ☀️☁️ 77° 58°	10 ☀️☁️ 82° 57°
11 ☁️🌧️ 64° 49°	12 ☁️🌧️ 58° 49°	13 ☀️ 61° 44°	14 ☀️☁️ 60° 40°	15 ☁️🌧️ 46° 41°	16 ☁️ 45° 38°	17 ☀️☁️ 49° 35°

Thu 15 | Day

46° ☁️🌧️

Record High
84°

Average High
59°

Sunrise
6:47 am

Sunset
8:07 pm

Thu 15 | Night

Almanac

Apr 20	High	Low	Precip
Averages	61°F	42°	--
Records	82° (2017)	23° (1904)	--

Reported Conditions

Yesterday	66°	40°	0.05 in
Last 7 Days	66°	35°	0.23
Month to Date	85°	26°	2.26

Historical Monthly Avg

April	59°	40°	3.49
May	70°	50°	3.66
June	79°	60°	3.43

Most Popular

Cold or Flu? 9 Ways to Tell the Difference

Which City Is the Worst for Fall Allergies This Year?

How Winter Fashion Has Changed in 100 Years (PHOTOS)

Eerie Vintage Photos of People Battling the Flu

41°



Record Low
22°



Average Low
40°



Moonrise
8:41 am



Moonset
11:46 pm

Waxing Crescent

18	19	20	21	22	23	24
59° 41°	66° 40°	44° 35°	40° 34°	46° 37°	59° 44°	61° 44°
25	26	27	28	29	30	1
52° 40°	60° 50°	74° 59°	76° 59°	67° 51°	62° 50°	62° 51°

Donate to the Covid-19 Solidarity Response Fund

Support WHO's work to track the spread; to ensure patients get care and frontline workers get supplies; and to accelerate efforts to develop vaccines, tests, and treatments.

[Donate Now](#)



Sponsored Content

6 Credit Cards You Should Not Ignore If You Have Excellent Credit

NerdWallet

Top 50 schools according to World University Rankings Report

Forbes

30 Odd Details You Missed In "Hogans Heroes"

Past Factory

Take This Quiz To See If You Can Retire Comfortably

SmartAsset

Get Outdoors with this Pop-Up Tent - On Sale Today!

Sponsored Content | The Weather Channel

Patrick Mahomes New Yacht Is A Floating Mansion

Definition.org

Amal Clooney's No Makeup Photo: Her Real Face Is Quite Different

Loan Insurance Wealth

by Taboola Sponsored Links

Connect With Us



[Feedback](#) [Careers](#) [Press Room](#) [Advertise With Us](#) [TV](#)

[Terms of Use](#) | [Privacy Policy](#) | [Ad Choices](#)  | [Data Vendors](#)



We recognize our responsibility to use data and technology for good. Take control of your data.

[Privacy Settings](#) | [Review My Advertising Settings](#) | [Data Rights](#)

© Copyright TWC Product and Technology LLC 2014, 2021

Powered by the



IBM Cloud



[Climate-Data.org](#) > [United States of America](#) > [Ohio](#) > [Cleveland](#) > [April](#)

CLEVELAND WEATHER AND CLIMATE IN APRIL



Are you planning a holiday with hopefully nice weather in Cleveland in April 2021?
about the weather in Cleveland in April:

>>[Overview: Cleveland Weather and Climate in April](#)

>>[Cleveland weather by month // weather averages](#)

>>[Cleveland weather in April // weather averages](#)

>>[Current temperature in Cleveland](#)



CONTINENTS

COUNTRIES

REGIONS

PLACES

TRAVEL

CLEVELAND WEATHER IN APRIL

	Temperature April	9°C 49°F		Precipitation / Rainfall April	2.7mm 0.1 inches
	Temperature April max.	13°C 56°F			
	Temperature April min.	5°C 41°F			

	Temperature April	9°C 49°F
	Temperature April max.	13°C 56°F



CONTINENTS

COUNTRIES

REGIONS

PLACES

TRAVEL

CLEVELAND WEATHER BY MONTH // WEATHER AVERAGES

	January	February	March	April	May	June	July	August	September	October	November	December
Avg. Temperature °C (°F)	-2.9 °C (26.8) °F	-2.2 °C (28.1) °F	2 °C (35.6) °F	8.9 °C (48.1) °F	15.7 °C (60.2) °F	20.9 °C (69.5) °F	23.1 °C (73.7) °F	22.4 °C (72.3) °F	19 °C (66.1) °F	12.5 °C (54.5) °F	6.2 °C (43.2) °F	0.6 °C (33.1) °F
Min. Temperature °C (°F)	-5.5 °C (22.1) °F	-5.1 °C (22.8) °F	-1.3 °C (29.7) °F	5 °C (41.1) °F	11.9 °C (53.4) °F	17.4 °C (63.3) °F	19.8 °C (67.6) °F	19.1 °C (66.5) °F	15.8 °C (60.4) °F	9.7 °C (49.4) °F	3.6 °C (38.5) °F	-1.7 °C (29) °F
Max. Temperature °C (°F)	0.7 °C (33.2) °F	2 °C (35.5) °F	6.6 °C (43.8) °F	14 °C (57.3) °F	20.3 °C (68.6) °F	25 °C (77) °F	27 °C (80.6) °F	26.1 °C (79) °F	23 °C (73.4) °F	16.3 °C (61.3) °F	9.8 °C (49.6) °F	3.6 °C (38.6) °F
Precipitation / Rainfall	89	73	86	107	103	117	107	92	90	92	90	94
mm (in)	(3.5)	(2.9)	(3.4)	(4.2)	(4.1)	(4.6)	(4.2)	(3.6)	(3.5)	(3.6)	(3.5)	(3.7)
Humidity(%)	75%	73%	73%	70%	71%	72%	71%	73%	73%	72%	74%	74%
Rainy days (d)	11	9	9	10	10	10	9					



CONTINENTS

COUNTRIES

REGIONS

PLACES

TRAVEL

[View deals](#) 

Opens new window



[CONTINENTS](#)[COUNTRIES](#)[REGIONS](#)[PLACES](#)[TRAVEL](#)**MONTHS**[Cleveland in January](#)[Cleveland in February](#)[Cleveland in March](#)[Cleveland in May](#)[Cleveland in June](#)[Cleveland in July](#)[Cleveland in August](#)[Cleveland in September](#)[Cleveland in October](#)[Cleveland in November](#)[Cleveland in December](#)

CLEVELAND WEATHER IN APRIL // WEATHER AVERAGES

beta

	Temperature (°C) (°F)	Temperature max. (°C) (°F)	Temperature min. (°C) (°F)	Precipitation / Rainfall (mm) (inch.)
1. April	8 °C 46 °F	12 °C 54 °F	4 °C 39 °F	2.3 mm 0.1 inch.
2. April	8 °C 46 °F	11 °C 52 °F	4 °C 39 °F	2.2 mm 0.1 inch.
3. April	8 °C 46 °F	13 °C 55 °F	3 °C 38 °F	2.5 mm 0.1 inch.
4. April	6 °C 43 °F	11 °C 51 °F	1 °C 34 °F	5.0 mm 0.2 inch.
5. April	5 °C 41 °F	9 °C 48 °F	1 °C 34 °F	3.4 mm 0.1 inch.
6. April	7 °C 45 °F	11 °C 53 °F	2 °C 36 °F	1.0 mm 0.0 inch.
7. April	7 °C 44 °F	11 °C 52 °F	3 °C 37 °F	3.4 mm 0.1 inch.
8. April	7 °C 45 °F	11 °C 52 °F	3 °C 38 °F	
9. April	7 °C 44 °F	11 °C 52 °F	3 °C 37 °F	
10. April	8 °C 46 °F	12 °C 54 °F	3 °C 38 °F	1.6 mm 0.1 inch.

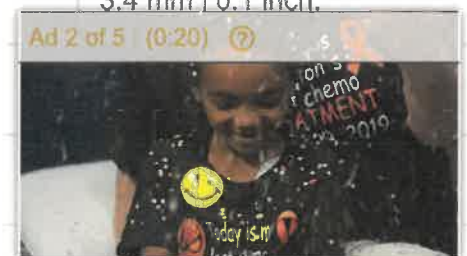

	CONTINENTS	COUNTRIES	REGIONS	PLACES	TRAVEL
15. April	11 °C 52 °F	16 °C 60 °F	6 °C 44 °F	3.7 mm 0.1 inch.	
16. April	11 °C 52 °F	16 °C 61 °F	6 °C 43 °F	3.9 mm 0.2 inch.	
17. April	10 °C 49 °F	13 °C 56 °F	6 °C 43 °F	2.6 mm 0.1 inch.	
18. April	11 °C 52 °F	15 °C 60 °F	7 °C 44 °F	0.3 mm 0.0 inch.	
19. April	12 °C 53 °F	17 °C 62 °F	7 °C 44 °F	0.8 mm 0.0 inch.	
20. April	11 °C 52 °F	16 °C 61 °F	6 °C 43 °F	4.3 mm 0.2 inch.	
21. April	10 °C 51 °F	14 °C 57 °F	7 °C 44 °F	2.9 mm 0.1 inch.	
22. April	10 °C 49 °F	13 °C 56 °F	6 °C 43 °F	2.2 mm 0.1 inch.	
23. April	10 °C 50 °F	14 °C 57 °F	6 °C 43 °F	2.7 mm 0.1 inch.	
24. April	10 °C 50 °F	15 °C 58 °F	5 °C 42 °F	2.2 mm 0.1 inch.	
25. April	11 °C 51 °F	15 °C 59 °F	6 °C 43 °F	2.7 mm 0.1 inch.	
26. April	11 °C 51 °F	15 °C 60 °F	6 °C 42 °F	6.1 mm 0.2 inch.	
27. April	10 °C 50 °F	14 °C 58 °F	6 °C 43 °F	1.9 mm 0.1 inch.	
28. April	10 °C 49 °F	14 °C 57 °F	5 °C 42 °F	1.3 mm 0.1 inch.	
29. April	10 °C 51 °F	14 °C 58 °F	6 °C 43 °F		
30. April	13 °C 55 °F	17 °C 63 °F	8 °C 47 °F		

Data: 1998 - 2018

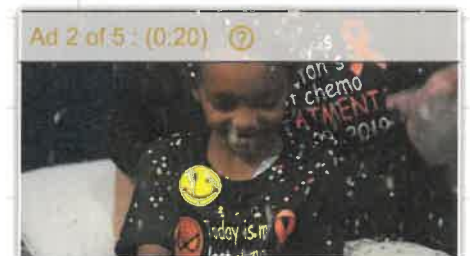

CLEVELAND AND CURRENT TEMPERATURE AND WEATHER

CONTINENTS	COUNTRIES	REGIONS	PLACES	TRAVEL			
19. April	Scattered clouds	18 °C 64 °F	6 °C 42 °F	35 %	18 km/h	0mm	64%
20. April	Overcast clouds	7 °C 44 °F	2 °C 36 °F	70 %	16 km/h	2mm	73%
21. April	Heavy snow	3 °C 37 °F	1 °C 33 °F	100 %	29 km/h	13mm	79%
22. April	Few clouds	8 °C 47 °F	2 °C 35 °F	20 %	15 km/h	0mm	57%
23. April	Scattered clouds	10 °C 51 °F	3 °C 37 °F	0 %	15 km/h	0mm	59%
24. April	Light rain	13 °C 55 °F	6 °C 42 °F	85 %	11 km/h		
25. April		9 °C 48 °F	4 °C 40 °F	70 %	18 km/h	2mm	



CONTINENTS	COUNTRIES	REGIONS	PLACES	TRAVEL			
26. April	Broken clouds	15 °C 60 °F	4 °C 39 °F	0 %	8 km/h	0mm	51%
27. April	Overcast clouds	22 °C 72 °F	11 °C 52 °F	0 %	22 km/h	0mm	67%
28. April	Broken clouds	23 °C 74 °F	16 °C 61 °F	0 %	22 km/h	0mm	72%
29. April	Broken clouds	22 °C 72 °F	16 °C 61 °F	0 %	23 km/h	0mm	69%
30. April	Light shower rain	18 °C 64 °F	6 °C 44 °F	75 %	22 km/h	3mm	78%
1. May	Few clouds	8 °C 46 °F	6 °C 42 °F	0 %	25 km/h		
2. May		13 °C 56 °F	5 °C 40 °F	0 %	8 km/h	0mm	



[CONTINENTS](#)

[COUNTRIES](#)

[REGIONS](#)

[PLACES](#)

[TRAVEL](#)

[ABOUT](#)

[LEGAL](#)

[Data sources](#)

[Imprint](#)

[Licensing](#)

[Privacy](#)

[Translations](#)

[Advertising](#)

© Climate-Data.org / AM OP / OpenStreetMap contributors

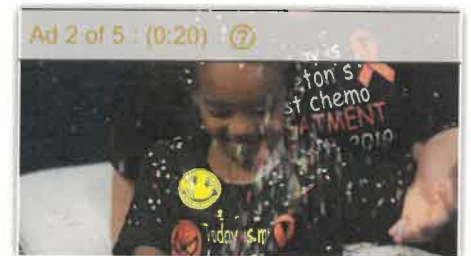



19 FIRST ALERT WEATHER / Wintry mix with snow accumulation possible on Wednesday

NEWS

Mother of Shaker Heights woman murdered allegedly by man shot and killed by police; says she had already forgiven him



Mother of Shaker Heights woman murdered allegedly by man shot and killed by police; says she had alr

By **Michelle Nicks** | April 16, 2021 at 10:27 PM EDT - Updated April 16 at 10:33 PM

CLEVELAND, Ohio (WOIO) - The man shot and killed by a Cleveland Police officer on Thursday was wanted for two crimes, including the murder of a Shaker Heights mother back on September 1st.

It's a bizarre twist of fate for 25-year-old Innes Lee, Jr. of Cleveland. Lee was shot and killed on Thursday when he pulled a gun on Cleveland Police. Bodycam video shows the intense moments. Officers were prepared to take him into custody on two separate crimes.

So, is this some form of justice for the family of murder victim Karen Hunter, or do they feel robbed of their day in court?

71-year-old Loretta Hunter says Karen was her youngest daughter and the second daughter to die from violence, "I wasn't robbed of my day in court because I wasn't going to go to court. I have been through this before when my oldest daughter (a mother of four) was murdered in 1997."

The Shaker Heights woman says she was not really surprised to hear that the man wanted for killing her youngest daughter was fatally shot and killed himself. Innes Lee, Junior died shortly after he pulled a gun on Cleveland police Thursday morning. It was all captured on police bodycam video. Officers wanted to take Lee into custody on two arrest warrants -- including Hunter's murder at a Sunoco Gas station on East 131st and Harvard Avenue. At the time of the shooting, Lee was actually free on bond from an aggravated robbery charge.

"He pulled a gun. I don't know if he had a death wish or what? You know they say you live by the sword, you die by the sword," Hunter said.

The Shaker Heights grandmother and great grandmother says she has already forgiven Lee for her daughter's death and decided not to sit through another court trial because reliving the pain hurts too much. That's why she has compassion for Lee's mother and family, "I feel for his mother, I feel for his children if he has them. Because I know what the loss of a child is and pray that she can live through if she is still living."

It's her daughter's life, kind heart, and generosity that Hunter says will endure after a violent death, "It's been very hard because I've had several illnesses, I've had cancer twice, and each time she's been my caregiver," her mother Loretta Hunter said.

Hunter says no matter what's happens; she'll have to accept it because nothing will bring her daughter back.

Copyright 2021 WOIO. All rights reserved.





AVOIDING NFL DRAFT TICKET SCAMS

READ MORE

NFL Draft tickets: High demand, low supply, making ripe scenario for scams



43°

Currently in Cleveland, OH

FULL FORECAST

Sponsored By

AUTHOR

Michelle Nicks (WOIO)

Multi-Media Journalist

Cleveland, OH





Michelle Nicks joined 19 News in March 2020.

She comes to Cleveland from WFMJ in Youngstown.

Michelle has been named Best Reporter by the Ohio Associated Press five times, including most recently in 2018, as well as being nominated for six Emmy Awards during her career.

RECENT CONTENT

FIRST ALERT: April Snowstorm on the way tonight

Cold today with light rain showers around

By **Jeff Tanchak**



▶ Lakewood to make safety changes after shootings at Madison Park

Lakewood city leaders and neighbors voiced their concerns about the recent shootings at Madison Park during a Public Safety committee and city council meeting Monday night.

By **Shannon Smith**

DAY FORECAST **19** FIRST ALERT WEATHER

CONFIRMED MOST ACCURATE

ALERT						
WED	THU	FRI	SAT	SUN	MON	TUE

▶ 19 First Alert weather: Snow returns weaneday with up to 3 inches possible

Published 4h at 11:09 PM



Woman involved in Mystique Moon theft wanted by Elyria Police

Published 5h at 10:56 PM



▶ Cleveland Ronald McDonald House mourns death of co-founder

Published 5h at 10:39 PM



'Now offering stimulus checks twice a month': Brunswick Wendy's has creative way of saying 'we're hiring'

Published 5h at 10:35 PM



4/20/2021

Mother of Shaker Heights woman murdered allegedly by man shot and killed by police; says she had already forgiven him

Cleveland, OH 44114

(216) 771-1943

[FCC APPLICATIONS](#) ▶

[EEO REPORT](#)

[CLOSED CAPTIONING](#)

[WOIO CAREERS](#)

[PRIVACY POLICY](#)

[TERMS OF SERVICE](#)

[CONTACT US](#)

[FCC PUBLIC FILE](#)

PUBLICFILE@WOIO.COM

(216) 367-7535



A Gray Media Group, Inc. Station - © 2002-2021 Gray Television, Inc.



Subscribe

Fact-forward journalism on demand. Subscribe now for instant access.

Advertisement

Metro

Man charged in fatal shooting of Shaker Heights woman at Cleveland gas station

Updated Oct 26, 2020; Posted Oct 26, 2020



Support local journalism that serves you.

Two men are accused of fatally shooting a man on the city's West Side.

317
shares

By [Adam Ferrise, cleveland.com](#)

CLEVELAND, Ohio — A 25-year-old man is accused of killing a Shaker Heights woman as he fired shots at a man who punched a different woman in the parking lot of a gas station in Cleveland's Union-Miles neighborhood.

Innes Lee Jr. of Cleveland is charged with aggravated murder. He is not in police custody and a warrant was issued for his arrest.

Lee is accused of fatally shooting [Karen Hunter](#), 48, on Sept. 1 at the Sunoco gas station on East 131st Street and Harvard Avenue.

Advertisement

Hunter was with a man at the gas station, when the man began arguing with someone in the parking lot. The other man punched a different woman in the face, according to court records.

Know when news breaks across Northeast Ohio.

Sign up for the free Breaking News email newsletter.

Email Address

Ex: user@mail.com

 Support local journalism that serves you.



MICHAEL C. O'MALLEY
CUYAHOGA COUNTY PROSECUTOR

May 18, 2021

Detective Joe Goudy
Detective John Gioitta
Cuyahoga County Sheriff's Office
Justice Center
1215 West 3rd Street
Cleveland, Ohio 44113

Re: Review of material regarding the use of deadly force by Cleveland Police Officer Daniel Piper on Innes Lee Jr.

On April 30, 2021, I was provided a sealed envelope containing a jump drive with Cleveland Police body camera footage. My task was to review the jump drive for material subject to the Supreme Court's decision in *Garrity v. New Jersey*, 385 U.S. 493 (1967), which prohibits the use of statements from a public employee in a criminal proceeding which were obtained under threat of removal from office. I have reviewed the original jump drive and 'cleaned' it of any *Garrity* material. The original jump drive contains *Garrity* material and is being returned in a sealed envelope. An unsealed jump drive is being provided with *Garrity*-free material.

The original jump drive contained three folders: "Body Camera Photos," "Body Camera Videos – Redacted," and "Body Camera Videos." The folder "Body Camera Photos" contained sixteen (16) images or photos. None of the images contained *Garrity* material and they are being provided on the unsealed jump drive without redactions. The folder "Body Camera Videos – Redacted" contained four videos with redactions not made by me. These videos do not contain *Garrity* material and they are being provided on the unsealed jump drive without additional redactions.

The folder "Body Camera Videos" contained fifty-one (51) videos. One video, entitled 4281_E_134_17_FIT_Questions_P_O_Piper, contained statements made by Officer Piper in connection with a *Garrity* warning. That video is not being provided on the unsealed jump drive. Of the other fifty (50) videos, sixteen (16) videos contained statements Officer Piper made to a superior officer after the shooting. In an abundance of caution, audio in those sixteen (16) videos is redacted and is provided on the unsealed jump drive. I redacted the following sixteen (16) videos and added the prefix "CLEAN" to the names of the original files:

CLEAN4281_E_134_Officer_Involved_Shooting__(1)
CLEAN13617_Beachwood_Fel_Susp_And_Foot_Pursuit
CLEAN13617_Beachwood_Male_with_warrant_shots_Homicide_IA_
CLEAN13617_Beachwood_Trouble_Unknown_Officer_Shooting
CLEANA_O_E_131_Beachwood_Touring_for_Homicide_Suspect
CLEANAssist_ZC_C_W_Homicide_Suspect__OIS_4281_E_134
CLEANAssist_ZC_C_W_Homicide_Suspect__OIS_4281_E_134
CLEANAXON_Body_2_Video_2021-04-15_0805(1)
CLEANAXON_Body_2_Video_2021-04-15_0805(2)
CLEANAXON_Body_2_Video_2021-04-15_0805
CLEANAXON_Body_2_Video_2021-04-15_0810(1)
CLEANAXON_Body_2_Video_2021-04-15_0810(2)
CLEANAXON_Body_2_Video_2021-04-15_0810
CLEANE_134_Beachwood_Police_involved_shootg_County_to_handle
CLEANE134_Officer_Involved_Shooting_Asst
CLEANE134_OIS

The other thirty-four (34) videos are also being provided on the unsealed jump drive without redactions.

On May 13, 2021, I received five documents from the City of Cleveland through the Cleveland Public Records Center. These documents consist of Officer Daniel Piper's personnel file. I combined these documents into a single document entitled CPD Piper Personnel File. That file is free of *Garrity* material and is contained within the unsealed jump drive.

Also, on May 13, 2021, I received a sealed envelope from Detective Gioitta containing a two-page report dated April 19, 2021 and authored by Cleveland Police Detective Michael Hale. Those documents contain no information implicating *Garrity* and are being provided in their original form.

Finally, on May 17, 2021, I received a sealed envelope from Detective Gioitta containing paper documents. They include a two-page summary of a violation charged against Officer Piper in 2016. The violation was dismissed and there is no content describing the incident. It does not implicate *Garrity*. The sealed envelope also contains a three-page document listing the daily duty assignments of the officers in the Cleveland Police Fourth District. This document also does not implicate *Garrity*.

Please provide my name to any assistant prosecuting attorney who presents this case to a grand jury so that I may be screened from the case.

Respectfully,

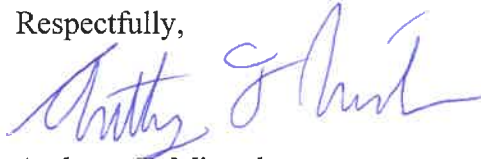

Anthony T. Miranda
Assistant Prosecuting Attorney

*Please sign and date below to acknowledge your receipt of (1) a copy of this letter, (2) the unsealed jump drive, (3) the sealed envelope containing the original jump drive, (3) the two-page April 19, 2021 report of Cleveland Police Detective Michael Hale, (4) the two-page summary of a 2016 violation, and (5) the three-page summary of Cleveland Police Fourth District daily duty assignments.

Acknowledgment:



Detective John Gioitta
Cuyahoga County Sheriff's Office

05/18/21

Date